



EDICION 01/2017

CINCOCCINA.COM

INDICE DE MODELOS

MODELO	DESCRIPCION	TARIFA	PAGINA
SUIZA	MELAMINA 19 mm. (4 CANTOS)	100	1
FLORIDA	MELAMINA 19 mm. (4 CANTOS PVC. A JUEGO)	150	1
ALABAMA	MELAMINA 19 mm. (4 CANTOS PVC. A JUEGO)	200	1
BOSTON (novedad)	MELAMINA 19 mm. (4 CANTOS PVC. A JUEGO)	200	1
TORONTO	MELAMINA 19 mm.ACABADO PIEDRA (4 CANTOS PVC JUEGO)	200	2
LOIRA	MELAMINA 19 mm. (4 CANTOS PVC. A JUEGO)	201	2
ALABAMA CANTO ALUMINIO	MELAMINA 19 mm. (4 CANTOS ALUMINIO MACIZO)	201	2
CANADA	MELAMINA 19 mm.ACABADO PINO (4 CANTOS PVC JUEGO)	201	2
PARIS	MELAMINA 19 mm. (4 CANTOS PVC) CASCO GRIS	300	2
SIL	MELAMINA 19 mm. (4 CANTOS PVC) PORO REGISTRO	300	2
MIÑO BLANCO PVC JUEGO	LAMINADO BLANCO 19 mm. (4 CANTOS PVC A JUEGO)	300	3
MIÑO BLANCO PVC CRISTAL	LAMINADO BLANCO 19 mm. (4 CANTOS ACRILICO CRISTAL)	300	3
LUGO	LAMINADO BLANCO MATE 19 mm. (4 CANTOS PVC JUEGO)	300	3
MIÑO COLORES PVC JUEGO	LAMINADO COLORES 19 mm. (4 CANTOS PVC A JUEGO)	400	3
MIÑO COLORES PVC CRISTAL	LAMINADO COLORES 19 mm. (4 CANTOS ACRILICO CRISTAL)	400	3
LUXEMBURGO PVC JUEGO (novedad)	SOPORTE MDF MELAMINIZADO LACADO ALTO BRILLO	400	3
MIÑO BLANCO CANTO ALUMINIO	LAMINADO BLANCO 19 mm.(4 CANTOS ALUMINIO)	400	4
MIÑO COLORES CANTO ALUMINIO	LAMINADO 19 mm. (4 CANTOS ALUMINIO MACIZO)	401	4
MODELOS POLILAMINADOS	POLILAMINADO	500	4
TURIN	PET (5 COLORES) MATE	500	5
VICTORIA	LAMINADO COLORES 19 mm.(CONTRACARA + PVC A JUEGO CASCO)	500	5
NAPOLES	MELAMINA ENMARCADA (3 COLORES)	502	5
MILAN	PET (7 COLORES) BRILLO Y MATE	502	5
JANDULA LACADO BLANCO BRILLO	LACADO BLANCO BRILLO - MATE	502	6
ZAIRE LACADO BLANCO BRILLO	LACADO BLANCO BRILLO - MATE	502	6
JANDULA LACADO COLORES	LACADO COLORES BRILLO - MATE	503	6
ZAIRE LACADO COLORES	LACADO COLORES BRILLO - MATE	503	6
CONGO	PUERTA RECHAPADA EN CEREZO	600	6
TURIA	PUERTA CHAPA PREFABRICADA, CANTO MACIZO 3 mm.	600	6
SENA	PUERTA MARCO ROBLE MACIZO Y PLAFON RECHAPADO	600	6
ELBA	MARCO ROBLE MACIZO Y PLAFON RECHAPADO CON TARUGOS	601	7
ADRA	MARCO ROBLE MACIZO Y PLAFON RECHAPADO PROVENZAL	601	7
DEVA	MARCO ROBLE MACIZO Y PLAFON RECHAPADO	601	7
EBRO	MARCO ROBLE MACIZO Y PLAFON RECHAPADO ENVEJECIDO	601	7
NARCEA	PUERTA MARCO ALDER MACIZO Y PLAFON RECHAPADO FORMA	602	7
GANGES	PUERTA CHAPADA ROBLE SOBRE TABLERO MARINO TIR. UÑERO	602	5
NARCEA	PUERTA MARCO ALDER MACIZO Y PLAFON RECHAPADO FORMA	602	7

CINCOGINA S.L.

Telefono- 953 350240

Ctra. Ubeda-Malaga km. 37,300

Fax - 953 350357

23100 Mancha Real (Jaen)

Mail- pedidos@cincocina.com ; cincocina@cincocina.com

SUIZA MELAMINA 19 mm. (4 CANTOS) TARIFA 100

COLORES

CASCO BLANCO



fresno gris

VETA HORIZONTAL



Nogal claro

VETA HORIZONTAL



Blanco



Crema



Roble natural

VETA VERTICAL



Roble trufa

VETA VERTICAL



gris luna

FLORIDA MELAMINA 19 mm. (4 CANTOS PVC) TARIFA 150

COLORES

CASCO BLANCO

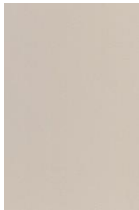

Beig rosado



Roble

VETA HORIZONTAL



Cerezo silvestre

VETA HORIZONTAL

ALABAMA MELAMINA 19 mm. (4 CANTOS PVC) TARIFA 200

COLORES

CASCO BLANCO



Driftwood

VETA HORIZONTAL

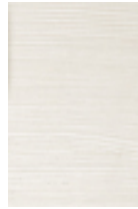

Woodline Crema

VETA HORIZONTAL



Woodline Café

VETA HORIZONTAL



Hacienda blanco

VETA HORIZONTAL



Blanco Premium



Roble gris

VETA VERTICAL



Wengue de Mali

VETA VERTICAL



Roble marron

VETA VERTICAL

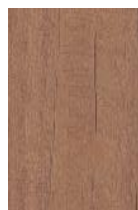

Pino rustico oscuro

VETA VERTICAL



Granate

BOSTON MELAMINA 19 mm. (4 CANTOS PVC) TARIFA 200

CASCO BLANCO



Gris Artico



Roble Nebraska

VETA VERTICAL



Madera Blanca

VETA VERTICAL



Pino Havana

VETA VERTICAL



Roble Antiguo

VETA VERTICAL



Pino Aland

VETA VERTICAL



Arce Natural

VETA VERTICAL



Pino champan

VETA VERTICAL



Arce Americano

VETA VERTICAL



Pino Ceniza

VETA VERTICAL



Azul Tiffany



Azul Ahumado

TORONTO MELAMINA 19 mm.ACABADO PIEDRA (4 CANTOS PVC) TARIFA 200

COLORES

CASCO BLANCO

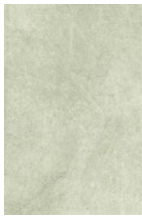

Cemento Claro

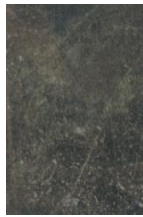

Cemento oscuro

LOIRA MELAMINA 19 mm. (4 CANTOS PVC) TARIFA 201

COLORES

CASCO BLANCO



Roble blanco

VETA VERTICAL



Roble medio

VETA VERTICAL



Roble ceniza

VETA VERTICAL

CANADA MELAMINA 19 mm ACABADO VETA MADERA. (4 CANTOS) TARIFA 201

COLORES

CASCO BLANCO



Pino blanco

VETA VERTICAL



Pino decape

VETA VERTICAL

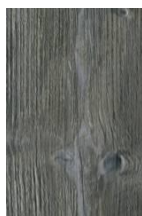

Pino Jackson

VETA VERTICAL

ALABAMA ALUMINIO MELAMINA 19 mm.(4 CANTOS ALUMINIO) TARIFA 201

CASCO BLANCO

MISMOS COLORES Y DISEÑOS QUE LA TARIFA 200

PARIS MELAMINA 19 mm. (4 CANTOS PVC) CASCO GRIS TARIFA 300

COLORES

CASCO GRIS



Arcilla

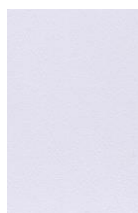

Blanco

SIL MELAMINA 19 mm. (4 CANTOS PVC) PORO REGISTRO TARIFA 300

COLORES

CASCO BLANCO

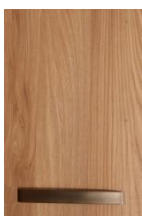

Nogal claro

VETA VERTICAL

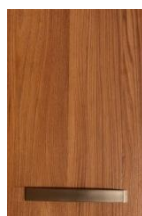

Nogal oscuro

VETA VERTICAL



Natural

VETA VERTICAL



Gris

VETA VERTICAL

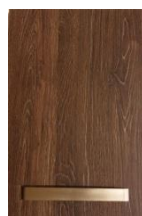

Wengue

VETA VERTICAL



Roble blanco

VETA VERTICAL

MIÑO BLANCO PVC	LAMINADO BLANCO 19 mm. (4 CANTOS PVC)	TARIFA	300
MIÑO BLANCO CRISTAL	LAMINADO BLANCO 19 mm. (4 CANTOS PVC CRISTAL)	TARIFA	300

COLORES

CASCO BLANCO



Blanco brillo

LUGO	LAMINADO MATE 19 mm. (4 CANTOS PVC)	TARIFA	300
-------------	--	---------------	------------

CASCO BLANCO



Blanco



Ciclone



Tierra



Burdeos

MIÑO COLORES PVC	LAMINADO COLORES 19 mm. (4 CANTOS PVC A JUEGO)	TARIFA	400
MIÑO COLORES CRISTAL	LAMINADO COLORES 19 mm. (4 CANTOS ACR. CRISTAL)	TARIFA	400

COLORES

CASCO BLANCO



Rosa chicle



Granate



Azul oscuro

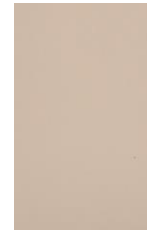

Vison



Verde pistacho



Berengena

LUXEMBURGO PVC JUEGO	SOPORTE MDF MELAMINIZADO LACADO ALTO BRILLO	TARIFA	400
-----------------------------	--	---------------	------------

COLORES

CASCO BLANCO



Blanco



Crema



Gris claro



Arena



Amarillo

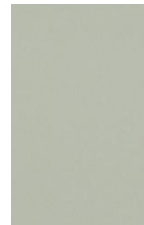

Almendra



Aguamarina



Negro



Azul



Rojo



Marengo

MIÑO BLANCO CANTO ALUM.	LAM.BLANCO 19 mm.(4 CANTOS ALUMINIO)	TARIFA	400
COLORES		CASCO BLANCO	
Blanco Brillo	CANTO ALUMINIO MACIZO		

MIÑO COLORES CANTO ALUM.	LAMINADO 19 mm(4 CANTOS ALUMINIO)	TARIFA	401
		CASCO BLANCO	
MISMOS COLORES Y DISEÑOS QUE LA TARIFA 400			

MODELOS POLILAMINADOS	POLILAMINADO(COLORES MUESTRARIO MATE)	TARIFA	500
		CASCO BLANCO	



TER



ESTOLA



TAJO



TAMBRE



LINE



APOLO



ZEUS



ESTOLA SIN RAYAS

PARA ESTA SERIE TENEMOS UN MUESTRARIO COMPLETO DE COLORES

VICTORIA LAMINADO COLORES 19 mm. (PVC A JUEGO CASCO) TARIFA 500

CASCO DISEÑO
CARIBE



COLORES

- Blanco
- Burdeos
- Magnolia

PATA NORMAL
COLGADOR NORMAL

CONTRACARA DE LA PUERTA A JUEGO CON EL COLOR DEL CASCO

NAPLES MELAMINA ENMARCADA DE 22 MM TARIFA 502



COLORES



Wengue



Medio



Blanco

TURIN PET (5 COLORES) MATE TARIFA 500

MILAN PET (5 COLORES) MATE (2 COLORES) BRILLO TARIFA 502

CASCO BLANCO



TURIN



MILAN

JANDULA LACADO BLANCO	LACADO BLANCO BRILLO - BLANCO MATE	TARIFA	502
ZAIRE LACADO BLANCO	LACADO BLANCO BRILLO - BLANCO MATE	TARIFA	502

CASCO BLANCO



JANDULA BLANCO

ZAIRE BLANCO

JANDULA LACADO COLORES	LACADO COLORES BRILLO - MATE	TARIFA	503
ZAIRE LACADO COLORES	LACADO COLORES BRILLO - MATE	TARIFA	503

CASCO BLANCO



JANDULA COLOR

ZAIRE COLOR

MADERAS 0	PUERTA MADERA S/MODELO	TARIFA	600
-----------	------------------------	--------	-----

CASCO DISEÑO



CONGO
COLORES

Cerezo



SENA

COLORES
Natural
Nogal
Nogal difumin.



TURIA

COLORES
Cobre
Ceniza
Natural
Caoba glas.
Cerezo

ANDARAX	LACADO BLANCO MATE	TARIFA	601
---------	--------------------	--------	-----

CASCO BLANCO



ANDARAX BLANCO

MADERAS 1

PUERTA DE MADERA S/ MODELO

TARIFA

601

CASCO DISEÑO



ELBA

COLORES

Nogal glaseado



ADRA

COLORES

Arena glaseado



DEVA

COLORES

Cobre patinado



EBRO

COLORES

Nogal glaseado

MADERAS 2

PUERTA DE MADERA S/ MODELO

TARIFA

602

CASCO DISEÑO



PISUERGA

COLORES

Cerezo

Maple natural



VISTULA

COLORES

Hueso



NARCEA

COLORES

Cerezo

Puertas 90 alto 2 plafones



GANGES

COLORES

Nogal

BAJOS																
BAJOS																
TARIFA																
REF.	ANCHO		100	150	200	201	300	400	401	500	502	503	600	601	602	
	B	25	80	82	85	87	94	97	102	105	127	136	158	170	194	
	B	30	83	85	88	90	98	102	107	113	129	138	160	172	196	
	B	35	87	89	92	94	103	108	113	121	133	142	166	179	207	
	B	40	90	92	95	98	107	113	119	128	138	147	171	184	216	
	B	45	96	98	101	104	115	121	127	139	149	159	180	194	229	
	B	50	99	102	105	108	120	126	133	147	157	168	186	201	238	
	B	60	1P	107	110	113	117	130	138	145	164	176	189	199	222	260
1 PUERTA																
	B	60	120	125	129	134	150	158	169	179	212	229	267	291	339	
	B	70	129	135	139	144	161	170	182	197	222	240	279	306	361	
	B	80	136	142	146	152	171	182	194	212	233	251	291	318	381	
	B	90	141	147	152	158	179	191	204	228	248	268	302	329	400	
	B	100	149	156	161	168	191	204	218	246	266	288	316	347	421	
	2 PUERTAS															
FREGADEROS																
REF.	ANCHO	ALTO	100	150	200	201	300	400	401	500	502	503	600	601	602	
	SF	45	85	88	91	94	104	110	117	128	139	149	167	180	215	
	SF	50	87	90	93	96	108	115	121	135	145	156	171	186	223	
	SF	60	1P	92	95	98	102	115	123	130	149	161	174	180	203	241
	CON BANDEJA															
	SFB	45		103	106	109	112	122	128	135	146	157	167	185	198	233
	SFB	50		107	110	113	116	128	135	141	155	165	176	191	206	243
	SFB	60	1P	115	117	121	125	138	146	153	172	184	197	203	226	264
1 PUERTA																
	SF	60	105	112	115	119	135	143	154	164	197	214	248	272	320	
	SF	70	110	116	120	125	142	152	163	178	203	221	256	283	338	
	SF	80	115	122	126	131	151	161	174	192	212	230	266	292	355	
	SF	90	120	127	131	137	158	170	183	206	227	247	275	302	373	
	SF	100	125	133	137	143	166	180	194	221	241	263	285	316	390	
	SF	120	146	157	162	170	199	215	234	261	291	319	368	407	502	
	CON BANDEJA															
	SFB	60		128	134	138	142	158	166	177	187	220	237	271	295	343
	SFB	70		135	141	145	150	167	177	188	203	228	246	281	308	363
	SFB	80		142	148	153	158	178	188	201	219	239	257	293	319	382
	SFB	90		149	155	160	166	187	199	212	235	256	276	304	331	402
SFB	100		156	163	168	174	197	211	225	252	272	294	316	347	421	
2 PUERTAS																
	SF	135	154	165	170	179	211	229	248	283	314	344	383	423	529	
	3 PUERTAS															
SOPORTE PLACA																
REF.	ANCHO	ALTO	100	150	200	201	300	400	401	500	502	503	600	601	602	
	SP	60	1P	102	104	107	111	124	131	138	156	167	180	189	211	247
	1 PUERTA															
	SP	60		114	119	123	127	143	150	161	170	201	218	254	276	322
	2 PUERTAS															
SOPORTE PLACA-HORNO																
REF.	REF.	REF.	100	150	200	201	300	400	401	500	502	503	600	601	602	
	SPH	60		76	75	77	82	85	91	95	98	105	110	111	114	121
	SPHR	60		80	80	80	80	80	80	80	80	80	80	89	89	89
	(con rejilla ventilación)															
	SPHCZ	60		216	216	217	222	225	231	235	238	245	250	251	254	261
(cajon bajo zocalo)																
SOP. PLACA-HORNO CON CACEROLERO																
REF.	ANCHO	ALTO	100	150	200	201	300	400	401	500	502	503	600	601	602	
	BHCM	60	METAL	145	148	150	152	160	165	171	176	189	197	222	240	265
	BHCA	60	FRENO	182	185	187	190	198	202	208	214	226	235	260	278	302

LOS MUEBLES BAJOS SE PUEDEN HACER CON UNA ALTURA DE 80 CM
EL INCREMENTO SERIA DE UN 15% SOBRE EL MUEBLE NORMAL DE 70 DE ALTURA

BAJOS																
BAJO RINCON																
	REF.	ANCHO	ALTO	TARIFA												
				100	150	200	201	300	400	401	500	502	503	600	601	602
	RB	90		149	155	160	166	187	199	212	220	240	260	294	321	392
	RB	100		157	164	169	176	199	212	226	238	258	280	308	339	413
	RB	120		174	184	190	198	227	243	262	273	303	331	380	419	514
RB	135		182	192	198	207	239	257	276	295	326	356	395	435	541	
BAJO RINCON ANGULAR																
	REF.	ANCHO	ALTO	100	150	200	201	300	400	401	500	502	503	600	601	602
	RBA	90x 90		225	228	235	249	269	276	294	300	355	384	393	427	467
	RBA	100x 100		254	256	264	282	306	312	343	355	392	424	430	476	517
BOTELLERO PANERO CROMO - FRENO																
	REF.	ANCHO	ALTO	100	150	200	201	300	400	401	500	502	503	600	601	602
	BB	15		223	221	228	230	237	240	245	248	270	279	301	313	337
	BBP	30		259	256	264	266	274	278	283	289	305	314	336	348	372
	BBP	40		273	270	278	281	290	296	302	311	321	330	354	367	399
TERMINAL BAJO																
	REF.	ANCHO	ALTO	100	150	200	201	300	400	401	500	502	503	600	601	602
	TB	30		88	96	99	107	131	150	166	173	187	196	189	189	189
TERM.BAJO PUERTA																
	REF.	ANCHO	ALTO	100	150	200	201	300	400	401	500	502	503	600	601	602
	TBP	30		166	180	186	205	222	238	259	265	324	350	426	459	507
SOP.FREGADERO 60																
PTA EXTRAIBLE																
1 CACER.INTERIOR		ATIRA														
	REF.	ANCHO	ALTO	100	150	200	201	300	400	401	500	502	503	600	601	602
	SFC	60	1P	184	186	189	193	206	213	220	238	249	262	271	293	329

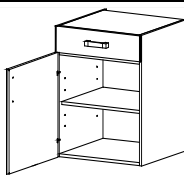
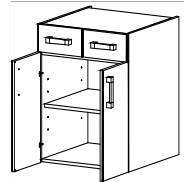
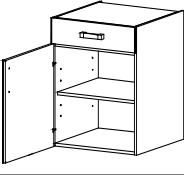
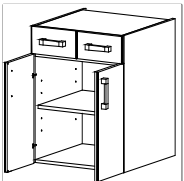
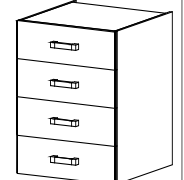
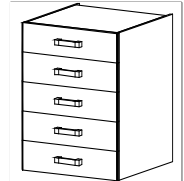
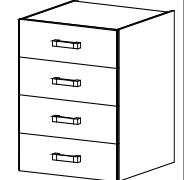
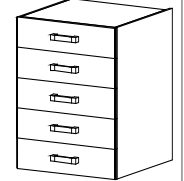
BAJOS															
BAJOS CON CAJON METALICO															
REF.	ANCHO	ALTO	TARIFA												
	B1CM	25	100	150	200	201	300	400	401	500	502	503	600	601	602
	B1CM	30	110	114	118	121	130	134	143	145	182	195	211	220	255
	B1CM	35	114	118	122	124	134	138	146	148	185	199	215	224	259
	B1CM	40	118	122	126	129	139	144	153	156	191	205	224	232	270
	B1CM	45	122	127	131	134	145	151	160	163	196	210	232	240	282
	B1CM	50	130	135	139	142	155	161	171	175	207	221	245	253	297
	B1CM	60	133	140	144	147	161	168	179	183	213	228	253	260	310
	B1CM	60	143	148	153	157	173	181	192	202	233	250	270	281	335
1 PUERTA 1 CAJON MET.															
REF.	ANCHO	ALTO	TARIFA												
	B2CM	60	174	184	190	195	214	222	239	241	318	344	370	388	457
	B2CM	70	184	194	200	206	227	236	254	257	330	357	387	404	480
	B2CM	80	192	204	210	217	240	250	269	274	342	370	406	421	506
	B2CM	90	203	214	221	228	253	265	286	294	357	386	426	440	530
	B2CM	100	211	224	231	239	266	279	302	311	370	400	443	457	557
2 PUERTA 2 CAJONES MET.															
REF.	ANCHO	ALTO	TARIFA												
	B1CA	25	147	150	155	157	167	171	179	181	219	232	249	258	292
	B1CA	30	147	153	158	161	170	174	183	185	222	235	253	262	296
	B1CA	35	150	158	163	166	176	181	189	193	228	241	261	269	308
	B1CA	40	155	162	167	171	182	187	197	201	233	247	270	278	320
	B1CA	45	158	171	176	179	192	198	208	212	244	258	283	291	335
	B1CA	50	167	176	181	185	198	205	216	221	250	265	292	299	348
	B1CA	60	171	185	191	195	211	219	230	239	271	288	309	319	374
1 PUERTA 1 CAJON FRENO															
REF.	ANCHO	ALTO	TARIFA												
	B2CA	60	247	254	262	268	287	295	312	315	390	417	445	463	532
	B2CA	70	258	265	273	279	300	309	327	332	403	430	463	479	556
	B2CA	80	266	275	284	290	313	324	342	348	415	443	482	497	582
	B2CA	90	277	286	295	302	327	339	360	368	431	460	502	516	606
	B2CA	100	286	297	306	314	341	354	376	385	445	475	520	534	633
2 PUERTA 2 CAJONES FRENO															
REF.	ANCHO	ALTO	TARIFA												
	BTCM	25	180	187	193	197	210	215	228	221	287	308	283	284	310
	BTCM	30	185	192	198	202	216	220	234	227	293	313	290	290	316
	BTCM	35	192	199	205	209	224	229	243	237	302	322	304	309	322
	BTCM	40	200	210	216	220	237	242	257	249	312	333	320	324	340
	BTCM	45	212	221	228	233	250	257	276	265	331	353	340	348	352
	BTCM	50	217	229	236	242	260	267	287	274	338	361	353	362	368
	BTCM	60	232	243	251	258	279	287	307	296	354	378	376	384	393
4 CAJONES MET.															
REF.	ANCHO	ALTO	TARIFA												
	BTC5M	25	209	218	225	229	245	249	266	260	342	367	338	349	371
	BTC5M	30	209	224	231	235	251	255	272	266	348	373	345	356	378
	BTC5M	35	215	232	239	243	260	265	282	278	358	383	362	378	384
	BTC5M	40	223	243	251	256	274	279	297	292	369	395	381	396	406
	BTC5M	45	231	257	265	270	289	296	319	311	392	420	405	417	419
	BTC5M	50	245	266	274	280	301	308	331	322	401	429	421	430	439
	BTC5M	60	251	282	291	298	321	329	354	348	419	448	447	454	468
5 CAJONES MET.															
REF.	ANCHO	ALTO	TARIFA												
	BTCA	25	334	337	347	351	365	369	383	376	442	462	438	448	464
	BTCA	30	340	342	353	356	370	374	388	381	447	467	444	455	470
	BTCA	35	347	349	360	364	379	384	398	392	456	477	459	474	477
	BTCA	40	356	361	372	376	392	398	412	405	467	488	476	490	496
	BTCA	45	368	372	384	389	407	413	432	421	487	509	496	508	508
	BTCA	50	375	382	394	399	418	425	444	432	496	519	511	520	525
	BTCA	60	392	399	411	417	438	447	467	456	514	537	535	543	552
4 CAJONES FRENO															
REF.	ANCHO	ALTO	TARIFA												
	BTC5A	25	402	405	418	422	437	442	458	453	535	559	531	542	564
	BTC5A	30	408	411	424	428	443	448	464	459	541	566	538	548	570
	BTC5A	35	416	419	432	437	453	458	476	472	552	577	555	572	578
	BTC5A	40	426	432	445	450	468	474	491	487	564	590	575	590	601
	BTC5A	45	441	446	460	466	485	491	515	506	588	615	600	613	615
	BTC5A	50	449	458	472	478	498	505	529	519	598	627	618	627	636
	BTC5A	60	467	475	490	497	520	528	553	547	618	647	646	654	667
5 CAJONES FRENO															

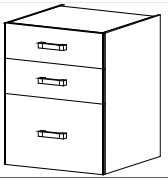
BAJOS																	
VERD. 2 CAJONES METALICO																	
	REF.	ANCHO	ALTO	TARIFA													
				100	150	200	201	300	400	401	500	501	502	503	600	601	602
	BVM	40		196	203	209	213	227	233	245	238	289	285	302	333	343	379
	BVM	45		206	212	219	224	239	246	261	253	305	301	320	349	360	392
	BVM	50		214	222	229	234	251	258	273	265	320	315	334	361	373	408
	BVM	60		231	239	246	252	271	279	296	290	349	338	359	382	394	434

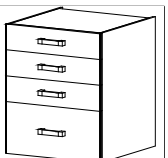
VERD. 3 CAJONES METALICO																
	REF.	ANCHO	ALTO	100	150	200	201	300	400	401	500	502	503	600	601	602
		BV3M	40		223	233	240	244	261	266	281	272	333	354	390	400
	BV3M	45		235	244	252	257	275	281	301	289	355	378	410	421	456
	BV3M	50		244	255	263	269	288	295	315	303	369	393	425	437	475
	BV3M	60		262	274	282	288	309	318	339	331	397	423	450	462	505

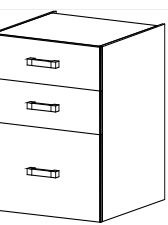
VERD. 2 CAJONES FRENO																
	REF.	ANCHO	ALTO	100	150	200	201	300	400	401	500	502	503	600	601	602
		BVA	40		315	319	329	333	349	356	367	363	409	426	452	457
	BVA	45		327	330	340	345	362	369	385	379	426	445	468	476	528
	BVA	50		333	338	348	353	370	377	393	384	434	443	480	486	537
	BVA	60		351	355	366	371	390	399	415	410	458	478	502	507	553
	BVA	70		390	381	393	400	421	431	449	450	532	561	561	578	649
	BVA	80		408	400	412	419	442	454	472	476	589	625	603	612	675
	BVA	90		432	422	435	443	469	482	504	508	646	687	633	649	703
	BVA	100		451	441	455	464	492	506	529	538	693	737	687	700	748
	BVA	120		486	476	491	501	534	551	577	596	753	801	745	765	803

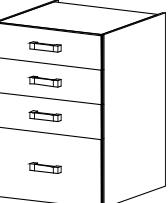
VERD. 3 CAJONES FRENO																
	REF.	ANCHO	ALTO	100	150	200	201	300	400	401	500	502	503	600	601	602
		BV3A	40		381	386	398	403	419	425	440	430	492	513	549	560
	BV3A	45		394	399	411	416	434	440	460	449	514	537	569	578	615
	BV3A	50		404	410	423	429	447	455	475	463	529	553	585	590	635
	BV3A	60		423	429	442	449	470	478	499	491	557	583	610	635	666
	BV3A	70		474	462	476	484	507	517	540	536	657	694	692	713	793
	BV3A	80		494	482	497	506	532	543	566	565	724	769	744	763	831
	BV3A	90		522	510	526	535	563	576	604	602	789	840	781	811	867
	BV3A	100		545	533	549	559	589	604	632	634	842	898	850	870	917
	BV3A	120		586	573	591	602	638	655	689	698	912	972	892	930	985

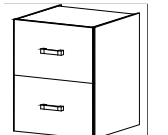
BAJOS																
CACEROLERO METALICO																
	REF.	ANCHO	ALTO	100	150	200	201	300	400	401	500	502	503	600	601	602
		BCCM	40		180	183	189	193	205	211	219	224	243	256	331	361
	BCCM	45		188	192	198	201	215	221	232	237	257	270	342	371	416
	BCCM	50		197	201	207	212	226	233	244	251	274	289	351	381	430
	BCCM	60		213	216	223	228	244	253	265	276	301	318	368	404	453

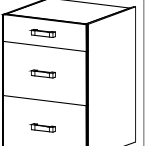
CACEROLERO 1 CAJON METALICO																
	REF.	ANCHO	ALTO	100	150	200	201	300	400	401	500	502	503	600	601	602
		BCCCM	40		213	220	227	231	245	251	263	259	292	308	395	423
	BCCCM	45		224	230	237	242	257	264	280	275	312	330	410	436	487
	BCCCM	50		233	242	249	253	270	277	293	289	330	349	421	449	504
	BCCCM	60		251	258	266	271	290	299	316	316	365	386	442	474	531

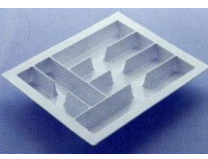
	I.CUB30	CUBTERO 30	GRIS	10
	I.CUB35	CUBTERO 35	GRIS	11
	I.CUB40	CUBTERO 40	GRIS	12
	I.CUB45	CUBTERO 45	GRIS	13
	I.CUB50	CUBTERO 50	GRIS	13
	I.CUB60	CUBTERO 60	GRIS	15
	I.CUB60	CUBTERO 70	GRIS	45
	I.CUB60	CUBTERO 80	GRIS	47
	I.CUB90	CUBTERO 90	GRIS	48
	I.CUB100	CUBTERO 100	GRIS	52
	I.CUB120	CUBTERO 120	GRIS	56

BAJOS																	
CACEROLERO FRENO		REF.	ANCHO	100	150	200	201	300	400	401	500	502	503	600	601	602	
	BCCA	40		256	258	266	269	282	287	296	301	319	333	407	437	479	
	BCCA	45		266	267	275	279	292	298	310	315	334	347	419	449	493	
	BCCA	50		273	275	284	288	302	309	321	327	350	365	427	458	506	
	BCCA	60		288	289	298	303	320	328	340	351	376	394	443	480	528	
	BCCA	70		316	309	319	324	343	353	366	393	434	457	463	488	539	
	BCCA	80		333	326	336	342	363	374	388	420	491	522	499	514	566	
	BCCA	90		350	343	354	361	384	396	413	448	550	587	520	557	582	
	BCCA	100		367	360	371	379	403	418	434	482	616	660	610	650	682	
	BCCA	120		396	389	401	410	439	456	473	547	693	743	643	711	729	
	CACEROLERO 1 CAJON FRENO		REF.	ANCHO	100	150	200	201	300	400	401	500	502	503	600	601	602
	BCCCA	40		331	335	345	349	363	369	381	387	410	426	512	541	589	
	BCCCA	45		343	345	356	361	376	383	399	404	431	449	529	555	606	
	BCCCA	50		352	356	367	372	388	396	412	417	448	467	540	568	622	
	BCCCA	60		368	372	383	389	408	417	433	443	482	504	559	591	649	
	BCCCA	70		407	398	410	417	438	448	467	476	564	596	602	642	678	
	BCCCA	80		427	417	430	437	461	473	492	504	629	668	648	674	727	
	BCCCA	90		449	439	453	461	487	500	523	536	693	739	676	732	750	
	BCCCA	100		469	459	473	482	510	525	548	570	767	822	788	818	834	
	BCCCA	120		505	495	510	520	553	570	595	636	854	917	844	883	901	
	CACEROLERO FRENO CAJON INTERIOR		REF.	ANCHO	100	150	200	201	300	400	401	500	502	503	600	601	602
	BCCCIA	40		331	335	345	349	363	369	381	387	410	426	512	541	589	
	BCCCIA	45		343	345	356	361	376	383	399	404	431	449	529	555	606	
	BCCCIA	50		352	356	367	372	388	396	412	417	448	467	540	568	622	
	BCCCIA	60		368	372	383	389	408	417	433	443	482	504	559	591	649	
	BCCCIA	70		407	398	410	417	438	448	467	476	564	596	602	642	678	
	BCCCIA	80		427	417	430	437	461	473	492	504	629	668	648	674	727	
	BCCCIA	90		449	439	453	461	487	500	523	536	693	739	676	732	750	
	BCCCIA	100		469	459	473	482	510	525	548	570	767	822	788	818	834	
	BCCCIA	120		505	495	510	520	553	570	595	636	854	917	844	883	901	
	SEMI COL. HORNO MICRO CON CAJON ABAJO DE 122 DE ALTURA		REF.	ANCHO	ALTO	100	150	200	201	300	400	401	500	502	503	600	601
	1 CAJON METALICO																
	CHMCM 60	122		199	198	204	206	213	217	223	224	240	248	292	310	334	
1 CAJON FRENO																	
CHMCA 60	122		236	235	242	244	251	254	260	262	278	286	329	347	372		
SEMI COL. HORNO MICRO CON CACER. ABAJO DE 135 DE ALTURA		REF.	ANCHO	ALTO	100	150	200	201	300	400	401	500	502	503	600	601	602
	1 CACEROLERO METALICO																
	CHMCCM 60	135		241	239	247	249	258	263	270	271	290	300	353	375	404	
1 CACEROLERO FRENO																	
CHMCCA 60	135		286	284	293	295	304	307	315	317	336	346	398	420	450		
SEMI COL. HORNO CON PUERTAS ABAJO		REF.	ANCHO	ALTO	100	150	200	201	300	400	401	500	502	503	600	601	602
	1 PUERTA																
	CH 60	122 1P		172	174	179	183	198	206	214	234	248	262	276	300	340	
	REF.	ANCHO	ALTO	100	150	200	201	300	400	401	500	502	503	600	601	602	
2 PUERTAS																	
CH 60	122		181	186	192	197	213	222	234	245	278	300	342	368	419		
HORNO SOBREENCIMERA CON PUERTAS ARRIBA		REF.	ANCHO	ALTO	100	150	200	201	300	400	401	500	502	503	600	601	602
	1 PUERTA																
	CSH	60	127 1P	181	182	188	192	208	216	225	246	260	275	290	315	357	
	CSH	60	147 1P	217	219	226	231	249	260	270	295	312	330	348	378	428	
	REF.	ANCHO	ALTO	100	150	200	201	300	400	401	500	502	503	600	601	602	
	2 PUERTAS																
	CSH	60	127	190	196	202	207	224	233	246	257	292	315	359	386	440	
CSH	60	147	228	235	242	248	268	280	295	309	350	378	431	464	528		

COLUMNAS		TARIFA															
HORNO MICRO		EN CASO DE SER SOLO HORNO DEBE DE ESPECIFICARSE															
 <p>1 PUERTA</p>		UNA PUERTA ABAJO + UNA PUERTA ARRIBA															
		REF.	ANCHO	ALTO	100	150	200	201	300	400	401	500	502	503	600	601	602
		CHM	60	200 1P	258	263	271	279	308	326	341	382	409	437	451	498	579
 <p>2 PUERTAS</p>		DOS PUERTAS ABAJO + DOS PUERTAS ARRIBA															
		REF.	ANCHO	ALTO	100	150	200	201	300	400	401	500	502	503	600	601	602
		CHM	60	220 1P	283	295	304	314	348	365	390	418	451	483	486	542	636
HORNO MICRO 3 CAJONES		TARIFA															
 <p>1 PUERTA</p>		3 CAJONES METALICOS + UNA PUERTA ARRIBA															
		REF.	ANCHO	ALTO	100	150	200	201	300	400	401	500	502	503	600	601	602
		CHMCM	60	200 1P	357	368	379	388	421	437	461	472	536	571	608	637	723
 <p>2 PUERTAS</p>		3 CAJONES FRENO + UNA PUERTA ARRIBA															
		REF.	ANCHO	ALTO	100	150	200	201	300	400	401	500	502	503	600	601	602
		CHMCA	60	200 1P	485	492	507	518	554	573	597	616	686	724	748	785	885
 <p>1 PUERTA</p>		3 CAJONES METALICOS + DOS PUERTAS ARRIBA															
		REF.	ANCHO	ALTO	100	150	200	201	300	400	401	500	502	503	600	601	602
		CHMCM	60	200	374	387	399	410	444	461	479	491	578	617	683	713	810
 <p>2 PUERTAS</p>		3 CAJONES FRENO + DOS PUERTAS ARRIBA															
		REF.	ANCHO	ALTO	100	150	200	201	300	400	401	500	502	503	600	601	602
		CHMCA	60	200	497	506	522	532	567	584	612	614	701	739	805	836	933
 <p>1 PUERTA</p>		3 CAJONES METALICOS + DOS PUERTAS ARRIBA															
		REF.	ANCHO	ALTO	100	150	200	201	300	400	401	500	502	503	600	601	602
		CHMCM	60	200	374	387	399	410	444	461	479	491	578	617	683	713	810
 <p>2 PUERTAS</p>		3 CAJONES FRENO + DOS PUERTAS ARRIBA															
		REF.	ANCHO	ALTO	100	150	200	201	300	400	401	500	502	503	600	601	602
		CHMCA	60	220	512	523	539	550	586	603	633	636	754	799	845	885	993
HORNOS MICRO 2 CACEROLEROS METALICO		TARIFA															
 <p>1 PUERTA</p>		2 CACEROLEROS METALICOS + UNA PUERTA ARRIBA															
		REF.	ANCHO	ALTO	100	150	200	201	300	400	401	500	502	503	600	601	602
		CHMCCM	60	200 1P	356	360	371	379	403	416	433	447	488	514	600	627	749
 <p>2 PUERTAS</p>		2 CACEROLEROS FRENO + UNA PUERTA ARRIBA															
		REF.	ANCHO	ALTO	100	150	200	201	300	400	401	500	502	503	600	601	602
		CHMCCA	60	200 1P	431	434	447	454	478	491	508	522	563	589	675	703	824
 <p>1 PUERTA</p>		2 CACEROLEROS METALICOS + DOS PUERTAS ARRIBA															
		REF.	ANCHO	ALTO	100	150	200	201	300	400	401	500	502	503	600	601	602
		CHMCCM	60	200	372	379	391	399	425	438	458	466	497	523	682	689	846
 <p>2 PUERTAS</p>		2 CACEROLEROS FRENO + DOS PUERTAS ARRIBA															
		REF.	ANCHO	ALTO	100	150	200	201	300	400	401	500	502	503	600	601	602
		CHMCCA	60	200	447	452	466	474	500	513	534	541	572	598	757	765	921
 <p>1 PUERTA</p>		2 CACEROLEROS METALICOS + DOS PUERTAS ARRIBA															
		REF.	ANCHO	ALTO	100	150	200	201	300	400	401	500	502	503	600	601	602
		CHMCCM	60	220	389	398	410	419	451	466	490	504	572	607	706	744	867
 <p>2 PUERTAS</p>		2 CACEROLEROS FRENO + DOS PUERTAS ARRIBA															
		REF.	ANCHO	ALTO	100	150	200	201	300	400	401	500	502	503	600	601	602
		CHMCCA	60	220	464	470	485	495	526	541	565	580	647	682	781	819	943

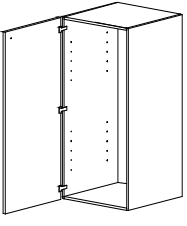
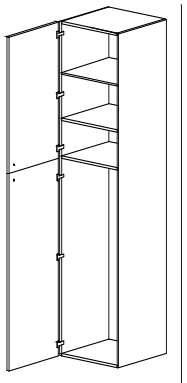
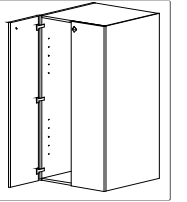
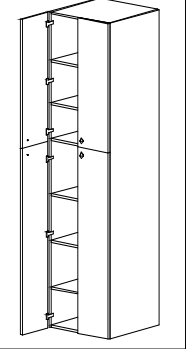
COLUMNAS															
ESCOBEROS															
TARIFA															
REF.	ANCHO	ALTO	100	150	200	201	300	400	401	500	502	503	600	601	602
															
1 PUERTA															
CL	25	122	140	144	148	152	160	167	177	190	268	285	265	274	309
CL	30		144	148	153	157	167	175	186	203	265	286	267	276	311
CL	35		148	151	156	161	174	183	194	217	275	298	272	284	328
CL	40		156	160	165	170	185	196	207	234	289	312	288	295	344
CL	45		161	164	169	175	192	205	217	248	298	322	298	303	366
CL	50		168	171	176	183	203	216	228	264	309	335	312	318	386
CL	60	1P	176	178	184	192	216	233	237	292	327	354	334	349	420
															
2 PUERTAS															
REF.	ANCHO	ALTO	100	150	200	201	300	400	401	500	502	503	600	601	602
CL	25	200	198	204	210	216	232	242	259	275	372	403	401	423	483
CL	30		204	210	217	224	243	255	272	295	375	406	405	427	487
CL	35		210	217	224	231	254	268	286	316	388	421	414	440	513
CL	40		220	227	234	243	268	285	303	340	405	439	433	455	537
CL	45		227	234	241	250	279	298	317	361	422	457	449	468	568
CL	50		236	244	252	261	294	315	334	386	441	479	468	490	597
CL	60	1P	250	257	265	277	316	341	353	428	476	518	501	539	650
REF.	ANCHO	ALTO	100	150	200	201	300	400	401	500	502	503	600	601	602
CL	25	220	210	216	223	230	247	259	276	293	402	435	425	451	517
CL	30		217	224	231	239	259	273	295	315	405	439	430	456	522
CL	35		224	232	239	247	271	287	306	339	422	457	439	470	551
CL	40		235	243	250	259	287	305	324	365	442	479	460	487	579
CL	45		242	249	257	267	299	320	340	388	462	502	478	501	614
CL	50		253	261	269	280	315	338	358	415	486	528	498	526	646
CL	60	1P	268	275	284	297	339	367	379	462	516	562	534	582	706
															
2 PUERTAS															
TARIFA															
REF.	ANCHO	ALTO	100	150	200	201	300	400	401	500	502	503	600	601	602
CL	60	122	191	202	208	217	237	253	274	309	434	476	427	444	514
CL	70		199	210	216	226	251	270	292	337	454	499	437	460	548
CL	80		213	224	231	241	271	293	315	370	478	525	465	480	577
CL	90		223	233	240	252	287	311	335	398	497	546	488	497	623
CL	100		239	248	256	269	308	335	360	432	522	573	516	528	664
															
4 PUERTAS															
REF.	ANCHO	ALTO	100	150	200	201	300	400	401	500	502	503	600	601	602
CL	60	200	278	297	306	319	356	381	415	461	621	682	663	706	827
CL	70		292	309	319	334	378	407	442	503	648	712	681	733	879
CL	80		314	332	342	359	410	443	479	553	684	751	722	765	930
CL	90		328	345	356	374	433	470	508	596	718	789	755	792	993
CL	100		347	366	377	397	462	503	542	645	756	832	792	836	1050
REF.	ANCHO	ALTO	100	150	200	201	300	400	401	500	502	503	600	601	602
CL	60	220	297	317	327	342	383	410	453	495	675	742	705	756	888
CL	70		312	332	342	358	407	439	476	542	708	779	724	785	947
CL	80		336	356	367	385	441	477	515	597	751	825	768	821	1005
CL	90		352	371	382	402	466	507	547	644	792	872	804	850	1075
CL	100		374	393	405	427	497	543	584	696	839	924	844	900	1140
FRIGO INTEGRABLE															
TARIFA															
REF.	ANCHO	ALTO	100	150	200	201	300	400	401	500	502	503	600	601	602
CFI	60	200 1P	280	288	297	310	354	382	395	479	533	580	561	604	728
CFI	60	220 1P	300	309	318	333	380	411	424	517	578	629	598	652	791
1 PUERTA															

ENCIMERAS Y MOSTRADORES DE 3CM

DISEÑO

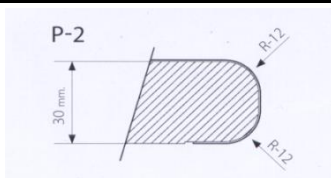

GRUESO 30 mm

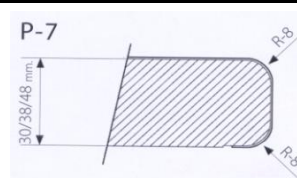

GRUESO 30 mm

REFERENCIA	PERFIL	GRUPO DE PRECIOS	ENCIMERA 63		MOSTRADOR 65		MOSTRADOR 90	
			TIRA 180	TIRA 360	TIRA 360	TIRA 360		
REFERENCIA	PERFIL	GRUPO DE PRECIOS	G1E2	G1E1	G1M651	G1M901		
RGA-9620-BR RGR-9640-BR	2	1	67	119	203	243		
8001-TF OAS-278-STONE TOR-264-STONE TRA-260-STONE 1907-MATE IH8-118-SOFT L-190-SOFT	7							
REFERENCIA	PERFIL	GRUPO DE PRECIOS	G2E2	G2E1	G2M651	G2M901		
PP-5564-BR	2	2	76	133	232	281		
GLP-283-SLATE DAV-442-SOFT OXA-445-WAX OXM-444-WAX GLR-244 GLG-400-TF	7							
REFERENCIA	PERFIL	GRUPO DE PRECIOS	G3E2	G3E1	G3M651	G3M901		
PP-5568-BR	2	3	84	147	279	349		
REFERENCIA	PERFIL	GRUPO DE PRECIOS	G4E2	G4E1	G4M651	G4M901		
QUARZ- LIMA QUARZ- BLANCO QUARZ- NEGRO QUARZ- NARANJA	2	4	96	174	287	355		

LAS COCINAS QUE LLEVEN INCORPORADOS MOSTRADORES TENDRAN UN PLAZO DE ENTREGA DE 45 DIAS

 JUNTA TERMINACION	JT	ALUMINIO BLANCO NEGRO	8
 JUNTA UNIÓN	JU	ALUMINIO BLANCO NEGRO	8
 JUNTA EMPALME	JE	ALUMINIO BLANCO NEGRO	8

ENCIMERAS Y MOSTRADORES DE 4CM

DISEÑO

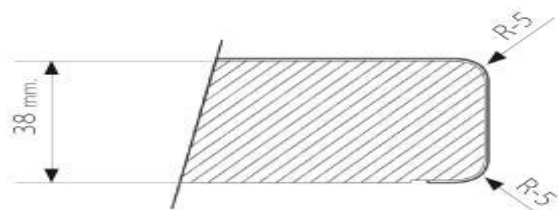

GRUESO 40 mm



GRUESO 40 mm

REFERENCIA	PERFIL	GRUPO DE PRECIOS	ENCIMERA 63	TIRA	MOSTRADOR 65	TIRA	MOSTRADOR 90	TIRA
				360		360		360
				G6E1		G6M651		G6M901
CAT-178 (STOCK) 3091 PIETRA (STOCK) CEA-233 (STOCK) CEM-234 (STOCK)	1	6	166		233		282	
				G7E1		G7M651		G7M901
PIT-780 LAR-770 CWT-772	1	7	178		248		300	
				G8E1		G8M651		G8M901
DAV-442 OXM-444 OXA-445 KMM-740 (STOCK) TRC-443 (STOCK) GLP-283 (STOCK) GLM-246 (STOCK) GLH-405 (STOCK) IPB-775 (STOCK) VEC-773 (STOCK) VEO-774 (STOCK)	1	8	194		268		325	

LAS COCINAS QUE LLEVEN INCORPORADOS MOSTRADORES TENDRAN UN PLAZO DE ENTREGA DE 45 DIAS

 <small>JUNTA TERMINACION 4 CM</small>	JT4	ALUMINIO	8
 <small>JUNTA UNION 4 CM</small>	JU4	ALUMINIO	8
 <small>JUNTA EMPALME 4 CM</small>	JE4	ALUMINIO	8

ENCIMERAS HIDROFUGAS DE 4CM

DISEÑO

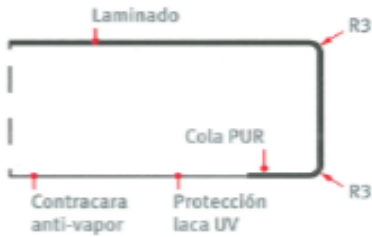

GRUESO 40 mm

ENCIMERA 63				ENCIMERA 63				
REFERENCIA	PERFIL	GRUPO	PUNTOS	REFERENCIA	PERFIL	GRUPO	PUNTOS	
		PRECIOS	410 CM			PRECIOS	410 CM	
		CODIGO	G10E1			CODIGO	G11E1	
H3332-ST10	ROBLE NEBRASKA	10	204	F310-ST87	CERAMIC HERRUMBROS	RECTO	234	
H1145-ST10	ROBLE BARDOLINO			F311-ST87	CERAMIC ANTRACITA			RECTO
F633-ST15	METALLO BRONCE			W100-ST89	BLANCO PREMIUM			RECTO
W980-ST2	BLANCO CAOLIN			U999-ST89	NEGRO			RECTO
F870-ST10	PIZARRA DE CASTILLA			U702-ST89	CACHEMIR			RECTO
H1334-ST9	ROBLE DE FERRARA			DISEÑOS PORO SINCRONIZADO				
F274-ST9	HORMIGON CLARO			H1180-ST37	R.HALIFAX NATURAL	RECTO	12	602
F275-ST9	HORMIGON OSCURO			H1181-ST37	R.HALIFAX TABACO	RECTO		
		H3309-ST28	R.GLADSTONE ARENA	RECTO				
		H3325-ST28	R.GLADSTONE TABACO	RECTO				
						GRUPO	PUNTOS	
						PRECIOS	410 CM	
						CODIGO	G12E1	

DISEÑO	REFERENCIA	COLOR	PUNTOS	
CORNISAS	REFERENCIA	DESCRIPCIÓN	PUNTOS	
			TIRA -180	TIRA -360
	CP1 CP2	CORNISA POSFORMADA EXTRACTIF. CORNISA POSFORMADA EXTRACTIF.	34	62
	CPL1	CORNISA / PORTALUZ POLILAMINADO		72
	CB1	CORNISA/PORTALUZ CHAPA BARNIZADA		72
	CBF1 CPLF1	CORNISA FORMA CHAPA BARNIZADA CORNISA POLILAMINADO FORMA		72 92
	PBF1 PPLF1	PORTALUZ BARNIZADO FORMA PORTALUZ POLILAMINADO FORMA		58 67



COPETES	REFERENCIA	COLOR	PUNTOS	
			TIRA -200	TIRA -400
	C1	ALUMINIO		40
	C2	NEGRO BLANCO	22	
COPETE MINI			TIRA -200	TIRA -400
	CM1	ALUMINIO		40
	CM2	NEGRO BLANCO	22	
	TERMINAL	ALUMINIO	SIN CARGO CON LA COMPRA DEL COPETE	
	ESQUINA	NEGRO		
	RINCON	BLANCO		
ZOCALO PVC ALUMINIO			TIRA -200	TIRA -400
	ZPA1	ZOCALO PVC CON LAMINA		44
	ZPA2	ALUMINIO 15 cm. DE ALTURA	27	
	RZPA	ALUMINIO	9	

ZOCALO ALUMINIO	REFERENCIA	COLOR	TIRA -200	TIRA -400
	ZA1	ALUMINIO		82
	ZA2		47	
	RZA	ALUMINIO	6	
	EZA	ALUMINIO	6	

ZOCALO	REFERENCIA	DESCRIPCION	1/2 TIRA	TIRA
	ZM2	MOD:RHIN-SUIZA-FLORIDA-PARIS ALABAMA-TORONTO-CANADA	18	
	ZM1	MOD:RHIN-SUIZA-FLORIDA-PARIS ALABAMA-TORONTO-CANADA		30
	ZP2	MOD: MIÑO-LUXEMBURGO	24	
	ZP1	MOD: MIÑO-LUXEMBURGO		48
	ZPL1	MOD:POLILAMINADOS		54
	ZL1	MOD:LACADOS		64
	ZB1	MOD:MADERA		54

PERFIL ZOCALO	REFERENCIA	COLOR	TIRA -180	TIRA -360
	PZ1 PZ2	TRANSPARENTE	5	9

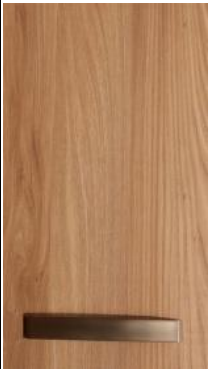

PUERTAS

DISENO		TARIFA															
PUERTAS		REF.	ANCHO	ALTO	100	150	200	201	300	400	401	500	502	503	600	601	602
	P	25	42	24	24	25	36	35	39	46	51		0	0	63	71	89
	P	30		26	26	27	38	38	43	51	56		0	0	63	71	89
	P	35		28	29	30	41	41	47	55	60		0	0	65	77	99
	P	40		29	29	30	43	45	52	60	66		0	0	68	82	102
	P	45		30	31	31	44	48	55	64	70		0	0	72	87	110
	P	50		32	33	34	47	51	60	69	76		0	0	75	93	114
	P	60		35	36	37	51	57	67	76	84		0	0	81	104	127
	P	25	70	28	28	29	42	41	46	54	60		0	0	74	84	105
	P	30		30	30	31	45	45	51	60	66		0	0	74	84	105
	P	35		33	34	35	48	48	56	64	71		0	0	77	90	116
	P	40		34	34	35	50	53	61	70	77		0	0	81	97	120
	P	45		36	36	37	52	56	65	75	82		0	0	84	103	129
	P	50		38	38	40	56	60	70	81	89		0	0	88	109	134
	P	60		42	42	43	60	67	79	90	99		0	0	96	122	149
	P	25	90	33	33	34	49	49	56	65	72		0	0	86	101	132
	P	30		36	36	37	58	54	62	77	85		0	0	86	101	132
	P	35		38	38	39	55	58	68	78	86		0	0	89	111	140
	P	40		40	41	42	59	64	74	85	93		0	0	94	120	146
	P	45		42	43	44	62	68	80	91	100		0	0	99	130	153
	P	50		45	46	47	65	73	86	98	107		0	0	104	139	158
	P	60		49	49	51	69	81	97	109	120		0	0	113	157	172
	P	25	127	46	47	48	69	69	78	91	100		0	0	121	142	185
	P	30		50	51	52	82	76	87	108	119		0	0	121	142	185
	P	35		53	54	55	78	82	95	109	120		0	0	124	155	196
	P	40		57	57	59	82	89	104	118	130		0	0	131	168	205
	P	45		59	60	62	86	95	111	128	140		0	0	138	182	214
	P	50		63	64	66	91	102	120	137	150		0	0	145	195	221
	P	60		68	69	71	97	114	136	152	168		0	0	159	220	241
	P	25	147	49	50	52	74	74	83	98	108		0	0	130	152	198
	P	30		54	54	56	87	81	93	116	128		0	0	130	152	198
P	35		57	57	59	83	88	101	117	129		0	0	133	166	210	
P	40		61	61	63	88	95	111	127	140		0	0	141	180	219	
P	45		64	64	66	92	102	119	137	150		0	0	148	195	230	
P	50		68	68	71	97	109	129	146	161		0	0	155	209	237	
P	60		73	74	76	104	122	146	163	180		0	0	170	235	258	
DISENO																	
FRENTE CAJON		F	25	17,5	11	11	12	13	20	22	25	28	27	31	34	37	41
	F	30		11	11	12	13	20	22	25	28	30	35	34	37	41	
	F	35		11	11	12	13	20	22	25	28	33	38	35	38	42	
	F	40		12	12	13	14	22	24	27	30	36	41	36	39	43	
	F	45		12	12	13	14	22	24	27	30	40	46	36	39	43	
	F	50		15	15	16	18	28	31	35	39	43	49	38	41	45	
	F	60		15	15	16	18	28	31	35	39	46	53	38	41	45	
PANEL FRIGO LISO	PFL				68	68	70	70	68	72	72	74	74	78	76	76	84
PANEL FRIGO FORMA	PFF												246	276	292	319	351
PANEL LAVAV. LISO	PLL				34	34	35	35	34	36	36	37	37	39	38	38	42
PANEL LAVAV. FORMA	PLF												139	156	144	163	179

PUERTAS DE COSTADO , GALERIAS DOBLE GROSOR,REGLETAS Y ENTREPAÑOS																			
DISEÑO			TARIFA																
PUERTAS DE COSTADO LISAS	REF.	ANCHO	ALTO	100	150	200	201	300	400	401	500	501	502	503	600	601	602		
	PCL	35	11	11	12	12	13	14	15	20	31		35	40	25	25	25		
	PCL	35	20		13	15	15	16	19	22	28	31		36	48	30	30	30	
	PCL	35	35		14	16	16	17	21	24	30	31		37	51	42	42	42	
	PCL	35	45		15	16	17	18	24	27	33	31		39	53	42	42	42	
	PCL	35	70		19	20	21	23	31	36	43	40		49	58	50	50	50	
	PCL	35	90		21	23	24	27	37	43	52	49		61	71	62	62	62	
	PCL	35	127		26	28	29	34	48	57	63	62		79	81	84	84	84	
	PCL	35	216		36	40	41	48	72	88	100	97		140	162	126	126	126	
	PCL	35	236		38	42	43	52	78	92	109	130		150	173	141	141	141	
	COSTADO VISTO FONDO - 35	PCL	60	70	23	25	26	30	43	52	61	62		79	91	85	85	85	
		PCL	60	90	27	29	30	36	52	64	74	97		111	131	95	95	95	
PCL		60	122	35	39	40	47	70	86	98	106		140	162	179	179	179		
PCL		60	216	51	57	59	71	110	137	152	176		209	241	187	187	187		
PCL		60	236	56	63	65	77	120	149	165	203		226	268	194	194	194		
GALERIAS DOBLE GROSOR	GDG	35	70	42	45	46	51								80	80	80		
	GDG	35	90	46	51	53	59								99	99	99		
	GDG	35	127	57	62	64	75								134	134	134		
	GDG	35	216	79	87	90	106								202	202	202		
	GDG	35	236	84	92	95	114								226	226	226		
	GDG	60	70	51	55	57	66								136	136	136		
	GDG	60	90	59	64	66	79								152	152	152		
	GDG	60	127	77	85	88	103								286	286	286		
	GDG	60	216	112	126	130	156								299	299	299		
GDG	60	236	123	139	143	169								310	310	310			
REGLETAS	R	5	70	6	9	9	10	14	15	18	14		23	30	24	24	24		
	R		90	7	11	11	12	16	18	22	16		25	32	28	28	28		
	R		127	9	12	13	14	20	22	28	23		37	42	37	37	37		
	R		216	16	17	18	21	28	31	40	38		60	71	51	51	51		
	R		236	19	21	22	23	31	35	44	42		68	80	56	56	56		
	R	10	70	8	11	11	13	17	19	23	17		29	38	30	30	30		
	R		90	9	14	14	15	20	22	28	20		31	40	35	35	35		
	R		127	11	16	16	18	25	27	35	29		46	53	46	46	46		
	R		216	20	21	22	26	35	39	50	47		75	89	64	64	64		
	R		236	24	26	27	29	39	44	55	52		85	100	70	70	70		
ENTREPAÑOS ALTOS INTERIORES	BLANCOS			DISEÑO								CRISTAL							
	EAB	30	5	EAC								30	6	EACR				30	6
		35	6									35	7					35	7
		40	7									40	8					40	8
		45	9									45	10					45	10
		50	10									50	11					50	11
		60	12									60	13					60	13
		70	14									70	15					70	15
		80	16									80	17					80	17
		90	18									90	19					90	19
		100	20									100	21					100	21
	BLANCOS			DISEÑO								CRISTAL							
	EBB	30	6	EBC								30	7	EBCR				30	7
		35	8									35	9					35	9
		40	9									40	10					40	10
		45	10									45	11					45	11
		50	12									50	13					50	13
		60	14									60	15					60	15
		70	16									70	17					70	17
	80	19									80	20					80	20	
	90	22									90	24					90	24	
	100	25									100	27					100	27	

REFER.	DESCRIPCION	ACABADO	MEDIDA	PAGINA	PUNTOS	REFER.	DESCRIPCION	ACABADO	MEDIDA	PAGINA	PUNTOS
1063	ASA GLOBO	CROMO - BRILLO	128	T-1	4	3631/15	TIR.CANTO PUERTA	INOX LOOK	150	T-4	8
1065	ASA GLOBO	CROMO - MATE	128	T-1	5	3631/20	TIR.CANTO PUERTA	INOX LOOK	200	T-4	10
2020	ASA	NIQUEL-MATE	128	T-1	6	3631/25	TIR.CANTO PUERTA	INOX LOOK	250	T-4	12
2021	ASA	CROMO	128	T-1	5	3631/30	TIR.CANTO PUERTA	INOX LOOK	300	T-4	14
3003	ASA BARRA	INOX	160	T-1	6	3631/35	TIR.CANTO PUERTA	INOX LOOK	350	T-4	15
3004	POMO	CROMO-MATE	13	T-1	6	3631/40	TIR.CANTO PUERTA	INOX LOOK	400	T-4	17
3515	ASA	CROMO-MATE	192	T-1	11	3631/45	TIR.CANTO PUERTA	INOX LOOK	450	T-4	19
3522	ASA	NIQUEL-MATE	160	T-1	11	3631/50	TIR.CANTO PUERTA	INOX LOOK	500	T-4	21
3530	ASA BARRA	INOX	96	T-1	14	3631/60	TIR.CANTO PUERTA	INOX LOOK	600	T-4	25
3531	ASA BARRA	INOX	128	T-1	15	3631/70	TIR.CANTO PUERTA	INOX LOOK	700	T-4	29
3532	ASA BARRA	INOX	160	T-1	15	3631/80	TIR.CANTO PUERTA	INOX LOOK	800	T-4	33
3533	ASA BARRA	INOX	192	T-1	16	3631/90	TIR.CANTO PUERTA	INOX LOOK	900	T-4	37
3534	ASA BARRA	INOX	242	T-1	18	3631/100	TIR.CANTO PUERTA	INOX LOOK	1000	T-4	41
3535	ASA BARRA	INOX	292	T-1	19	3631/120	TIR.CANTO PUERTA	INOX LOOK	1200	T-4	51
3536	ASA BARRA	INOX	342	T-1	21	3632	ASA	CROMO MATE	128	T-4	10
3537	ASA BARRA	INOX	392	T-1	22	3633	ASA	CROMO MATE	192	T-4	14
3538	ASA BARRA	INOX	492	T-1	25	3634	ASA	CROMO MATE	64	T-4	8
3539	ASA BARRA	INOX	592	T-1	27	3635	ASA	CROMO MATE	128	T-5	8
3540	ASA BARRA	INOX	692	T-1	31	3636	ASA	CROMO MATE	128	T-5	9
3541	ASA BARRA	INOX	792	T-1	35	3637	ASA	CROMO MATE	160	T-5	9
3542	ASA BARRA	INOX	992	T-1	44	3638	ASA	CROMO MATE	160	T-5	8
3555	ASA	ANODIZADO M.	128	T-1	6	3639	ASA	CROMO MATE	128	T-5	8
3558	ASA	ANODIZADO M.	160	T-1	9						
3564	POMO	NIQUEL BISÚ	34	T-1	4						
3568	ASA	CR. SATINADO	240	T-1	7						
3570	ASA	CROMO MATE	160	T-2	6						
3574	ASA CONCHA	INOX	96	T-2	7						
3584	ASA	NIQUEL SAT.	160	T-2	16						
3585	ASA	NIQUEL SAT.	320	T-2	22	TU15	TIR.UÑERO	ALUMINIO	150	T-5	11
3587	ASA	CROMO MATE	160	T-2	5	TU20	TIR.UÑERO	ALUMINIO	200	T-5	11
3590	ASA	NIQUEL SAT.	192	T-2	7	TU25	TIR.UÑERO	ALUMINIO	250	T-5	12
3593	TIRADOR	CROMO BRILLO	64	T-2	7	TU30	TIR.UÑERO	ALUMINIO	300	T-5	12
3594	ASA	NIQUEL SAT.	160	T-2	11	TU35	TIR.UÑERO	ALUMINIO	350	T-5	14
3599	ASA	CROMO BRILLO	320	T-2	12	TU40	TIR.UÑERO	ALUMINIO	400	T-5	14
3600	ASA	CROMO BRILLO	192	T-2	9	TU45	TIR.UÑERO	ALUMINIO	450	T-5	15
3601	ASA	NIQUEL-SAT.	160	T-2	11	TU50	TIR.UÑERO	ALUMINIO	500	T-5	16
3604	ASA	CROMO MATE	160	T-2	3	TU60	TIR.UÑERO	ALUMINIO	600	T-5	18
3605	ASA	CROMO MATE	128	T-2	5	TU70	TIR.UÑERO	ALUMINIO	700	T-5	22
3606	ASA	CROMO MATE	160	T-2	5	TU80	TIR.UÑERO	ALUMINIO	800	T-5	24
3607	ASA	NIQUEL SAT.	128	T-3	4	TU90	TIR.UÑERO	ALUMINIO	900	T-5	26
3608	ASA	NIQUEL SAT.	224	T-3	6	TU100	TIR.UÑERO	ALUMINIO	1000	T-5	27
3609	ASA	NIQUEL SAT.	192	T-3	18						
3610	ASA	NIQUEL SAT.	320	T-3	25	TEG15	T. EFECTO GOLA	ALUMINIO	150	T-5	9
3611	ASA	CROMO MATE	160	T-3	16	TEG20	T. EFECTO GOLA	ALUMINIO	200	T-5	10
3616	TIRADOR	EMBUTIDO	128	T-3	6	TEG25	T. EFECTO GOLA	ALUMINIO	250	T-5	10
3617	TIRADOR	CROMO MATE	160	T-3	4	TEG30	T. EFECTO GOLA	ALUMINIO	300	T-5	11
3618	TIRADOR	CROMO BRILLO	128	T-3	3	TEG35	T. EFECTO GOLA	ALUMINIO	350	T-5	12
3619	TIRADOR	CROMO MATE	160	T-3	4	TEG40	T. EFECTO GOLA	ALUMINIO	400	T-5	13
3620	TIRADOR	CROMO MATE	160	T-3	4	TEG45	T. EFECTO GOLA	ALUMINIO	450	T-5	15
3621	ASA	NIQUEL SAT,	320	T-3	11	TEG50	T. EFECTO GOLA	ALUMINIO	500	T-5	16
3622	ASA	NIQUEL SAT,	166	T-3	7	TEG60	T. EFECTO GOLA	ALUMINIO	600	T-5	18
3623	TIRADOR	INOX LOOK	160	T-3	13	TEG70	T. EFECTO GOLA	ALUMINIO	700	T-5	21
3624	TIRADOR	INOX LOOK	32	T-3	9	TEG80	T. EFECTO GOLA	ALUMINIO	800	T-5	23
3625	TIRADOR	BLANCO	192	T-4	10	TEG90	T. EFECTO GOLA	ALUMINIO	900	T-5	26
3626	TIRADOR	BLANCO	32	T-4	5	TEG100	T. EFECTO GOLA	ALUMINIO	1000	T-5	29
3627	TIRADOR	NIQUEL CEPILL.	192	T-4	12	TEG120	T. EFECTO GOLA	ALUMINIO	1200	T-5	32
3628	TIRADOR	NIQUEL CEPILL.	32	T-4	6						
3629	ASA	NIQUEL SAT,	288	T-4	9						
3630	ASA	NIQUEL SAT,	160	T-4	5						

	CODIGO / REF.	1063 -1065		CODIGO / REF.	2020-2021
	MED. TALADRO	128 mm		MED. TALADRO	128 mm
	MED. TOTAL	152 mm		MED. TOTAL	165 mm
	COLOR	VARIOS		COLOR	VARIOS
	COLOR	VARIOS		COLOR	VARIOS

	CODIGO / REF.	3003		CODIGO / REF.	3004
	MED. TALADRO	160 mm		MED. TALADRO	
	MED. TOTAL	215 mm		MED. TOTAL	13 mm
	COLOR	ACERO INOX		COLOR	CROMO MATE
	COLOR	ACERO INOX		COLOR	CROMO MATE

	CODIGO / REF.	3515		CODIGO / REF.	3522
	MED. TALADRO	192 mm		MED. TALADRO	160 mm
	MED. TOTAL	225 mm		MED. TOTAL	170 mm
	COLOR	CROMO MATE		COLOR	NIQUEL MATE
	COLOR	CROMO MATE		COLOR	NIQUEL MATE

							
CODIGO / REF.	3530	3531	3532	3533	3534	3535	3536
MED. TALADRO	96 mm	128 mm	160 mm	192 mm	242 mm	292 mm	342 mm
MED. TOTAL	155 mm	192 mm	222 mm	256 mm	306 mm	356 mm	406 mm
COLOR	ACERO INOX						

							
CODIGO / REF.	3537	3538	3539	3540	3541	3542	
MED. TALADRO	392 mm	492 mm	592 mm	692 mm	792 mm	992 mm	
MED. TOTAL	456 mm	556 mm	656 mm	756 mm	856 mm	1056 mm	
COLOR	ACERO INOX						

	CODIGO / REF.	3555		CODIGO / REF.	3558
	MED. TALADRO	128 mm		MED. TALADRO	160 mm
	MED. TOTAL	134 mm		MED. TOTAL	170 mm
	COLOR	ANODIZA.MATE		COLOR	ANODIZA.MATE
	COLOR	ANODIZA.MATE		COLOR	ANODIZA.MATE

	CODIGO / REF.	3564		CODIGO / REF.	3568
	MED. TALADRO			MED. TALADRO	240 mm
	MED. TOTAL	34 mm		MED. TOTAL	271 mm
	COLOR	NIQUEL BISÚ		COLOR	CR. SATINADO
	COLOR	NIQUEL BISÚ		COLOR	CR. SATINADO

	<table border="1"> <tr><td>CODIGO / REF.</td></tr> <tr><td>3570</td></tr> <tr><td>MED. TALADRO</td></tr> <tr><td>160 mm</td></tr> <tr><td>MED. TOTAL</td></tr> <tr><td>200 mm</td></tr> <tr><td>COLOR</td></tr> <tr><td>CROMO MATE</td></tr> </table>	CODIGO / REF.	3570	MED. TALADRO	160 mm	MED. TOTAL	200 mm	COLOR	CROMO MATE		<table border="1"> <tr><td>CODIGO / REF.</td></tr> <tr><td>3574</td></tr> <tr><td>MED. TALADRO</td></tr> <tr><td>96 mm</td></tr> <tr><td>MED. TOTAL</td></tr> <tr><td>150 mm</td></tr> <tr><td>COLOR</td></tr> <tr><td>INOX</td></tr> </table>	CODIGO / REF.	3574	MED. TALADRO	96 mm	MED. TOTAL	150 mm	COLOR	INOX
CODIGO / REF.																			
3570																			
MED. TALADRO																			
160 mm																			
MED. TOTAL																			
200 mm																			
COLOR																			
CROMO MATE																			
CODIGO / REF.																			
3574																			
MED. TALADRO																			
96 mm																			
MED. TOTAL																			
150 mm																			
COLOR																			
INOX																			
	<table border="1"> <tr><td>CODIGO / REF.</td></tr> <tr><td>3584</td></tr> <tr><td>MED. TALADRO</td></tr> <tr><td>160 mm</td></tr> <tr><td>MED. TOTAL</td></tr> <tr><td>170 mm</td></tr> <tr><td>COLOR</td></tr> <tr><td>NIQ. SATINADO</td></tr> </table>	CODIGO / REF.	3584	MED. TALADRO	160 mm	MED. TOTAL	170 mm	COLOR	NIQ. SATINADO		<table border="1"> <tr><td>CODIGO / REF.</td></tr> <tr><td>3585</td></tr> <tr><td>MED. TALADRO</td></tr> <tr><td>320 mm</td></tr> <tr><td>MED. TOTAL</td></tr> <tr><td>330 mm</td></tr> <tr><td>COLOR</td></tr> <tr><td>NIQ. SATINADO</td></tr> </table>	CODIGO / REF.	3585	MED. TALADRO	320 mm	MED. TOTAL	330 mm	COLOR	NIQ. SATINADO
CODIGO / REF.																			
3584																			
MED. TALADRO																			
160 mm																			
MED. TOTAL																			
170 mm																			
COLOR																			
NIQ. SATINADO																			
CODIGO / REF.																			
3585																			
MED. TALADRO																			
320 mm																			
MED. TOTAL																			
330 mm																			
COLOR																			
NIQ. SATINADO																			
	<table border="1"> <tr><td>CODIGO / REF.</td></tr> <tr><td>3587</td></tr> <tr><td>MED. TALADRO</td></tr> <tr><td>160 mm</td></tr> <tr><td>MED. TOTAL</td></tr> <tr><td>166 mm</td></tr> <tr><td>COLOR</td></tr> <tr><td>CROMO MATE</td></tr> </table>	CODIGO / REF.	3587	MED. TALADRO	160 mm	MED. TOTAL	166 mm	COLOR	CROMO MATE		<table border="1"> <tr><td>CODIGO / REF.</td></tr> <tr><td>3590</td></tr> <tr><td>MED. TALADRO</td></tr> <tr><td>192 mm</td></tr> <tr><td>MED. TOTAL</td></tr> <tr><td>205 mm</td></tr> <tr><td>COLOR</td></tr> <tr><td>NIQ. SATINADO</td></tr> </table>	CODIGO / REF.	3590	MED. TALADRO	192 mm	MED. TOTAL	205 mm	COLOR	NIQ. SATINADO
CODIGO / REF.																			
3587																			
MED. TALADRO																			
160 mm																			
MED. TOTAL																			
166 mm																			
COLOR																			
CROMO MATE																			
CODIGO / REF.																			
3590																			
MED. TALADRO																			
192 mm																			
MED. TOTAL																			
205 mm																			
COLOR																			
NIQ. SATINADO																			
	<table border="1"> <tr><td>CODIGO / REF.</td></tr> <tr><td>3593</td></tr> <tr><td>MED. TALADRO</td></tr> <tr><td>64 mm</td></tr> <tr><td>MED. TOTAL</td></tr> <tr><td>75 mm</td></tr> <tr><td>COLOR</td></tr> <tr><td>CROMO BRILLO</td></tr> </table>	CODIGO / REF.	3593	MED. TALADRO	64 mm	MED. TOTAL	75 mm	COLOR	CROMO BRILLO		<table border="1"> <tr><td>CODIGO / REF.</td></tr> <tr><td>3594</td></tr> <tr><td>MED. TALADRO</td></tr> <tr><td>160 mm</td></tr> <tr><td>MED. TOTAL</td></tr> <tr><td>170 mm</td></tr> <tr><td>COLOR</td></tr> <tr><td>NIQ. SATINADO</td></tr> </table>	CODIGO / REF.	3594	MED. TALADRO	160 mm	MED. TOTAL	170 mm	COLOR	NIQ. SATINADO
CODIGO / REF.																			
3593																			
MED. TALADRO																			
64 mm																			
MED. TOTAL																			
75 mm																			
COLOR																			
CROMO BRILLO																			
CODIGO / REF.																			
3594																			
MED. TALADRO																			
160 mm																			
MED. TOTAL																			
170 mm																			
COLOR																			
NIQ. SATINADO																			
	<table border="1"> <tr><td>CODIGO / REF.</td></tr> <tr><td>3599</td></tr> <tr><td>MED. TALADRO</td></tr> <tr><td>320 mm</td></tr> <tr><td>MED. TOTAL</td></tr> <tr><td>380 mm</td></tr> <tr><td>COLOR</td></tr> <tr><td>CROMO BRILLO</td></tr> </table>	CODIGO / REF.	3599	MED. TALADRO	320 mm	MED. TOTAL	380 mm	COLOR	CROMO BRILLO	<table border="1"> <tr><td>CODIGO / REF.</td></tr> <tr><td>3600</td></tr> <tr><td>MED. TALADRO</td></tr> <tr><td>192 mm</td></tr> <tr><td>MED. TOTAL</td></tr> <tr><td>222 mm</td></tr> <tr><td>COLOR</td></tr> <tr><td>CROMO BRILLO</td></tr> </table>	CODIGO / REF.	3600	MED. TALADRO	192 mm	MED. TOTAL	222 mm	COLOR	CROMO BRILLO	
CODIGO / REF.																			
3599																			
MED. TALADRO																			
320 mm																			
MED. TOTAL																			
380 mm																			
COLOR																			
CROMO BRILLO																			
CODIGO / REF.																			
3600																			
MED. TALADRO																			
192 mm																			
MED. TOTAL																			
222 mm																			
COLOR																			
CROMO BRILLO																			
	<table border="1"> <tr><td>CODIGO / REF.</td></tr> <tr><td>3601</td></tr> <tr><td>MED. TALADRO</td></tr> <tr><td>160 mm</td></tr> <tr><td>MED. TOTAL</td></tr> <tr><td>172 mm</td></tr> <tr><td>COLOR</td></tr> <tr><td>NIQ. SATINADO</td></tr> </table>	CODIGO / REF.	3601	MED. TALADRO	160 mm	MED. TOTAL	172 mm	COLOR	NIQ. SATINADO		<table border="1"> <tr><td>CODIGO / REF.</td></tr> <tr><td>3604</td></tr> <tr><td>MED. TALADRO</td></tr> <tr><td>160 mm</td></tr> <tr><td>MED. TOTAL</td></tr> <tr><td>173 mm</td></tr> <tr><td>COLOR</td></tr> <tr><td>CROMO MATE</td></tr> </table>	CODIGO / REF.	3604	MED. TALADRO	160 mm	MED. TOTAL	173 mm	COLOR	CROMO MATE
CODIGO / REF.																			
3601																			
MED. TALADRO																			
160 mm																			
MED. TOTAL																			
172 mm																			
COLOR																			
NIQ. SATINADO																			
CODIGO / REF.																			
3604																			
MED. TALADRO																			
160 mm																			
MED. TOTAL																			
173 mm																			
COLOR																			
CROMO MATE																			
	<table border="1"> <tr><td>CODIGO / REF.</td></tr> <tr><td>3605</td></tr> <tr><td>MED. TALADRO</td></tr> <tr><td>128 mm</td></tr> <tr><td>MED. TOTAL</td></tr> <tr><td>196 mm</td></tr> <tr><td>COLOR</td></tr> <tr><td>CROMO MATE</td></tr> </table>	CODIGO / REF.	3605	MED. TALADRO	128 mm	MED. TOTAL	196 mm	COLOR	CROMO MATE		<table border="1"> <tr><td>CODIGO / REF.</td></tr> <tr><td>3606</td></tr> <tr><td>MED. TALADRO</td></tr> <tr><td>160 mm</td></tr> <tr><td>MED. TOTAL</td></tr> <tr><td>176 mm</td></tr> <tr><td>COLOR</td></tr> <tr><td>CROMO MATE</td></tr> </table>	CODIGO / REF.	3606	MED. TALADRO	160 mm	MED. TOTAL	176 mm	COLOR	CROMO MATE
CODIGO / REF.																			
3605																			
MED. TALADRO																			
128 mm																			
MED. TOTAL																			
196 mm																			
COLOR																			
CROMO MATE																			
CODIGO / REF.																			
3606																			
MED. TALADRO																			
160 mm																			
MED. TOTAL																			
176 mm																			
COLOR																			
CROMO MATE																			

	REFERENCIA	REFERENCIA
	3607	3608
	MED. TALADRO	MED. TALADRO
	128 mm	224 mm
	MED. TOTAL	MED. TOTAL
	139 mm	236 mm
COLOR	COLOR	
NIQ. SATINADO	NIQ. SATINADO	

	REFERENCIA	REFERENCIA
	3609	3610
	MED. TALADRO	MED. TALADRO
	192 mm	320 mm
	MED. TOTAL	MED. TOTAL
	220 mm	348 mm
COLOR	COLOR	
NIQ. SATINADO	NIQ. SATINADO	

	CODIGO / REF.	CODIGO / REF.
	3611	3616
	MED. TALADRO	MED. TALADRO
	160	120
	MED. TOTAL	MED. TOTAL
175	150	
COLOR	COLOR	
CROMO MATE	CROMO MATE	

	CODIGO / REF.	CODIGO / REF.
	3617	3618
	MED. TALADRO	MED. TALADRO
	160 mm	128 mm
	MED. TOTAL	MED. TOTAL
190 mm	160 mm	
COLOR	COLOR	
CROMO MATE	CROMO BRILLO	

	CODIGO / REF.	CODIGO / REF.
	3619	3620
	MED. TALADRO	MED. TALADRO
	160 mm	160
	MED. TOTAL	MED. TOTAL
190 mm		
COLOR	COLOR	
CROMO MATE		

	CODIGO / REF.	CODIGO / REF.
	3621	3622
	MED. TALADRO	MED. TALADRO
	320 mm	166 mm
	MED. TOTAL	MED. TOTAL
	358 mm	194 mm
COLOR	COLOR	
NIQUEL SATIN	NIQUEL SATIN	

	CODIGO / REF.	CODIGO / REF.
	3623	3624
	MED. TALADRO	MED. TALADRO
	160 mm	32 mm
	MED. TOTAL	MED. TOTAL
	290 mm	140 mm
COLOR	COLOR	
INOX LOOK	INOX LOOK	



CODIGO / REF.	CODIGO / REF.
3625	3626
MED. TALADRO	MED. TALADRO
192 mm	32 mm
MED. TOTAL	MED. TOTAL
312 mm	88 mm
COLOR	COLOR
BLANCO	BLANCO

CODIGO / REF.	CODIGO / REF.
3627	3628
MED. TALADRO	MED. TALADRO
192 mm	32 mm
MED. TOTAL	MED. TOTAL
312 mm	88 mm
COLOR	COLOR
NIQUEL CEPILL	NIQUEL CEPILL



CODIGO / REF.	CODIGO / REF.
3629	3630
MED. TALADRO	MED. TALADRO
288 mm	160 mm
MED. TOTAL	MED. TOTAL
309 mm	182 mm
COLOR	COLOR
NIQUEL SATIN	NIQUEL SATIN



INOX LOOK

CODIGO / REF.	3631/15	3631/20	3631/25	3631/30	3631/35	3631/40	3631/45
MEDIDA	150 mm	200 mm	250 mm	300 mm	350 mm	400 mm	450 mm
CODIGO / REF.	3631/50	3631/60	3631/70	3631/80	3631/90	3631/100	3631/120
MEDIDA	500 mm	600 mm	700 mm	800 mm	900 mm	1000 mm	1200 mm



CODIGO / REF.	CODIGO / REF.
3632	3633
MED. TALADRO	MED. TALADRO
128 mm	192 mm
MED. TOTAL	MED. TOTAL
148 mm	212 mm
COLOR	COLOR
INOX	INOX



CODIGO / REF.
3634
MED. TALADRO
64 mm
MED. TOTAL
79 mm
COLOR
INOX



CODIGO / REF.
3635
MED. TALADRO
128 mm
MED. TOTAL
133 mm
COLOR
INOX

	CODIGO / REF.	3636		CODIGO / REF.	3637
	MED. TALADRO	128 mm		MED. TALADRO	160 mm
	MED. TOTAL	191 mm		MED. TOTAL	185 mm
	COLOR	ALUM. MATE		COLOR	INOX
	ALUM. MATE			INOX	

	CODIGO / REF.	3638		CODIGO / REF.	3639
	MED. TALADRO	160 mm		MED. TALADRO	128 mm
	MED. TOTAL	204 mm		MED. TOTAL	196 mm
	COLOR	INOX		COLOR	NEGRO
	INOX			NEGRO	



CODIGO / REF.	TU15	TU20	TU25	TU30	TU35	TU40	TU45
MEDIDA	150 mm	200 mm	250 mm	300 mm	350 mm	400 mm	450 mm
CODIGO / REF.	TU50	TU60	TU70	TU80	TU90	TU100	
MEDIDA	500 mm	600 mm	700 mm	800 mm	900 mm	1000 mm	

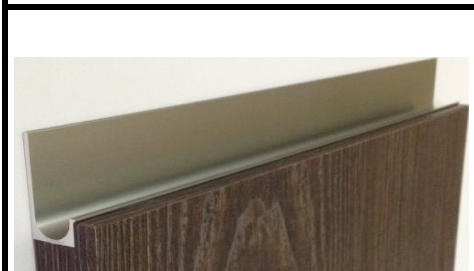

TIRADOR EFECTO GOLA ALUMINIO				
REFERENCIA	TEG15	TEG20	TEG25	TEG30
MEDIDA	150 mm	200 mm	250 mm	300 mm
REFERENCIA	TEG35	TEG40	TEG45	TEG50
MEDIDA	350 mm	400 mm	450 mm	500 mm
REFERENCIA	TEG60	TEG70	TEG80	TEG90
MEDIDA	600 mm	700 mm	800 mm	900 mm
REFERENCIA	TEG100	TEG120		
MEDIDA	1000 mm	1200 mm		



TIRADOR EFECTO GOLA NEGRO				
REFERENCIA	TEGN15	TEGN20	TEGN25	TEGN30
MEDIDA	150 mm	200 mm	250 mm	300 mm
REFERENCIA	TEGN35	TEGN40	TEGN45	TEGN50
MEDIDA	350 mm	400 mm	450 mm	500 mm
REFERENCIA	TEGN60	TEGN70	TEGN80	TEGN90
MEDIDA	600 mm	700 mm	800 mm	900 mm
REFERENCIA	TEGN100	TEGN120		
MEDIDA	1000 mm	1200 mm		



TIRADOR EFECTO GOLA BLANCO				
REFERENCIA	TEGB15	TEGB20	TEGB25	TEGB30
MEDIDA	150 mm	200 mm	250 mm	300 mm
REFERENCIA	TEGB35	TEGB40	TEGB45	TEGB50
MEDIDA	350 mm	400 mm	450 mm	500 mm
REFERENCIA	TEGB60	TEGB70	TEGB80	TEGB90
MEDIDA	600 mm	700 mm	800 mm	900 mm
REFERENCIA	TEGB100	TEGB120		
MEDIDA	1000 mm	1200 mm		

DISEÑO	REFERENCIA	DESCRIPCIÓN	ACABADO	PUNTOS
	CUBMF30	CUBERTERO 30	TABLERO FENOLICO	71
	CUBMF35	CUBERTERO 35		79
	CUBMF40	CUBERTERO 40		87
	CUBMF45	CUBERTERO 45		92
	CUBMF50	CUBERTERO 50		122
	CUBMF60	CUBERTERO 60		129
	CUBMF90	CUBERTERO 90		179
	CUBMF120	CUBERTERO 120		248
 <p data-bbox="137 593 512 683">  Base perforada cajón 60-90-120 Perforated base drawer </p> <p data-bbox="137 701 512 779">  Pivote de 15 cm. Pivot of 15 cm. Pivote de 20 cm. Pivot of 20 cm. </p>	FMPF60	FONDO PERFORADO 60	TABLERO FENOLICO	54
	FMPF90	FONDO PERFORADO 90		79
	FMPF120	FONDO PERFORADO 120		101
	CFMPF15	PIVOTE DE 15 cm.		5
	PO	SISTEMA PUSH OPEN PARA APERTURA DE PUERTA SIN TIRADOR	GRIS	5
	BISAGRAS CON FRENO			
	BFO	BISAGRA CON FRENO HETTICH (incluida base)	CROMO	3
	BI	BISAGRA CLIP INVERTIDA (incluida base)	CROMO	3
	EA	ABATIBLE		23
	COLGADOR LIBRA			
	CL	COLGADOR LIBRA		4
	COLGADOR OCULTO			
	CO	JUEGO COLGADOR OCULTO PARA MUEBLE ALTO		2
	COLGADOR MUEBLE BAJO ATLAS			
	CMBA	JUEGO COLGADOR PARA MUEBLE BAJO ATLAS		37

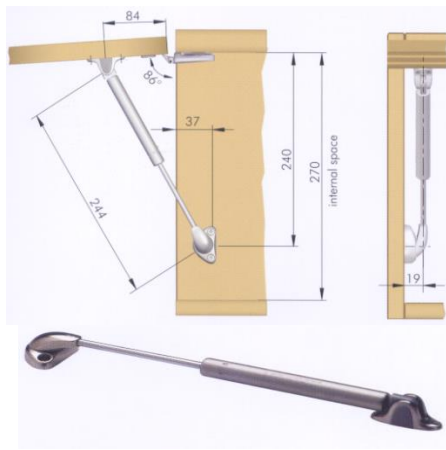

REF.	PG	ACAB.	GRIS	PUNTOS	20
PISTON DE GAS					

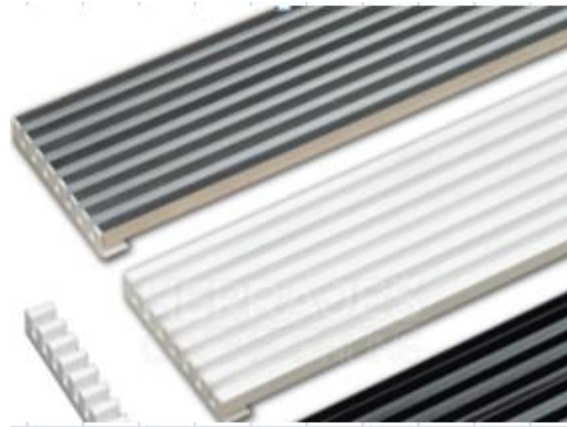

REF.	RVI	ACAB	INOX	PUNTOS	18
REF.	RVB	ACAB	BLANCO	PUNTOS	24
REJILA DE VENTILACION					

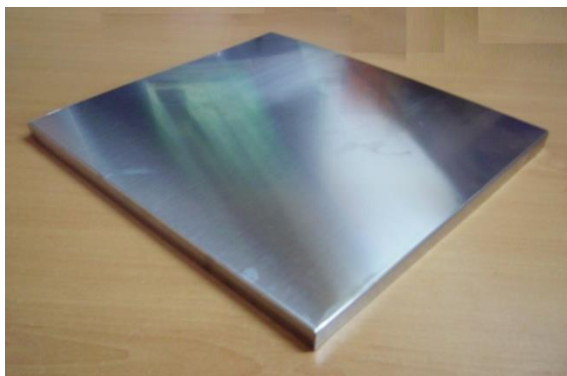

JUEGO PROTECTOR CAMPANA						
REF.	PCL23I	MED.	33X23	PUNTOS	23	INOX
REF.	PCL23B	MED.	33X23	PUNTOS	23	BLCO
REF.	PCL70I	MED.	33X70	PUNTOS	65	INOX
REF.	PCL90I	MED.	33X90	PUNTOS	80	INOX



REF.	RINCOMATIC70	ACAB	ALUMINIO	PUNTOS	91
REF.	RINCOMATIC90	ACAB	ALUMINIO	PUNTOS	103
RINCOMATIC-RINCOPLUS					



REFERENCIA	DESCRIPCION	ACABADO	PUNTOS
PBCM71	PIE DE BARRA - 71 ALTURA	GRIS MATE	19
PBNS71	PIE DE BARRA - 71 ALTURA	NIQUEL SATINADO	19
PBB71	PIE DE BARRA - 71 ALTURA	BLANCO	16
PBN71	PIE DE BARRA - 71 ALTURA	NEGRO	16
PBCM83	PIE DE BARRA - 83 ALTURA	GRIS MATE	22
PBNS83	PIE DE BARRA - 83 ALTURA	NIQUEL SATINADO	22
PBB83	PIE DE BARRA - 83 ALTURA	BLANCO	18
PBN83	PIE DE BARRA - 83 ALTURA	NEGRO	18



PAL	PATA ALUMINIO VISTA	ALUMINIO	8
-----	---------------------	----------	---



HULK	PATA HULK JUEGO DE 4	PLASTICO	4
------	----------------------	----------	---



MUEBLE PERSIANA COLOR ALUMINIO					
REF.	MPA45145	MED.	45X145	PUNTOS	549
REF.	MPA6090	MED.	60X90	PUNTOS	552
REF.	MPA60145	MED.	60X145	PUNTOS	574



ESPECIFICAR COLOR

MUEBLE PERSIANA PVC					
BLANCA-CARBONO-PIZARRA-INOX					
REF.	MPP60150	MED.	60X150	PUNTOS	462
REF.	MPP90150	MED.	90X150	PUNTOS	568

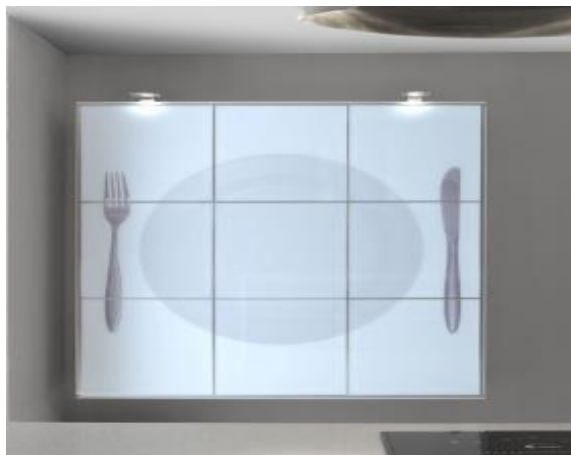

REF.	VID	ACAB.	VINILO	PUNTOS	340
PRECIO POR METRO CUADRADO					
IMPRESIÓN DIGITAL SOBRE CRISTAL					
IMAGEN A ELEGIR SEGÚN CATALOGO					



REF.	0413789	ACAB.	ÍNOX	PUNTOS	24
REJILLA INDUCCION ALTO 32 60 CM INOX					
REF.	0570189	ACAB.	ÍNOX	PUNTOS	28
REJILLA INDUCCION ALTO 32 90 CM INOX					

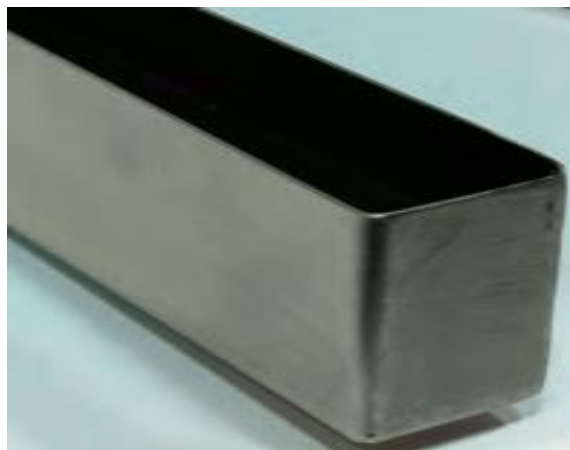

REF.	PRC60	ACAB.	ABS INOX	PUNTOS	12
PROTECTOR DE COSTADO 60X20X19 ABS ACAB.INOX					



REF.	0413792	ACAB.	CROMO MATE	PUNTOS	11
REJILLA AIREACIÓN ZÓCALO ALTO 70 MM ANCHO 445 MM					



REF.	SKAIMAN	ACAB.	MET. CROMO MATE	PUNTOS	32
SOPORTE KAIMAN CROMO MATE					



REF.	SKALA	ACAB.	cromo mate	PUNTOS	18
SOPORTE KALABRONE CROMO MATE					



REF.	SPCUBE	ACAB.	CROMO MATE	PUNTOS	22
SOPORTE CUBE					



REF.	SPGP	ACAB.	GRIS PLATA	PUNTOS	18
SOPORTE PELÍCANO					



REF.	FRM	ACAB.	GRIS	PUNTOS	59
ELEVABLE FREE MINI					
REF.	FRMV	ACAB.	GRIS	PUNTOS	82
ELEVABLE FREE MINI VITRINA					



REF.	FRF	ACAB.	GRIS	PUNTOS	86
ELEVABLE FREE FORTE					
REF.	FRFV	ACAB.	GRIS	PUNTOS	109
ELEVABLE FREE FORTE VITRINA					

KESSEBÖHMER



REF.	FSW	ACAB.	GRIS	PUNTOS	235
FREE SWING					

KESSEBÖHMER



REF.	FF	ACAB.	GRIS	PUNTOS	181
FREE FOLD					

KESSEBÖHMER



REF.	FS	ACAB.	GRIS	PUNTOS	182
FREE SLIDE					

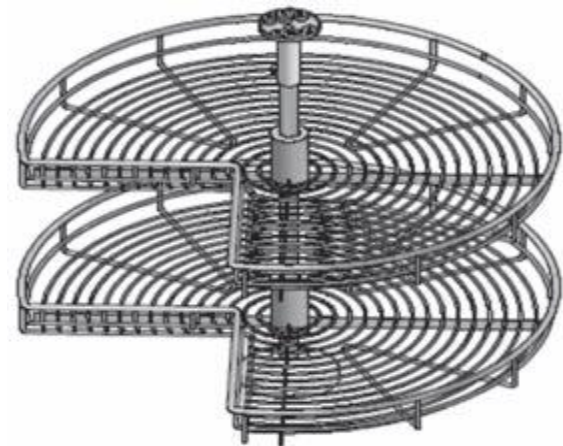

REF.	T270	ACAB.	CROMO	PUNTOS	268
TORNO 270° GIREVOLE PARA RBA-90X90					

KESSEBÖHMER



REF.	BTCR	ACAB.	CLASSIC-GRIS	PUNTOS	555
BANDEJA TRES CUARTOS PARA RBA ANGULAR					

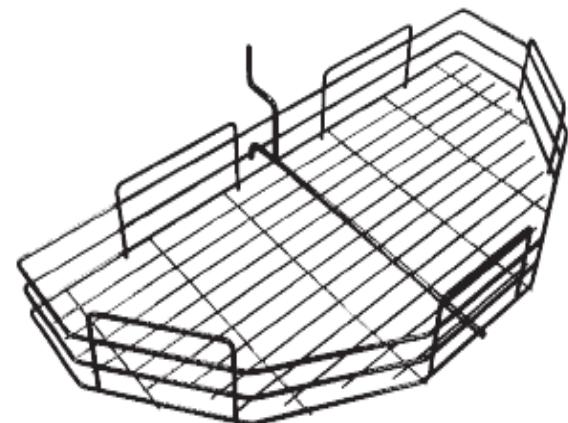

REF.	B180	ACAB.	CROMO	PUNTOS	119
JUEGO BANDEJAS SEMICIRCULAR 180° RINCON CIEGO					



REF.	0414191	ACAB.	VARILLA	PUNTOS	509
DINAMIC CORNER FRENO DCHO PUERTA MINIMO 40					
REF.	0414291	ACAB.	VARILLA	PUNTOS	509
DINAMIC CORNER FRENO IZDO PUERTA MINIMO 40					



REF.	DUETTO	ACAB.	VARILLA	PUNTOS	306
DUETTO PARA PUERTA DE 40 - 45					

KESSEBÖHMER



REF.	LEMANS45	ACAB.	CLASSIC-GRIS	PUNTOS	755
LEMAMS DOS BANDEJAS PARA PUERTA DE 40-45					
REF.	LEMANS60	ACAB.	CLASSIC-GRIS	PUNTOS	786
LEMAMS DOS BANDEJAS PARA PUERTA DE 50-60					



REF.	0417591	ACAB.	VARILLA	PUNTOS	401
HIDDEN CORNER PUERTA MINIMA40					

KESSEBÖHMER



REF.	ML2B	ACAB.	ARENA-CLASSIC	PUNTOS	326
MEDIA LUNA DOS BANDEJAS MINIMO PUERTA 45					

KESSEBÖHMER



REF.	MC	ACAB.	ARENA-CLASSIC	PUNTOS	1160
MAGIC CORNER PUERTA MINIMA 45					



ESTRUCTURA COLUMNA 4 CESTOS DE 113 A 149					
REF.	EC4C30	MED.	30	PUNTOS	644
REF.	EC4C40	MED.	40	PUNTOS	662
REF.	EC4C45	MED.	45	PUNTOS	685
REF.	EC4C60	MED.	60	PUNTOS	774



ESTRUCTURA COLUMNA 6 CESTOS DE 183 A 220					
REF.	EC6C30	MED.	30	PUNTOS	723
REF.	EC6C40	MED.	40	PUNTOS	746
REF.	EC6C45	MED.	45	PUNTOS	782
REF.	EC6C60	MED.	60	PUNTOS	893



CONVOY LAVIDO BLANCO CON 5 BANDEJAS					
REF.	CLB45200	MED.	45/ 180-200	PUNTOS	1737
REF.	CLB45220	MED.	45/ 200-220	PUNTOS	1746
REF.	CLB60200	MED.	60/ 180-200	PUNTOS	1877
REF.	CLB60220	MED.	60/ 200-220	PUNTOS	1886



K/ SET TANDEM ARENA STYLE ALTO MINIMO 170					
REF.	0421501	ANHO	45	PUNTOS	1607
REF.	0421701	ANHO	50	PUNTOS	1714
REF.	0421901	ANHO	60	PUNTOS	1879



REF.	0414920	ACAB.	GRIS	PUNTOS	473
i MOVE 60 INDIVIDUAL UNA BANDEJA					
REF.	0415120	ACAB.	GRIS	PUNTOS	496
i MOVE 90 INDIVIDUAL UNA BANDEJA					

KESSEBÖHMER



REF.	0426320	ACAB.	GRIS	PUNTOS	165
CLEANIG AGENT ANCHO 30 CM GUIA BASAL PARA AJUSTAR A CUALQUIER ANCHO					

KESSEBÖHMER



REF.	0426420	ACAB.	GRIS	PUNTOS	358
COOKING AGENT PARA BAJO DE 30					

KESSEBÖHMER



COMFORT II CLASSIC GRIS					
REF.	CCG20	MED.	20	PUNTOS	375
REF.	CCG30	MED.	30	PUNTOS	410
REF.	CCG40	MED.	40	PUNTOS	432



EXTRAIBLE 3 CESTAS C/FRENO CROMO					
REF.	0414491	MED.	30	PUNTOS	198
REF.	0414791	MED.	45	PUNTOS	210
REF.	0414991	MED.	60	PUNTOS	258



REF.	0420191	MED.	30	PUNTOS	181
REF.	0420291	MED.	40	PUNTOS	186
EXTRAIBLE BOTELLERO 2 CESTAS					



MINIBOTELLERO FRENO 50 FONDO					
REF.	0415091	MED.	15	PUNTOS	100
REF.	0415291	MED.	20	PUNTOS	125
REF.	0415391	MED.	25	PUNTOS	155



BOTELLERO PANERO C/FRENO

REF.	0410491	MED.	30	PUNTOS	177
REF.	0410591	MED.	35	PUNTOS	185
REF.	0410691	MED.	40	PUNTOS	185
REF.	0410791	MED.	45	PUNTOS	193



REF.	0499191	ACAB.	CROMO	PUNTOS	140
BANDEJA BAJO HORNO EXTRAÍBLE					



CACEROLERO INTERIOR ATIRA PARA DESPENSERO

REF.	CIAT45	MED.	45	PUNTOS	78
REF.	CIAT50	MED.	50	PUNTOS	80
REF.	CIAT60	MED.	60	PUNTOS	82



CACEROLERO INTERIOR ARCITECH PARA DESPENSERO

REF.	CIAR45	MED.	45	PUNTOS	126
REF.	CIAR50	MED.	50	PUNTOS	128
REF.	CIAR60	MED.	60	PUNTOS	130



REF.	ME60	ACAB.	BLANCO		733
------	------	-------	--------	--	-----

MESA EXTENSIBLE PARA B-60 EXTRACCION 80



REF.	0600920	ACAB	INOX-BLANCO	PUNTOS	723
------	---------	------	-------------	--------	-----

**MESA LUNCH PARA B-90 EXTRACCION 80 CM
CARGA 60KG FONDO MINIMO DE MUEBLE 54**



CESTOS MULTIUSOS VARILLA CROMO				
REF.	0413391	MED.	45	PUNTOS 118
REF.	0413591	MED.	60	PUNTOS 131
REF.	0413791	MED.	90	PUNTOS 153



REF.	0411391	MED.	60	PUNTOS	156
CACEROLERO VARILLA CROMO 60					



SALVA-SIFONES C/FRENO CROMO				
REF.	0415691	MED.	60	PUNTOS 168
REF.	0415891	MED.	90	PUNTOS 181



ESCURREPLATOS EXT C/FRENO CROMO				
REF.	0411991	MED.	60	PUNTOS 330
REF.	0412091	MED.	90	PUNTOS 381



CESTA ROPA EXTRAIBLE *45 FONDO				
REF.	0416091	MED.	40	PUNTOS 149
REF.	0416191	MED.	45	PUNTOS 156
REF.	0416291	MED.	60	PUNTOS 183



CESTA ROPA ABATIBLE *27 FONDO				
REF.	0416591	MED.	40	PUNTOS 77
REF.	0416691	MED.	45	PUNTOS 77
REF.	0416891	MED.	60	PUNTOS 84



REF.	0412720	ACAB.	BLANCO-GRIS	PUNTOS	30
------	---------	-------	-------------	--------	----

CONTENEDOR DE BASURA REDONDO DE 12 L.



REF.	0524489	ACAB.	INOX	PUNTOS	70
------	---------	-------	------	--------	----

CUBO PUERTA ÍNOX



REF.	0411620	ACAB.	BLANCO-NEGRO	PUNTOS	68
------	---------	-------	--------------	--------	----

CONTENEDOR DE BASURA EXTRAIBLE DE 17 L.



REF.	0411720	ACAB.	BLANCO	PUNTOS	104
------	---------	-------	--------	--------	-----

CONTENEDOR DE BASURA DOBLE DE 17 + 17 L.

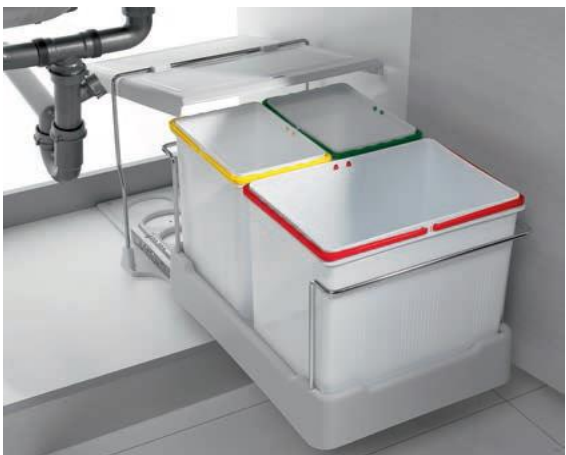

REF.	0411820	ACAB.	BLANCO	PUNTOS	113
------	---------	-------	--------	--------	-----

CONTENEDOR DE BASURA TRIPLE DE 17+8,5+8,5 L.



REF.	0412220	ACAB.	GRIS	PUNTOS	95
------	---------	-------	------	--------	----

CONTENEDOR DE BASURA DE 17 + 17 L.
PARA MUEBLE DE 60 CACEROLERO



REF.	0412420	ACAB.	GRIS-VERDE	PUNTOS	122
CONTENEDOR DE BASURA 17+17+17 L PARA CAC-90					
REF.	0412420	ACAB.	GRIS-VERDE	PUNTOS	140
CONTENEDOR DE BASURA 17+17+17 L PARA CAC-100					



REF.	0412620	ACAB.	GRIS TAPA GRIS	PUNTOS	22
CONTENEDOR SUELTO 13 L H-23 PARA GOLA					
REF.	0412520	ACAB.	GRIS TAPA VERDE	PUNTOS	22
CONTENEDOR SUELTO 13 L H-23 PARA GOLA					



REF.	0411489	ACAB.	INOX	PUNTOS	64
CUBO PARA ENCASTRAR EN ENCIMERAS 8 L.					



REF.	0412820	ACAB.	GRIS	PUNTOS	239
CUBO BASURA GRAN CAPACIDAD MAGNUM PARA B-45 PTA EXTRAIBLE 48 LITROS POR CUBETA					



REF.	CB2X30L	ACAB.	BICOLOR	PUNTOS	398
CONTENEDOR DE BASURA DOBLE DE 2X30 L. PARA MUEBLE DE 60 PUERTA EXTRAIBLE					



BASE NEBULA LED *32 ALUMINIO C/TRANSFORMADOR					
REF.	BNL60	MED.	60	PUNTOS	357
REF.	BNL90	MED.	90	PUNTOS	413
REF.	BNL120	MED.	120	PUNTOS	497

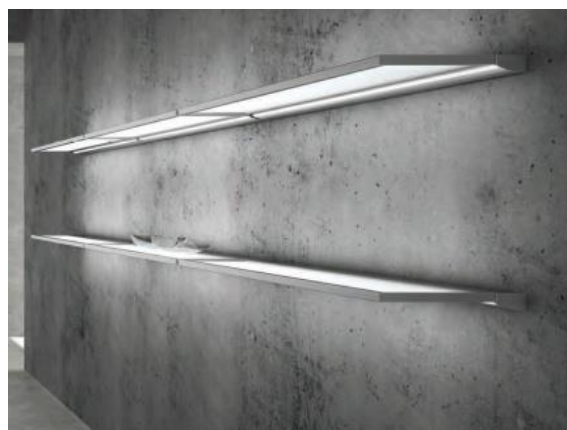

ESTANTE WING TLD *22 ALUM. C/TRANSFORMADOR					
REF.	0700887	MED.	60	PUNTOS	316
REF.	0700987	MED.	90	PUNTOS	371
REF.	0701087	MED.	120	PUNTOS	448



REF.	0701287	ACAB.	ALUMINIO	PUNTOS	265
SET 3 FOCOS SKATE 1.6 W C/TOUCH LED C/ALIMENTADOR					

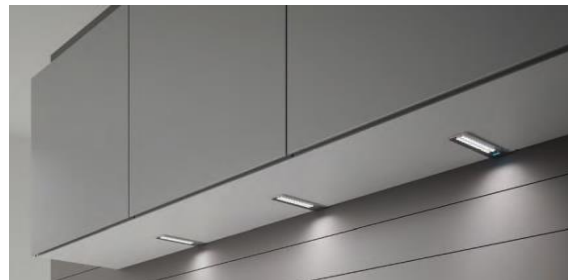

REF.	0701487	ACAB.	ALUMINIO	PUNTOS	265
SET 3 FOCOS LED KAYAK C/TOUCH LED C/ ALIMENTADOR					



REF.	0701687	ACAB.	ALUMINIO	PUNTOS	265
SET 3 FOCOS LED SMARTY C/TOUCH LED C/ALIMENTADOR					

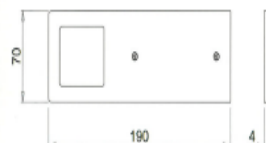

REF.	POLAR	ACAB.	ALUMINIO	PUNTOS	147
SET 2 FOCOS POLAR SIN SENSOR C/ALIMENTADOR					



REF.	TWIG	ACAB.	ALUMINIO	PUNTOS	234
PERFIL DE SUPERFICIE					
PERFIL TWIG 2 METROS+COBERTOR+TAPAS+CLIPS CON ALIMENTADOR + TIRA DE LED INTERIOR					



REF.	SKYLINE	ACAB.	ALUMINIO	PUNTOS	219
PERFIL PARA ENCASTRAR					
SKYLINE 2 METROS FRONTAL-TRASERO+COBERTOR+FIJACION CON ALIMENTADOR+TIRA DE LED INTERIOR					



FLEXILED CON TRANSFORMADOR Y CABLEADO					
REF.	FLEX50	MED.	50-0701901	PUNTOS	71
REF.	FLEX100	MED.	100-0700501	PUNTOS	99
REF.	FLEX200	MED.	200-0702001	PUNTOS	151



REF.	DIVA	ACAB.	ALUMINIO	PUNTOS	260
PERFIL PARA ENCASTRAR					
PERFIL DIVA 2 METROS + COBERTOR + TAPAS CON ALIMENTADOR + TIRA DE LED INTERIOR					

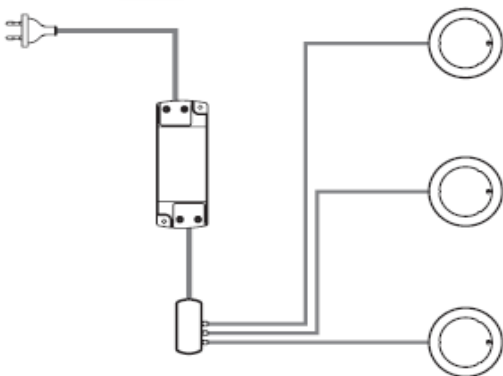

REF.	0701401	ACAB.		PUNTOS	42
KIT TRANSFORMADOR 15/12 220-240/12V					



NECESITA TRANSFORMADOR					
REGLETA LED LEAF ALUMINIO C/SENSOR					
REF.	0701887	MED.	60 - 2,6 W	PUNTOS	166
REF.	0701987	MED.	90- 4,1W	PUNTOS	199
REF.	0702087	MED.	120- 5,5W	PUNTOS	232



NECESITA TRANSFORMADOR

REF.	FM	ACAB.	CROMO MATE	PUNTOS	31
FOCO METRIS 1,6 W					



NECESITA TRANSFORMADOR

REF.	FSR	ACAB.	CROMO MATE	PUNTOS	38
FOCO SPACER RECTO 1,6 W					



NECESITA TRANSFORMADOR

REF.	FSO	ACAB.	CROMO MATE	PUNTOS	38
FOCO SPACER OBLICUO 1,6 W					



NECESITA TRANSFORMADOR

REF.	0701787	ACAB.	ALUMINIO	PUNTOS	100
FOCO LED YORK ALUMINIO CON SENSOR 1,6W					



REF.	0700287	ACAB.	ALUMINIO	PUNTOS	204
EVOLINE PORT REDONDO INCASSO 3 ENCHUFES					





REF.	0700690	ACAB.	ÍNOX	PUNTOS	188
ENCHUFE TWIST INOX 2 TOMAS					

DISEÑO	REFERENCIA	DESCRIPCIÓN	ACABADO	PUNTOS	
CAMPANA - CADIZ  ALTURA 90 cm F.C. 50 cm.	CCRO70	AMP. CADIZ 70 ROBLE-HAYA-PIN		701	
	CCRO80	AMP. CADIZ 70 ROBLE-HAYA-PIN	BARNIZADO	725	
	CCRO90	AMP. CADIZ 70 ROBLE-HAYA-PIN		790	
	CCCA70	CAMP. CADIZ 70 CASTAÑO		718	
	CCCA80	CAMP. CADIZ 80 CASTAÑO	BARNIZADO	742	
	CCCA90	CAMP. CADIZ 90 CASTAÑO		802	
	CCCE70	CAMP. CADIZ 70 CEREZO		785	
	CCCE80	CAMP. CADIZ 80 CEREZO	BARNIZADO	809	
	CCCE90	CAMP. CADIZ 90 CEREZO		861	
	CAMPANA - JAEN  ALTURA 90 cm F.C. 50 cm.	CJRO70	AMP. JAEN 70 ROBLE-HAYA-PIN		754
CJRO80		AMP. JAEN 80 ROBLE-HAYA-PIN	BARNIZADO	935	
CJRO90		AMP. JAEN 90 ROBLE-HAYA-PIN		970	
CJCA70		CAMP. JAEN 70 CASTAÑO		1102	
CJCA80		CAMP. JAEN 80 CASTAÑO	BARNIZADO	1210	
CJCA90		CAMP. JAEN 90 CASTAÑO		1318	
CJCE70		CAMP. JAEN 70 CEREZO		1426	
CJCE80		CAMP. JAEN 80 CEREZO	BARNIZADO	1534	
CJCE90		CAMP. JAEN 90 CEREZO		1642	
				1750	
				1086	
CAMPANA - MILAN  ALTURA 110 cm F.C. 50 cm.		CMRO70	AMP. MILAN 70 ROBLE-HAYA-PIN		647
	CMRO80	AMP. MILAN 80 ROBLE-HAYA-PIN	BARNIZADO	691	
	CMRO90	AMP. MILAN 90 ROBLE-HAYA-PIN		804	
	CMCA70	CAMP. MILAN 70 CASTAÑO		674	
	CMCA80	CAMP. MILAN 80 CASTAÑO	BARNIZADO	714	
	CMCA90	CAMP. MILAN 90 CASTAÑO		818	
	CMCE70	CAMP. MILAN 70 CEREZO		746	
	CMCE80	CAMP. MILAN 80 CEREZO	BARNIZADO	784	
	CMCE90	CAMP. MILAN 90 CEREZO		893	
	CAMPANA - ODIEL  ALTURA 110 cm F.C. 50 cm.	CORO80	AMP. ODIEL 80 ROBLE-HAYA-PIN	BARNIZADO	819
CORO90		AMP. ODIEL 90 ROBLE-HAYA-PIN		866	
COCA80		CAMP. ODIEL 80 CASTAÑO	BARNIZADO	859	
COCA90		CAMP. ODIEL 90 CASTAÑO		913	
COCE80		CAMP. ODIEL 80 CEREZO	BARNIZADO	920	
COCE90		CAMP. ODIEL 90 CEREZO		967	
CAMPANA - 5 LADOS  ALTURA 110 cm		CHI-80-D5L	CAMPANA 80 DECOR. 5 LADOS	BARNIZADO	625
	CHI-90-D5L	CAMPANA 90 DECOR. 5 LADOS	BARNIZADO	625	

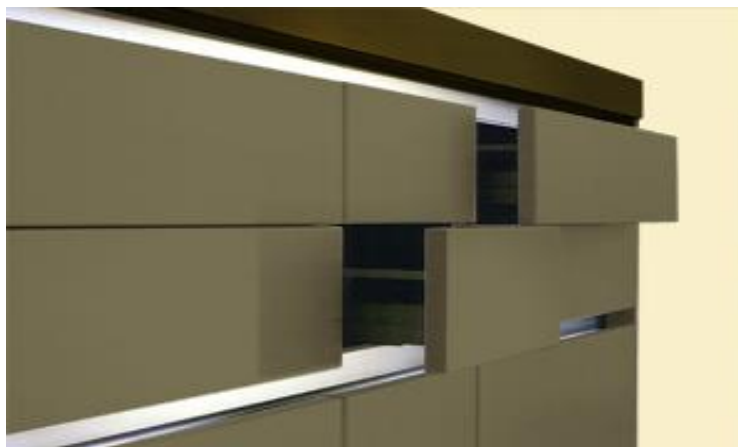
PERFIL GOLA COLOR / ALUMINIO / BLANCO / NEGRO



ESTE PERFIL SE PUEDE APLICAR PARA NUESTROS MODELOS DE PUERTAS LISAS

DISEÑO	REFERENCIA	DESCRIPCIÓN	ACABADO	PUNTOS
	GOLA	PERFIL GOLA (PRECIO METRO LINEAL) TIRAS DE 4 METROS	ALUMINIO MATE	26
	GOLAB		BLANCO	34
	GOLAN		NEGRO	34
	SPGOLA	SOPORTE CLIP SUJECCION	ALUMINIO MATE BLANCO NEGRO	6
	RGOLA	RINCON GOLA ESQUINA GOLA TAPA GOLA	PLASTICO	6
	EGOLA		PLASTICO	6
	TGOLA		PLASTICO	6
	PMA	PERFIL PARA MUEBLE ALTO (PRECIO METRO LINEAL)	ALUMINIO MATE BLANCO NEGRO	16
	GOLAV GOLAVB GOLAVN	PERFIL GOLA CENTRAL (PRECIO METRO LINEAL) TIRAS DE 2,55 MTROS	ALUMINIO MATE BLANCO NEGRO	45 59 59
	GOLAL GOLALB GOLALN	PERFIL GOLA LATERAL (PRECIO METRO LINEAL) TIRAS DE 2,55 MTROS	ALUMINIO MATE BLANCO NEGRO	39 51 51

CONSIDERACIONES

REFERENCIA

INCREMENTOS POR ADAPTACION DEL CASCO

	* Incrementos a muebles especiales de fondo		
IF	Muebles altos ó bajos de menos fondo	27	PUNTOS
IFC	Muebles columna	38	PUNTOS
	* Incrementos a muebles con mas fondo		
IFA+	Muebles altos con fondo + de 33 a 58 cm.	42	PUNTOS
IFB+	Muebles bajos con fondo + de 58 a 70 cm.	58	PUNTOS
IFC+	Muebles columna con fondo + de 58 a 70 cm.	88	PUNTOS
	* Incrementos a muebles con mueca		
IM	Muebles altos ó bajos con mueca	52	PUNTOS
IMC	Muebles columna con mueca	72	PUNTOS

INCREMENTOS POR ADAPTACION DEL CASCO Y PUERTA

* Incrementos a muebles especiales

Muebles especial en alto o ancho, extractificados y melaminas + **25%** inmediato superior

Muebles especial alto o ancho en polilaminados, maderas y lacados + **30%** inmediato superior

Muebles en chaflan, extractificados y melaminas + **30%** inmediato superior

Muebles en chaflan, polilaminados, maderas y lacados + **35%** inmediato superior

- * Todos los muebles están valorados sin tirador, por lo que hay que incrementar el precio del tirador. Dicho precio está en la tarifa de tiradores y siempre se cobrará aparte de los muebles. El precio variará dependiendo de la categoría y del diseño.
- * Los pedidos se deben pasar por fax ó correo electrónico
- * Los modelos que por defecto se fabrican con armazon blanco y se pidan con el armazon en diseño tendran un incremento de un 4 %.
- * Todos los muebles tienen un código , una descripción y un precio en puntos, La forma de saber el código de un artículo mirando nuestra tarifa es la siguiente.
- * Los pedidos se consideran en firme , una vez trascurridas 24 horas desde su recepción del mismo en nuestras oficinas y no se admitiran cambios ni anulaciones de modulos ni puertas que se consideren especiales.
- * En los modelos de madera , al ser producto naturales , pueden tener cambios de color o tonalidad, por lo que un cambio de dichas características, no supone que sea un producto defectuoso.

1ª CODIGO MODELO	Desde la serie 100 a la 603
2º REF.	Formado por letras
3ª ANCHO	Anchura del mueble
4º ALTO	Altura del mueble (excepto muebles bajos)
5º 1P	Solo en caso de muebles de 60 de ancho

Estos datos estan en **negrita** en nuestra tarifa

CONDICIONES GENERALES DE VENTA

EDICIÓN - 01 / 2017 - ENERO

Toda la tarifa esta cotizada en puntos. El precio del punto es de:

0,48 EUROS

* Se podra optar por las siguientes formas de pago

RECIBO BANCARIO 30 DIAS DE FACTURA..... 1,5%

Para obras y exposiciones pueden existir ofertas especiales. Para ello deberan dirigirse a nuestro departamento comercial

PASOS PARA REALIZAR MEJOR TUS PEDIDOS

1. Reflejar el cliente, la dirección, población y fecha; además de la referencia de su cliente válida para ayudar a localizar su pedido en posibles reclamaciones.
2. Indicar el modelo o serie junto con el número de tarifa:
 - ⇒ Si es un modelo de formica tener en cuenta si va combinado con otro y se indicaran en la columna de color los muebles del modelo que menos predomina (líneas 2,8 y 12).Tambien hay que tener en cuenta el PVC de ambos modelos ya que pueden tener el mismo, distinto o a juego con la puerta.
 - ⇒ Si es de madera indicar el color del barnizado.
3. En la relación de muebles es muy importante colocar primero los muebles altos, luego los bajos y por ultimo los columnas (siempre con las referencias de la tarifa). Además poner la mano (I_D) si es izquierdo o derecho (lineas 1,9,10,11 y 14), si algún mueble es de fondo diferente al normal indicar su fondo en (F.C) (lineas 2 y 10) y no olvidar incluir a que lado del mueble van los costados vistos si es que los hay, en la columna de COST. VIS (lineas 3 y 10).

Según sea el tipo de mueble destacaremos una serie de características en su descripción:

- ⇒ Muebles vitrina: Indicaremos el tipo de cristal (línea 2).
 - ⇒ Muebles escurreplatos (línea 4): Material de las varillas (inox, epoxi blanco o zincados) y si llevan bandeja vierteaguas. Si son inox hay que aumentar la varilla inos según medida I.El . (línea 5)
 - ⇒ Muebles fregadero (línea 11): si llevan bandeja.
 - ⇒ Reflejar en rinconeras altas si son normales o angulares. (línea 6).
 - ⇒ En los botelleros poner si son de aros, cuadros, rombos y cuellos solo en madera... (línea 8).
 - ⇒ En terminales tanto altos como bajos indicar si son, sin barandilla, con barandilla solo en modelos de madera y con puerta (línea 9).
 - ⇒ En los muebles de cajones y caceroleros reflejaremos el tipo de cajon que puede ser metálico o metálico con frenos (lineas 12 y 13).
 - ⇒ En soportes placa indicar si lleva rejilla de ventilación con su color (inox, blanca, negra) y si lleva cajón bajo zocalo.
 - ⇒ En columnas si las puertas no tienen medida normal y son especiales indicar la medida de sus puertas.
 - ⇒ En las rinconeras bajas poner el lado al que va la parte ciega y la medida de la puerta que abre.
 - ⇒ Los muebles especiales realizar un dibujo con todas sus medidas.
4. Indicaremos en los complementos las puertas costado kit, galerías Etc.
 5. En los elementos lineales no olvidar los colores y modelos. Sobre todo en las encimeras indicaremos el modelo y el grupo además si llevan chaflán indicar el lado al que va.
 6. Por último comprobar bien el número de patas, chapas y si lleva tirador el número de los que necesita con su referencia y si van colocados en la puerta o sueltos.

MEDIDAS

ALTURA TOTAL : 216

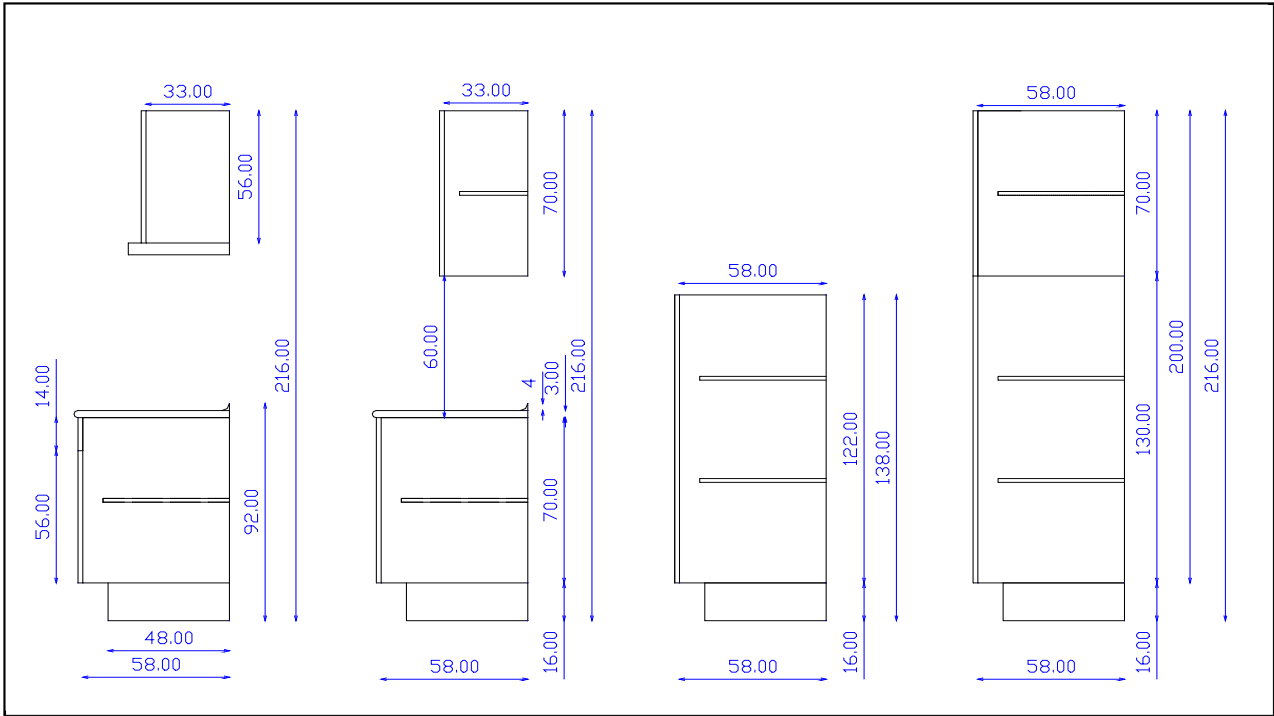

MODULOS
EXTRAPLANAS
ALTURA TOTAL :216

MODULOS
ALTO 70
ALTURA TOTAL :216

MODULOS
SEMICOLUMNAS
ALTURA TOTAL :216

MODULOS
COLUMNAS
ALTURA TOTAL :216

ALTURA TOTAL : 236

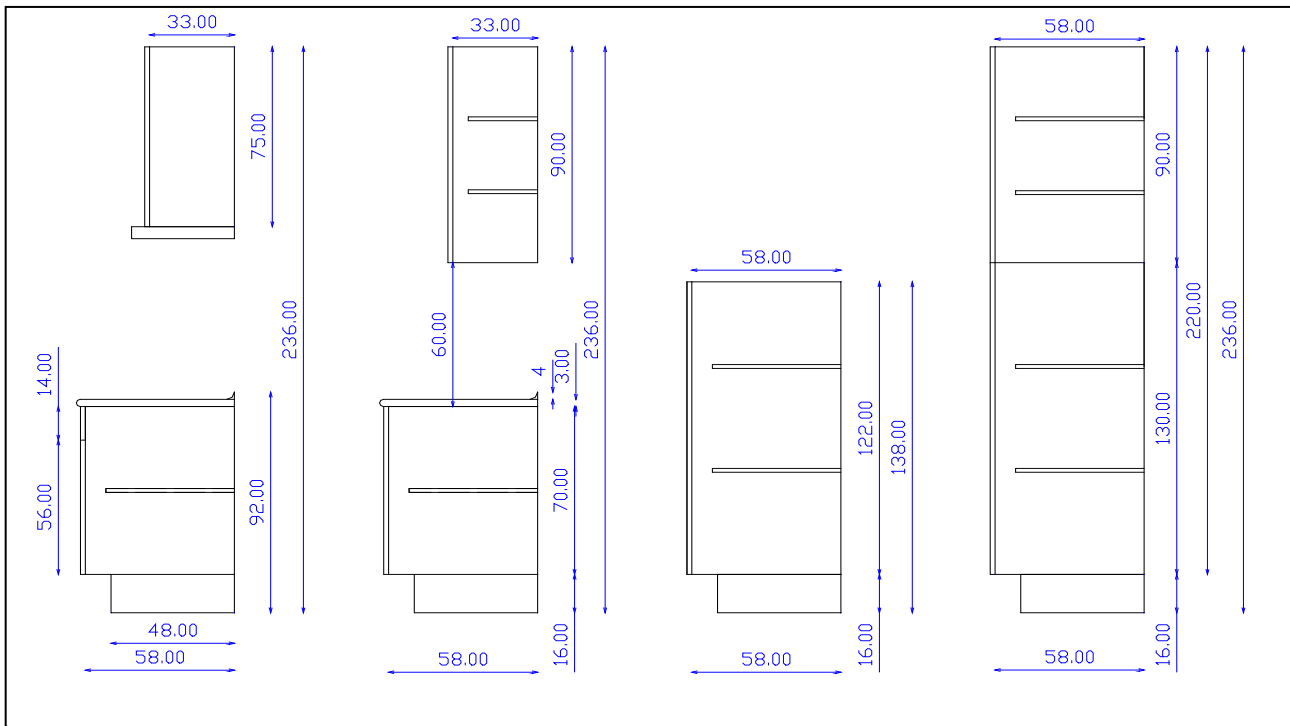

MODULOS
EXTRAPLANAS
ALTURA TOTAL :236

MODULOS
ALTO 90
ALTURA TOTAL :236

MODULOS
SEMICOLUMNAS
ALTURA TOTAL :236

MODULOS
COLUMNAS
ALTURA TOTAL :236

EJEMPLO DE PEDIDO

CINCOGINA S.L.
Ctra Ubeda-Malaga, Km, 37.300 23100 - MANCHA REAL (JAEN) TELF: 953 350 240 FAX: 953 350 357 www.cincoquina.com

FECHA	1 de sep de 08	PEDIDO
CLIENTE	PROMUSA	
DIREC.	C/ Tetuán, 24	TIRADOR:
POBL.	MADRID	
S/REF:	Lorenzo Peinado Cobo	3003 montado
MODELO	Miño	TARIFA
COLOR:	Blanco/ Naranja	04
CANTO	A Juego	

L	CT	REFERENCIA	I-D	F.C.	COST.VIS.	T.	COLOR	DESCRIPCION
1	1	A-40x90	I				
2	1	AV-60x70		20			Naranja	Vitrina cristal blanco
3	1	A-80x90			Derecho		Costado derecho visto s/plano 1
4	1	ES-90x70					varillas y bandeja inox.
5		I.EI-90					Incremento por varillas inox
6	1	RINL-60x90					Angular
7	1	ACEX-60x75					Extraplana
8	1	BOA-15x90					Naranja	Botellero con aros de cromo
9	1	TCP-30x90	D				Terminal con puerta
10	1	B-40	I	46	Izquierdo		Costado izquierdo visto
11	1	SFB-45	D				Con bandeja
12	1	BTCA-50					Cajones con freno (1º y 3º Naranja)
13	1	BVA-60					Verdulero con 2 cajones y 1 cacerolero con freno
14	1	SPLH-60					Con rejilla metalica
15	1	BBP-30					Botellero panero inox
16	1	RBAC-90x90					Con cestos giratorios inox
17	1	CHM-60x220					Horno y microondas
18							
19							
20							

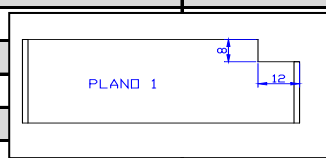

COMPLEMENTOS								
1	1	R-5X236						Regleta de 5 x236 de altura
2	1	PCL-60x236						Puerta costado columna lisa de 60x236
3	1	PCL-35x236						Costado para galeria
4	1	PFL-60x185						Panel frigo liso 60x185
5	1	KI						Kit microondas blanco
6								
7								
8								
9								

ELEMENTOS LINEALES						
CT.	DESCRIPCION	MEDIDA		REFERENCIA		
1	ENCIMERA	360x(63)		IC-18-ESSE haya / GRUPO 1		
1	ENCIMERA	180x(63) Terminal derecho		IC-18-ESSE haya / GRUPO 1		
1	COPETE	400		Aluminio		
1	ZOCALO	360		Miño naranja		
1	PERFIL ZOC.	360		Transparente		
2	CORNISA	360+360		Naranja		
	PORTALUZ					
1	J.UNION	2	J.TERM.	J.EMP.		
2	TER.COP.	3	RINC.COP	ES. COP		
8	PATAS	6	CHAPAS	8	CLIP.	
27	Nº TIRADOR:			PRECIO :		

FORMATO PARA REALIZAR PEDIDOS

CINCOCCINA S.L.	
Ctra Ubeda-Malaga, Km, 37.300 23100 - MANCHA REAL (JAEN) TELF: 953 350 240 FAX: 953 350 357 www.cincocina.com	

FECHA		PEDIDO
CLIENTE		
DIREC.		TIRADOR:
POBL.		
S/REF:		
MODELO		TARIFA
COLOR:		
CANTO		

L	CT	REFERENCIA	I-D	F.C.	COST.VIS.	T.	COLOR	DESCRIPCION
1							
2							
3							
4							
5							
6							
7							
8							
9							
10							
11							
12							
13							
14							
15							
16							
17							
18							
19							
20							

COMPLEMENTOS								
1								
2								
3								
4								
5								
6								
7								
8								
9								

ELEMENTOS LINEALES					
CT.	DESCRIPCION	MEDIDA		REFERENCIA	
	ENCIMERA				
	ENCIMERA				
	COPETE				
	ZOCALO				
	PERFIL ZOC.				
	CORNISA				
	PORTALUZ				
	J.UNION	J.TERM.		J.EMP.	
	TER.COP.	RINC.COP		ES. COP	
	PATAS	CHAPAS		CLIP.	
	Nº TIRADOR:				PRECIO :

5cina[®]
MODA EN COCINAS

5cina[®]
el futuro es ahora

5C. CINCOCINA[®]
mobiliario de cocina

5C. CINCOCINA
mobiliario de cocina

