

INDICE DE MODELOS

| MODELO | DESCRIPCION | TARIFA | PAGINA |
|--|---|--------|--------|
| LAMINADO BAJA PRESIÓN | | | |
| SUIZA | LAMINADO 19 mm. (4 CANTOS) | 100 | |
| AUSTRIA | LAMINADO 19 mm. (4 CANTOS) | 100 | |
| ALABAMA | LAMINADO 19 mm. (4 CANTOS PVC. A JUEGO) | 200 | |
| TORONTO | LAMINADO 19 mm.ACABADO PIEDRA (4 CANTOS PVC JUEGO) | 200 | |
| BOSTON | LAMINADO 19 mm. (4 CANTOS PVC. A JUEGO) | 200 | |
| CANADA | LAMINADO 19 mm. (4 CANTOS PVC JUEGO) | 201 | |
| SIL | LAMINADO 19 mm. (4 CANTOS PVC) PORO SINCRONIZADO | 202 | |
| LAMINADO ALTA PRESIÓN | | | |
| MIÑO GRUPO 1 | ESTRATIFICADO BRILLO 20 mm. (4 CANTOS PVC A JUEGO) | 300 | |
| LUGO | ESTRATIFICADO MATE 20 mm. (4 CANTOS PVC JUEGO) | 300 | |
| MIÑO GRUPO 2 | ESTRATIFICADO BRILLO COLORES 20 mm. (4 CANTOS PVC A JUEGO) | 400 | |
| LAMINADO BAJA PRESIÓN LACADO | | | |
| LUXEMBURGO (ALTO BRILLO) | SOPORTE MDF 19 MM LAMINADO Y LACADO ALTO BRILLO | 400 | |
| DETROIT (MATE ANTI HUELLA) | SOPORTE MDF 19 MM LAMINADO Y LACADO SUPER MATE | 400 | |
| LAMINADO BAJA PRESION CON UÑERO INTEGRADO | | | |
| LISBOA | LAMINADO 19 mm CON TIRADOR JOTA EN LAMINA DE PVC | 400 | |
| POLILAMINADO | | | |
| MODELOS POLILAMINADOS | POLILAMINADO 19 MMS | 500 | |
| PET | | | |
| OSLO | PET COLORES S/MUESTRARIO DE 22 MM | 500 | |
| LACADO | | | |
| JANDULA LACADO BLANCO BRILLO | MDF 19 MMS LACADO BLANCO BRILLO - MATE | 503 | |
| ZAIRE LACADO BLANCO BRILLO | MDF 19 MMS LACADO BLANCO BRILLO - MATE | 503 | |
| JANDULA LACADO COLORES | MDF 19 MMS LACADO COLORES BRILLO - MATE | 601 | |
| ZAIRE LACADO COLORES | MDF 19 MMS LACADO COLORES BRILLO - MATE | 601 | |
| MASA, ALASKA, NANTES(NOVEDAD) | MDF 22 MMS LACADO BLANCO BRILLO - MATE | 601 | |
| MASA, ALASKA, NANTES(NOVEDAD) | MDF 22 MMS LACADO COLORES BRILLO - MATE | 602 | |
| AUSTRAL BLANCO, ANTIQUE, XATIVA, DOHA, EVEREST, VEGA 45°, MAELLA | MDF 22 MMS LACADO ACABADO BRILLO MATE SALVO MODELO MAELLA MDF 19 MMS | 602 | |
| AUSTRAL, GANTE TIRADOR NOGAL | MDF 22 MMS LACADO COLORES BRILLO MATE | 612 | |
| MADERA | | | |
| COLUMBIA | MARCO FRESNO MACIZO, PLAFON RECHAPADO | 600 | |
| VISTULA | MARCO ROBLE MACIZO Y PLAFON RECHAPADO HUESO | 601 | |
| DEVA | MARCO ROBLE MACIZO Y PLAFON RECHAPADO | 601 | |
| EBRO | MARCO ROBLE MACIZO Y PLAFON RECHAPADO ENVEJECIDO | 601 | |
| NASI | PUERTA RECHAPADA EN ROBLE NUDOS | 601 | |
| ALASKA FRESNO (NOVEDAD) | FRESNO MACIZO | 602 | |
| SELENE | CHAPA ROBLE NUDOS RUSTICO | 602 | |
| PALMA | CHAPA NOGAL | 612 | |
| KENYA | ROBLE MACIZO | 630 | |

CINCOCINA S.L.

Telefono- 953 35 02 40

Ctra. Ubeda-Malaga km. 37,300
23100 Mancha Real (Jaen)

Mail- pedidos@cincocina.com

Cincocina S.L. es un fabricante de cocinas con gran experiencia en el mercado nacional desde 1984. Año tras año hemos ido creciendo de forma exponencial hasta la fecha actual, momento en el que seguimos a la vanguardia en el mercado.

Con una superficie de más de 16.000 metros cuadrados, nuestra fábrica tiene una gran capacidad de producción. En ella contamos con unas instalaciones preparadas para la fabricación masiva de muebles de cocina cumpliendo con los máximos estándares de calidad.

Nuestro equipo humano formado por más de 80 personas está a su disposición, con el compromiso de servir a nuestros clientes.

Nos significa nuestra amplia gama de modelos así como por disponer de un catálogo técnico muy completo con el que se puede realizar cualquier composición.

Además, contamos con un canal de distribución propio que nos permite suministrar nuestros productos a cualquier punto de España, Francia y Portugal en un reducido plazo de tiempo.

SUIZA

LAMINADO 19 mm. (4 CANTOS)

TARIFA

100



FRESNO GRIS



NOGAL CLARO

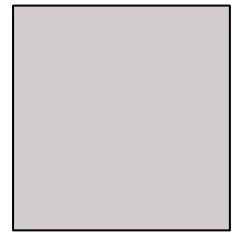

GRIS LUNA

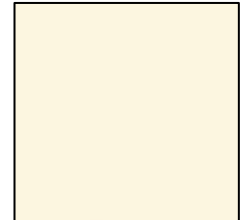

CREMA



ROBLE TRUFA



ROBLE NATURAL

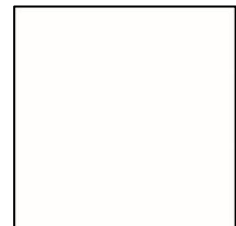

BLANCO

AUSTRIA

LAMINADO 19 mm. (4 CANTOS)

TARIFA

100



ROBLE AMUNDSEN



COTTON



BASALTO



ANTRACITA

ALABAMA

LAMINADO 19 mm. (4 CANTOS)

TARIFA

200



BORNEO REBECO



PINO RUSTICO OSCURO

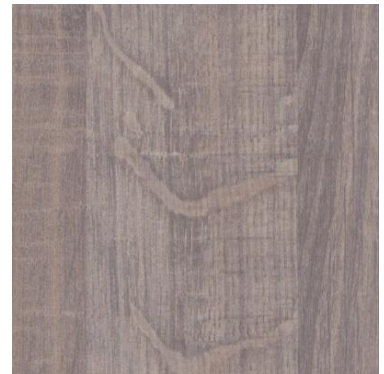

ROBLE GRIS



HACIENDA BLANCO



WOODLINE CREMA



DRIFTWOOD



NOGAL DEL PACIFICO

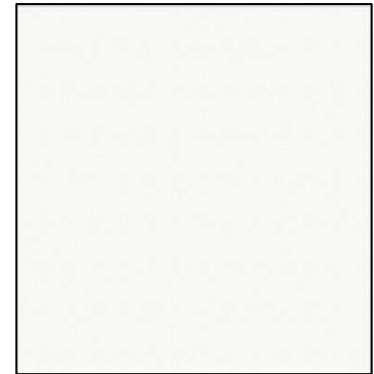

BLANCO PREMIUM

TORONTO

LAMINADO 19 mm. (4 CANTOS)

TARIFA

200



CEMENTO CLARO



CEMENTO OSCURO

BOSTON

LAMINADO 19 mm. (4 CANTOS)

TARIFA

200



ROBLE NEBRASKA



PINO ALAND



PINO CHAMPAN



ARCE AMERICANO



ARCE NATURAL



MADERA BLANCA



ROBLE ANTIGUO



PINO HAVANA



PINO CENIZA



GRIS ARTICO



AZUL TIFFANY



AZUL AHUMADO

CANADA

LAMINADO 19 mm. (4 CANTOS)

TARIFA

201



NUDOS (NOVEDAD)



EUCALIPTO (NOVEDAD)



PINO BLANCO



PINO JACKSON



PINO DECAPE

SIL

LAMINADO 19 MM (4 CANTOS) PORO SINCRONIZADO.

TARIFA 202



HALIFAX NATURAL (NOVEDAD)



HALIFAX TABACO (NOVEDAD)



BLANCO ACABADO PORO



NATURAL

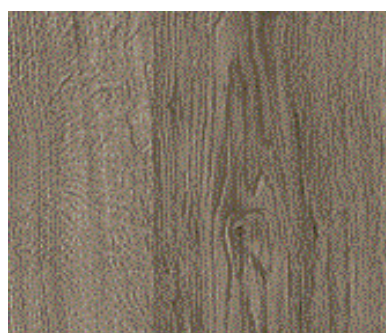

GRIS

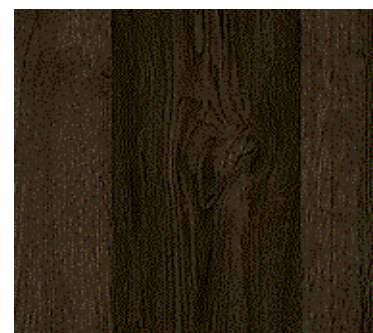

WENGUE



NOGAL CLARO



NOGAL OSCURO



ROBLE BLANCO

MIÑO

ESTRATIFICADO BRILLO 20 mm. (4 CANTOS)

TARIFA 300

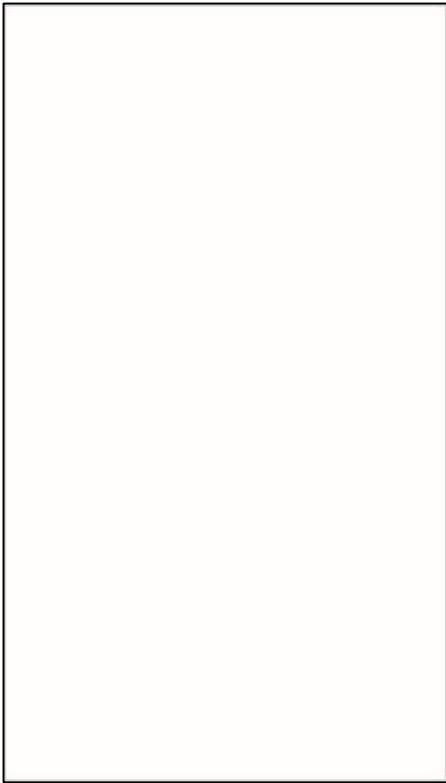

BLANCO BRILLO



GRIS PERLA BRILLO (NOVEDAD)

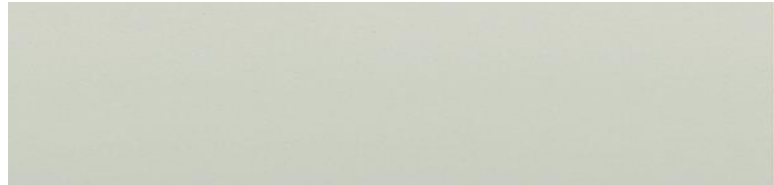

CICLONE BRILLO (NOVEDAD)



TIERRA BRILLO (NOVEDAD)

MIÑO

ESTRATIFICADO BRILLO 20 mm. (4 CANTOS)

TARIFA 400

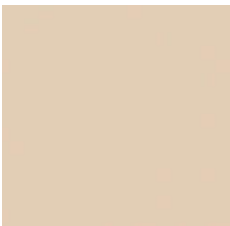

VISON BRILLO



PISTACHO BRILLO

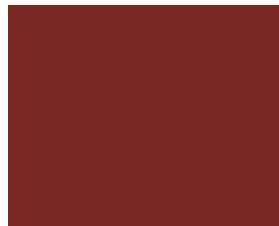

GRANATE BRILLO

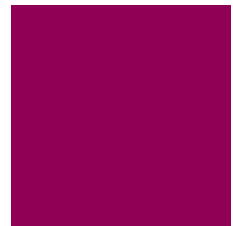

BERENJENA BRILLO

LUGO

ESTRATIFICADO MATE 20 mm. (4 CANTOS)

TARIFA 300



BURDEOS MATE



BLANCO MATE

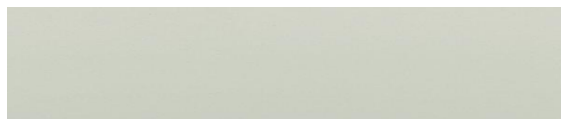

CICLONE MATE



TIERRA MATE

LUXEMBURGO

LAMINADO LACADO ALTO BRILLO
SOPORTE MDF 19 MMS

TARIFA 400

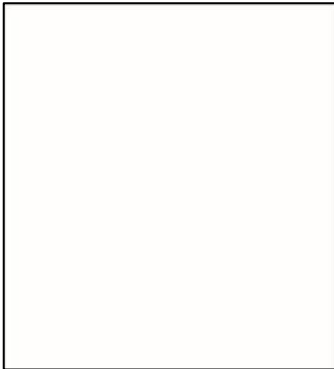

BLANCO BRILLO

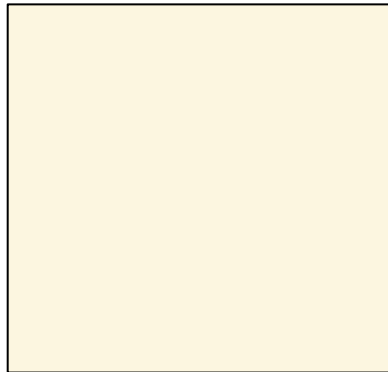

CREMA BRILLO



GRIS CLARO BRILLO



ARENA BRILLO



ALMENDRA BRILLO



AGUAMARINA BRILLO



ROJO BRILLO

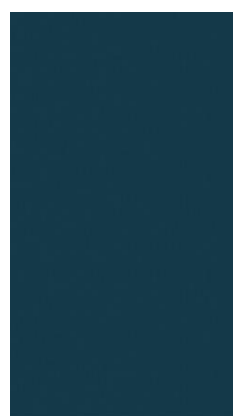

AZUL BRILLO



**MARENCO
BRILLO**

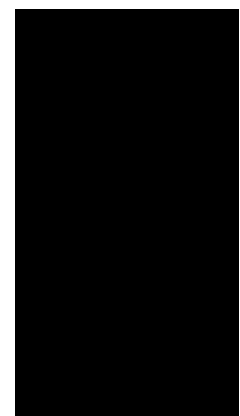

**NEGRO
BRILLO**

DETROIT

LAMINADO LACADO SUPER MATE. TACTO SEDA
TRATAMIENTO ANTIHUELLA. SOPORTE MDF 19 MMS

TARIFA 400

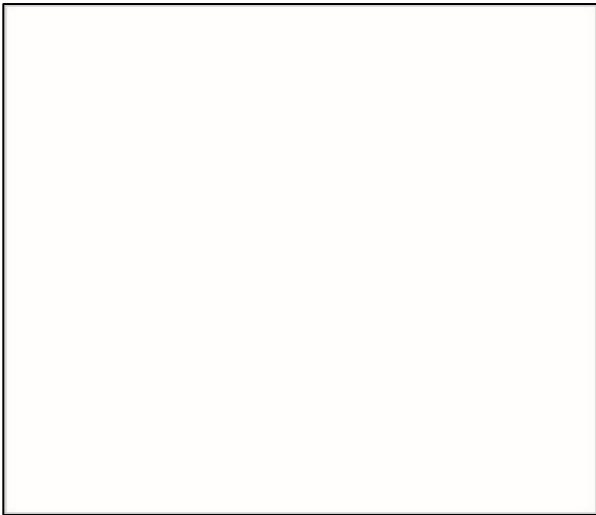

BLANCO ALPINO SUPER MATE



GRIS CLARO SUPER MATE



CACHEMIRA SUPER MATE



MACADAN SUPER MATE



GRAFITO SUPER MATE



NEGRO SUPER MATE

LISBOA

LAMINADO 19 MMS. TIRADOR JOTA PVC.

TARIFA 400



NOGAL



OLMO



BLANCO



CEREZO CLARO



GRIS



HAYA CLARO

MODELOS POLILAMINADOS ACABADO MATE

TARIFA 500



ESTOLA



ESTOLA S/RAYAS



TER



TAJO



APOLO

MODELO PET COLORES S/MUESTRARIO 22 MMS

TARIFA 500



OSLO

MODELOS LACA ACABADO BRILLO Y MATE 19 MMS



JANDULA

**COLOR BLANCO
JANDULA
Y ZAIRE
TARIFA 503**



ZAIRE

**RESTO COLORES
JANDULA
Y ZAIRE
TARIFA 601**

MODELOS LACA



MASSA
(NOVEDAD)

GROSOR 22 MMS
TARIFA BLANCO
601
TARIFA COLORES
602



NANTES
(NOVEDAD)

GROSOR 22 MMS
TARIFA BLANCO
601
TARIFA COLORES
602



ALASKA
(NOVEDAD)

GROSOR 22 MMS
TARIFA BLANCO
601
TARIFA COLORES
602



ANTIQUE
(NOVEDAD)

GROSOR 22 MMS
TARIFA 602



AUSTRAL
(NOVEDAD)

GROSOR 22 MMS
TARIFA BLANCO
602
TARIFA COLORES
612

MODELOS LACA



GROSOR 22 MMS
TARIFA 602

XATIVA



GROSOR 22 MMS
TARIFA 602

DOHA



GROSOR 22 MMS
TARIFA 602

EVEREST



GROSOR 22 MMS
TARIFA 612

GANTE TIRADOR NOGAL



GROSOR 22 MMS
TARIFA 602

VEGA 45°



GROSOR 19 MMS
TARIFA 602

MAELLA

MODELOS MADERA



KENYA
(NOVEDAD)

ROBLE MACIZO
TARIFA 630



ALASKA FRESNO
(NOVEDAD)

FRESNO MACIZO
TARIFA 602



SELENE
(NOVEDAD)

CHAPA ROBLE NUDOS
TARIFA 602

RECOMENDADO PARA
GOLA PLANO



PALMA

CHAPA NOGAL
TARIFA 612

MODELOS MADERA



MARCO ROBLE MACIZO
PLAFON CHAPA ROBLE
TARIFA 601

EBRO



MARCO ROBLE MACIZO
PLAFON CHAPA ROBLE
TARIFA 601

VISTULA



CHAPA ROBLE NUDOS
TARIFA 601

NASI



MARCO FRESNO MACIZO
PLAFON CHAPA FRESNO
TARIFA 600

COLUMBIA



MARCO ROBLE MACIZO
PLAFON CHAPA ROBLE
TARIFA 601

DEVA

CARACTERÍSTICAS TÉCNICAS DE MOBILIARIO

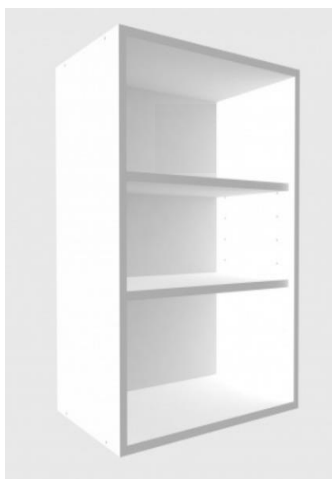

MUEBLE ALTO



MUEBLE BAJO



GRIS



HAYA



NOGAL

STANDARD: Armazón blanco de tablero melamínico acabado soft, grosor 16 mm. Canteado en su totalidad con canto ABS del mismo color. Ensamblado con tornillos o encolado sin incremento de precio. El mueble alto incluye colgador visto montado y el bajo incluye patas.

Acabados disponibles en 16 mm además del blanco, Gris, Haya y Nogal, los cuales llevarán un 4% de incremento sobre el precio del blanco.



Bisagra Sensys HETTICH

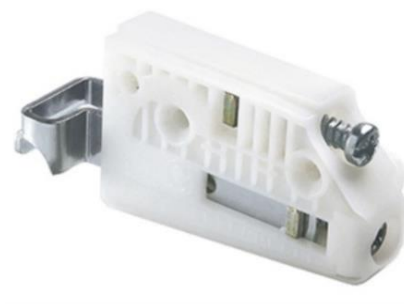

Colgador visto CAMAR + carcasa



Cajón Atira HETTICH

Tanto la bisagra como el cajón de serie son con cierre amortiguado HETTICH



Portaestante módulo 19 mm



Acabado Antracita módulo 19 mm

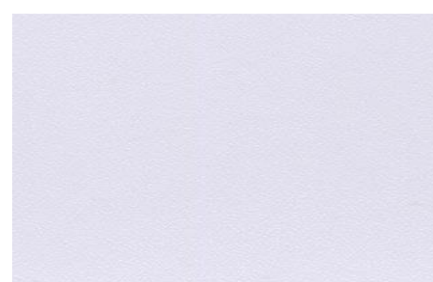

Acabado Blanco módulo 19 mm.

Disponemos de interiores en 19 mm de grosor acabados en Antracita y Blanco. Las baldas de estos interiores van mecanizadas con el portaestante ÚNICO. Estos módulos van encolados de serie salvo que digamos lo contrario.

ALTOS

TARIFA

0 1
INCR. INCR.

| REF. | ANCHO | ALTO | 100 | 200 | 201 | 202 | 300 | 400 | 500 | 503 | 601 | 602 | 612 | 630 | C.19 | |
|------|-------|-------|-----|-----|-----|-----|-----|-----|-----|-----|-----|-----|-----|-----|------|------|
| | | | | | | | | | | | | | | | BL. | ANT. |
| A | 25 | 45 | 57 | 61 | 63 | 65 | 68 | 71 | 79 | 101 | 119 | 130 | 143 | 170 | 10 | 13 |
| A | 30 | | 59 | 63 | 65 | 68 | 71 | 74 | 82 | 102 | 120 | 132 | 145 | 172 | 10 | 13 |
| A | 35 | | 61 | 65 | 67 | 70 | 74 | 77 | 88 | 104 | 124 | 136 | 150 | 177 | 11 | 14 |
| A | 40 | | 64 | 68 | 71 | 74 | 78 | 82 | 94 | 109 | 128 | 141 | 155 | 183 | 11 | 14 |
| A | 45 | | 66 | 70 | 72 | 77 | 81 | 86 | 100 | 115 | 132 | 145 | 160 | 189 | 11 | 14 |
| A | 50 | | 68 | 72 | 75 | 79 | 84 | 89 | 105 | 121 | 137 | 151 | 166 | 196 | 11 | 15 |
| A | 60 | 1P | 73 | 78 | 81 | 86 | 91 | 97 | 118 | 137 | 152 | 167 | 184 | 218 | 12 | 15 |
| REF. | ANCHO | ALTO | | | | | | | | | | | | | | |
| A | 25 | 70 | 72 | 77 | 79 | 82 | 85 | 89 | 100 | 128 | 152 | 167 | 184 | 217 | 11 | 14 |
| A | 30 | | 74 | 79 | 82 | 86 | 89 | 93 | 104 | 129 | 154 | 169 | 186 | 220 | 11 | 14 |
| A | 35 | | 77 | 81 | 84 | 89 | 93 | 97 | 111 | 132 | 159 | 175 | 192 | 227 | 11 | 15 |
| A | 40 | | 80 | 86 | 89 | 94 | 98 | 103 | 119 | 138 | 164 | 180 | 198 | 235 | 12 | 15 |
| A | 45 | | 83 | 88 | 91 | 97 | 102 | 108 | 126 | 146 | 169 | 186 | 204 | 242 | 12 | 15 |
| A | 50 | | 85 | 91 | 94 | 100 | 106 | 112 | 133 | 154 | 176 | 194 | 213 | 252 | 12 | 16 |
| A | 60 | 1P | 92 | 98 | 102 | 109 | 115 | 123 | 149 | 174 | 195 | 215 | 236 | 279 | 13 | 16 |
| REF. | ANCHO | ALTO | | | | | | | | | | | | | | |
| A | 25 | 80/90 | 83 | 88 | 91 | 95 | 99 | 104 | 117 | 158 | 178 | 196 | 215 | 255 | 20 | 24 |
| A | 30 | | 86 | 92 | 95 | 100 | 104 | 109 | 122 | 159 | 180 | 198 | 218 | 257 | 20 | 25 |
| A | 35 | | 89 | 95 | 98 | 103 | 108 | 114 | 131 | 166 | 186 | 205 | 225 | 266 | 20 | 25 |
| A | 40 | | 92 | 98 | 102 | 108 | 114 | 120 | 140 | 174 | 192 | 211 | 232 | 275 | 21 | 25 |
| A | 45 | | 95 | 101 | 105 | 112 | 118 | 126 | 149 | 185 | 198 | 218 | 240 | 283 | 21 | 26 |
| A | 50 | | 100 | 106 | 110 | 117 | 124 | 133 | 159 | 199 | 208 | 229 | 252 | 297 | 21 | 26 |
| A | 60 | 1P | 108 | 114 | 119 | 128 | 136 | 146 | 179 | 214 | 233 | 256 | 282 | 333 | 22 | 27 |
| REF. | ANCHO | ALTO | | | | | | | | | | | | | | |
| A | 25 | 127 | 109 | 116 | 120 | 125 | 130 | 136 | 153 | 207 | 231 | 255 | 280 | 331 | 21 | 26 |
| A | 30 | | 113 | 121 | 125 | 131 | 136 | 143 | 160 | 208 | 234 | 257 | 283 | 335 | 21 | 26 |
| A | 35 | | 117 | 125 | 129 | 135 | 142 | 149 | 172 | 217 | 242 | 266 | 293 | 346 | 22 | 27 |
| A | 40 | | 121 | 129 | 134 | 142 | 149 | 157 | 183 | 227 | 250 | 275 | 302 | 357 | 22 | 27 |
| A | 45 | | 125 | 133 | 138 | 146 | 155 | 165 | 195 | 242 | 257 | 283 | 311 | 368 | 22 | 28 |
| A | 50 | | 131 | 139 | 144 | 153 | 162 | 174 | 208 | 260 | 270 | 297 | 327 | 387 | 23 | 28 |
| A | 60 | 1P | 142 | 149 | 156 | 167 | 178 | 191 | 234 | 279 | 303 | 333 | 367 | 433 | 23 | 29 |
| REF. | ANCHO | ALTO | | | | | | | | | | | | | | |
| A | 25 | 147 | 117 | 124 | 128 | 134 | 139 | 146 | 164 | 222 | 249 | 274 | 302 | 356 | 22 | 27 |
| A | 30 | | 121 | 129 | 134 | 140 | 146 | 153 | 171 | 223 | 252 | 277 | 305 | 360 | 22 | 27 |
| A | 35 | | 125 | 134 | 138 | 145 | 152 | 160 | 184 | 233 | 260 | 286 | 315 | 372 | 22 | 28 |
| A | 40 | | 129 | 138 | 143 | 152 | 160 | 169 | 197 | 244 | 269 | 296 | 325 | 384 | 23 | 28 |
| A | 45 | | 134 | 142 | 148 | 157 | 166 | 177 | 209 | 260 | 277 | 305 | 335 | 396 | 23 | 29 |
| A | 50 | | 141 | 149 | 155 | 164 | 174 | 187 | 223 | 279 | 291 | 320 | 352 | 416 | 23 | 29 |
| A | 60 | 1P | 152 | 160 | 167 | 179 | 191 | 205 | 251 | 300 | 326 | 359 | 395 | 466 | 24 | 30 |

1 PUERTA

| | | | | | | | | | | | | | | | | |
|------|-------|-------|-----|-----|-----|-----|-----|-----|-----|-----|-----|-----|-----|-----|----|----|
| A | 60 | 45 | 88 | 95 | 99 | 104 | 110 | 117 | 134 | 173 | 204 | 225 | 247 | 292 | 12 | 15 |
| A | 70 | | 92 | 99 | 103 | 110 | 117 | 124 | 145 | 178 | 214 | 235 | 259 | 306 | 12 | 16 |
| A | 80 | | 96 | 105 | 110 | 117 | 124 | 133 | 156 | 187 | 222 | 244 | 268 | 317 | 13 | 17 |
| A | 90 | * | 104 | 113 | 117 | 126 | 134 | 143 | 172 | 203 | 233 | 256 | 282 | 333 | 13 | 17 |
| A | 100 | * | 109 | 118 | 123 | 132 | 141 | 152 | 184 | 217 | 245 | 270 | 296 | 350 | 14 | 18 |
| REF. | ANCHO | ALTO | | | | | | | | | | | | | | |
| A | 60 | 70 | 109 | 118 | 123 | 131 | 138 | 146 | 168 | 218 | 262 | 288 | 317 | 375 | 13 | 16 |
| A | 70 | | 114 | 124 | 129 | 138 | 147 | 156 | 183 | 225 | 274 | 301 | 332 | 392 | 13 | 17 |
| A | 80 | | 120 | 131 | 137 | 147 | 156 | 167 | 197 | 236 | 284 | 312 | 344 | 406 | 14 | 18 |
| A | 90 | * | 130 | 141 | 147 | 158 | 168 | 180 | 217 | 257 | 299 | 329 | 362 | 428 | 14 | 19 |
| A | 100 | * | 136 | 148 | 155 | 167 | 178 | 191 | 233 | 275 | 314 | 345 | 380 | 449 | 15 | 19 |
| REF. | ANCHO | ALTO | | | | | | | | | | | | | | |
| A | 60 | 80/90 | 124 | 135 | 141 | 151 | 160 | 170 | 197 | 271 | 306 | 337 | 370 | 438 | 22 | 27 |
| A | 70 | | 131 | 142 | 149 | 160 | 170 | 182 | 216 | 284 | 319 | 351 | 386 | 456 | 23 | 28 |
| A | 80 | | 138 | 151 | 158 | 170 | 182 | 195 | 234 | 302 | 332 | 365 | 402 | 475 | 23 | 29 |
| A | 90 | * | 151 | 163 | 171 | 184 | 197 | 212 | 259 | 331 | 351 | 386 | 425 | 502 | 24 | 30 |
| A | 100 | * | 159 | 171 | 180 | 194 | 208 | 225 | 278 | 357 | 370 | 407 | 448 | 529 | 25 | 31 |
| REF. | ANCHO | ALTO | | | | | | | | | | | | | | |
| A | 60 | 127 | 164 | 178 | 186 | 198 | 210 | 223 | 259 | 355 | 398 | 438 | 481 | 569 | 23 | 29 |
| A | 70 | | 173 | 187 | 196 | 210 | 223 | 239 | 283 | 372 | 415 | 456 | 502 | 593 | 24 | 30 |
| A | 80 | | 182 | 199 | 208 | 223 | 239 | 256 | 307 | 395 | 432 | 475 | 522 | 617 | 25 | 31 |
| A | 90 | * | 199 | 214 | 225 | 242 | 259 | 278 | 339 | 433 | 450 | 495 | 544 | 643 | 25 | 32 |
| A | 100 | * | 209 | 225 | 236 | 255 | 273 | 295 | 364 | 467 | 475 | 522 | 574 | 679 | 26 | 33 |
| REF. | ANCHO | ALTO | | | | | | | | | | | | | | |
| A | 60 | 147 | 175 | 190 | 199 | 212 | 225 | 239 | 277 | 381 | 428 | 471 | 518 | 613 | 24 | 30 |
| A | 70 | | 185 | 200 | 210 | 225 | 239 | 256 | 304 | 399 | 447 | 491 | 540 | 639 | 25 | 31 |
| A | 80 | | 194 | 213 | 222 | 239 | 256 | 274 | 329 | 424 | 465 | 511 | 562 | 665 | 25 | 32 |
| A | 90 | * | 213 | 229 | 241 | 259 | 277 | 298 | 364 | 465 | 484 | 533 | 586 | 693 | 26 | 33 |
| A | 100 | * | 224 | 241 | 253 | 273 | 292 | 316 | 390 | 501 | 511 | 562 | 618 | 731 | 27 | 33 |

2 PUERTAS

* los muebles altos de 90 y 100 de ancho llevan incorporados sistema antipandeo

ALTOS VITRINAS

TARIFA

| REF. | ANCHO | ALTO | LOGIK | EIRE | 500 | 503 | 601 | 602 | 612 | 630 | BL. | ANT. |
|------|-------|-------|-------|------|-----|-----|-----|-----|-----|-----|-----|------|
| | | | AV | 25 | 70 | 150 | 182 | 150 | 171 | 210 | 231 | 254 |
| AV | 30 | | 150 | 182 | 151 | 172 | 212 | 233 | 257 | 303 | 3 | 6 |
| AV | 35 | | 160 | 193 | 162 | 179 | 225 | 248 | 272 | 322 | 3 | 6 |
| AV | 40 | | 170 | 204 | 173 | 190 | 238 | 262 | 288 | 340 | 3 | 6 |
| AV | 45 | | 181 | 216 | 184 | 203 | 250 | 275 | 303 | 358 | 3 | 6 |
| AV | 50 | | 190 | 226 | 197 | 216 | 261 | 287 | 316 | 373 | 4 | 7 |
| AV | 60 | 1P | 209 | 247 | 222 | 245 | 282 | 310 | 341 | 403 | 4 | 7 |
| REF. | ANCHO | ALTO | LOGIK | EIRE | 500 | 503 | 601 | 602 | 612 | 630 | BL. | ANT. |
| AV | 25 | 80/90 | 187 | 223 | 181 | 210 | 255 | 281 | 309 | 365 | 4 | 7 |
| AV | 30 | | 187 | 223 | 183 | 212 | 258 | 284 | 312 | 369 | 4 | 7 |
| AV | 35 | | 201 | 238 | 197 | 223 | 270 | 297 | 327 | 386 | 5 | 8 |
| AV | 40 | | 214 | 252 | 212 | 238 | 285 | 314 | 345 | 408 | 5 | 8 |
| AV | 45 | | 228 | 269 | 226 | 255 | 299 | 329 | 362 | 428 | 5 | 8 |
| AV | 50 | | 241 | 283 | 242 | 274 | 310 | 341 | 375 | 443 | 6 | 9 |
| AV | 60 | 1P | 266 | 309 | 274 | 301 | 340 | 374 | 411 | 486 | 6 | 9 |

1 PUERTA

VITRINAS

| REF. | ANCHO | ALTO | LOGIK | EIRE | 500 | 503 | 601 | 602 | 612 | 630 | BL. | ANT. |
|------|-------|-------|-------|------|-----|-----|-----|-----|-----|-----|-----|------|
| | | | AV | 60 | 70 | 274 | 338 | 258 | 304 | 372 | 409 | 450 |
| AV | 70 | | 296 | 362 | 280 | 319 | 394 | 433 | 477 | 563 | 5 | 8 |
| AV | 80 | | 315 | 383 | 305 | 340 | 418 | 460 | 506 | 598 | 5 | 8 |
| AV | 90 | * | 341 | 411 | 334 | 371 | 446 | 491 | 540 | 638 | 6 | 9 |
| AV | 100 | * | 361 | 433 | 360 | 398 | 468 | 515 | 566 | 669 | 7 | 11 |
| REF. | ANCHO | ALTO | LOGIK | EIRE | 500 | 503 | 601 | 602 | 612 | 630 | BL. | ANT. |
| AV | 60 | 80/90 | 337 | 409 | 318 | 376 | 452 | 497 | 547 | 646 | 6 | 9 |
| AV | 70 | | 365 | 439 | 347 | 400 | 476 | 524 | 576 | 681 | 6 | 9 |
| AV | 80 | | 392 | 468 | 378 | 430 | 502 | 552 | 607 | 718 | 7 | 11 |
| AV | 90 | * | 425 | 507 | 414 | 471 | 535 | 589 | 647 | 765 | 7 | 11 |
| AV | 100 | * | 455 | 539 | 444 | 508 | 564 | 620 | 682 | 807 | 8 | 12 |

2 PUERTAS

* los muebles altos de 90 y 100 de ancho llevan incorporados sistema antipandeo

VITRINAS DE ALUMINIO



MODELO LOGIK

TIRADOR LOGIK



- 3640 ALUMINIO
- 3641 NEGRO
- 3642 ANTRACITA



MODELO EIRE



MODELO ZEN

LOGIK : ACABADOS ALUMINIO, NEGRO Y ANTRACITA.
PRECIO IGUAL PARA TODOS LOS ACABADOS.

EIRE: ACABADOS CROMO BRILLO, COBRE Y ANTRACITA.
PRECIO IGUAL PARA TODOS LOS ACABADOS.

ZEN: ACABADOS NEGRO Y ANTRACITA.
PRECIO IGUAL PARA TODOS LOS ACABADOS,
PARA PEDIDOS UTILIZAREMOS EL MISMO
CÓDIGO DE EIRE ESPECIFICANDO MODELO ZEN

LAS VITRINAS DE ALUMINIO LLEVAN INCLUIDO EL PRECIO DEL TIRADOR DE SERIE.

CRISTALES DISPONIBLES: SATENGLAS, TRANSPARENTE, GÓTICO, TELA, PARSOL GRIS, PARSOL BRONCE LACADO EXTRA BLANCO, LACADO NEGRO Y LACADO MOKA.

**ALTOS
PUERTA ABATIBLE
PISTON GAS**

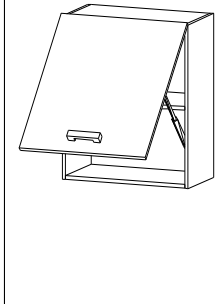

| REF. | ANCHO | ALTO | TARIFA | | | | | | | | | | | | 0 | 1 | | |
|------|-------|------|--------|------|-----|-----|-----|-----|-----|-----|-----|-----|-----|-----|-------|-------|------|------|
| | | | 100 | 200 | 201 | 202 | 300 | 400 | 500 | 503 | 601 | 602 | 612 | 630 | INCR. | INCR. | | |
| | | | BL. | ANT. | | | | | | | | | | | | | C.19 | C.19 |
| AB | 45 | 35 | 87 | 91 | 93 | 96 | 99 | 102 | 109 | 124 | 176 | 194 | 213 | 252 | 3 | 6 | | |
| AB | 50 | | 90 | 95 | 97 | 100 | 103 | 107 | 115 | 132 | 180 | 198 | 218 | 257 | 3 | 6 | | |
| AB | 60 | | 95 | 99 | 102 | 106 | 109 | 113 | 124 | 143 | 188 | 207 | 227 | 269 | 4 | 7 | | |
| AB | 70 | | 113 | 118 | 121 | 125 | 129 | 134 | 147 | 169 | 194 | 213 | 235 | 277 | 4 | 7 | | |
| AB | 80 | | 121 | 127 | 131 | 137 | 143 | 150 | 169 | 203 | 218 | 240 | 264 | 312 | 5 | 8 | | |
| AB | 90 | * | 129 | 135 | 139 | 145 | 151 | 158 | 177 | 233 | 267 | 294 | 323 | 382 | 5 | 8 | | |
| AB | 100 | * | 138 | 144 | 149 | 155 | 162 | 169 | 189 | 249 | 286 | 314 | 346 | 409 | | | | |
| REF. | ANCHO | ALTO | | | | | | | | | | | | | | | | |
| AB | 45 | 45 | 92 | 96 | 98 | 102 | 105 | 108 | 117 | 133 | 190 | 209 | 230 | 272 | 3 | 6 | | |
| AB | 50 | | 95 | 100 | 106 | 108 | 110 | 113 | 122 | 142 | 194 | 213 | 235 | 277 | 3 | 6 | | |
| AB | 60 | | 100 | 106 | 108 | 112 | 116 | 121 | 132 | 154 | 204 | 224 | 247 | 292 | 4 | 7 | | |
| AB | 70 | | 119 | 124 | 127 | 132 | 137 | 142 | 157 | 180 | 219 | 241 | 265 | 313 | 4 | 7 | | |
| AB | 80 | | 128 | 135 | 139 | 146 | 152 | 159 | 181 | 218 | 245 | 270 | 296 | 350 | 5 | 8 | | |
| AB | 90 | * | 136 | 143 | 147 | 154 | 161 | 168 | 189 | 233 | 267 | 294 | 323 | 382 | 5 | 8 | | |
| AB | 100 | * | 146 | 153 | 157 | 165 | 172 | 180 | 202 | 249 | 286 | 314 | 346 | 409 | | | | |
| REF. | ANCHO | ALTO | | | | | | | | | | | | | | | | |
| AB | 45 | 60 | 110 | 115 | 118 | 122 | 126 | 130 | 140 | 160 | 228 | 251 | 276 | 326 | 3 | 6 | | |
| AB | 50 | | 114 | 120 | 127 | 130 | 132 | 136 | 146 | 170 | 233 | 256 | 282 | 333 | 3 | 6 | | |
| AB | 60 | | 120 | 127 | 130 | 134 | 139 | 145 | 158 | 185 | 245 | 269 | 296 | 350 | 4 | 7 | | |
| AB | 70 | | 143 | 149 | 152 | 158 | 164 | 170 | 188 | 216 | 263 | 289 | 318 | 376 | 4 | 7 | | |
| AB | 80 | | 154 | 162 | 167 | 175 | 182 | 191 | 217 | 262 | 294 | 323 | 356 | 420 | 5 | 8 | | |
| AB | 90 | * | 163 | 172 | 176 | 185 | 193 | 202 | 227 | 280 | 320 | 352 | 388 | 458 | 5 | 8 | | |
| AB | 100 | * | 175 | 184 | 189 | 198 | 207 | 216 | 243 | 299 | 343 | 377 | 415 | 490 | | | | |

**VITRINA ABATIBLE
PISTON GAS**

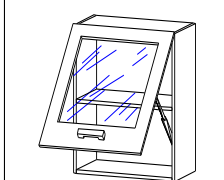

| REF. | ANCHO | ALTO | TARIFA | | | | | | | | | | | | BL. | ANT. |
|------|-------|------|--------|------|-----|-----|-----|-----|-----|-----|---|---|--|--|-----|------|
| | | | LOGIK | EIRE | 500 | 503 | 601 | 602 | 612 | 630 | | | | | | |
| ABV | 45 | 35 | 163 | 188 | 193 | 212 | 258 | 284 | 312 | 369 | 3 | 6 | | | | |
| ABV | 50 | | 168 | 195 | 206 | 225 | 268 | 295 | 324 | 383 | 3 | 6 | | | | |
| ABV | 60 | | 193 | 225 | 244 | 268 | 313 | 344 | 379 | 448 | 4 | 7 | | | | |
| ABV | 70 | | 207 | 242 | 255 | 280 | 323 | 355 | 391 | 462 | 4 | 7 | | | | |
| ABV | 80 | | 217 | 255 | 269 | 300 | 347 | 382 | 420 | 496 | 5 | 8 | | | | |
| ABV | 90 | * | 231 | 273 | 283 | 316 | 365 | 402 | 442 | 522 | 5 | 8 | | | | |
| ABV | 100 | * | 247 | 292 | 303 | 338 | 391 | 430 | 473 | 558 | 6 | 9 | | | | |
| REF. | ANCHO | ALTO | | | | | | | | | | | | | | |
| ABV | 45 | 45 | 172 | 204 | 197 | 215 | 260 | 286 | 315 | 372 | 3 | 6 | | | | |
| ABV | 50 | | 181 | 211 | 210 | 229 | 273 | 300 | 330 | 390 | 3 | 6 | | | | |
| ABV | 60 | | 205 | 242 | 249 | 272 | 319 | 351 | 386 | 456 | 4 | 7 | | | | |
| ABV | 70 | | 222 | 261 | 260 | 284 | 339 | 363 | 389 | 462 | 4 | 7 | | | | |
| ABV | 80 | | 235 | 276 | 274 | 305 | 354 | 389 | 428 | 506 | 5 | 8 | | | | |
| ABV | 90 | * | 248 | 292 | 288 | 321 | 375 | 413 | 454 | 536 | 5 | 8 | | | | |
| ABV | 100 | * | 265 | 312 | 308 | 343 | 401 | 441 | 486 | 574 | 6 | 9 | | | | |
| REF. | ANCHO | ALTO | | | | | | | | | | | | | | |
| ABV | 45 | 60 | 206 | 245 | 236 | 258 | 312 | 343 | 378 | 446 | 3 | 6 | | | | |
| ABV | 50 | | 217 | 253 | 252 | 275 | 328 | 360 | 396 | 468 | 3 | 6 | | | | |
| ABV | 60 | | 246 | 290 | 299 | 326 | 383 | 421 | 463 | 547 | 4 | 7 | | | | |
| ABV | 70 | | 266 | 313 | 312 | 341 | 387 | 425 | 467 | 554 | 4 | 7 | | | | |
| ABV | 80 | | 282 | 331 | 329 | 366 | 425 | 467 | 514 | 607 | 5 | 8 | | | | |
| ABV | 90 | * | 298 | 350 | 346 | 385 | 450 | 495 | 545 | 644 | 5 | 8 | | | | |
| ABV | 100 | * | 318 | 375 | 370 | 412 | 482 | 530 | 583 | 689 | 6 | 9 | | | | |

**PUERTA ABATIBLE
HK BLUM**

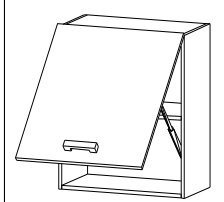

| REF. | ANCHO | ALTO | TARIFA | | | | | | | | | | | | BL. | ANT. |
|------|-------|------|--------|-----|-----|-----|-----|-----|-----|-----|-----|-----|-----|-----|-----|------|
| | | | 100 | 200 | 201 | 202 | 300 | 400 | 500 | 503 | 601 | 602 | 612 | 630 | | |
| ABHK | 45 | 35 | 137 | 141 | 143 | 146 | 149 | 152 | 159 | 174 | 226 | 244 | 268 | 317 | 3 | 6 |
| ABHK | 50 | | 140 | 145 | 147 | 150 | 153 | 157 | 165 | 182 | 230 | 248 | 273 | 322 | 3 | 6 |
| ABHK | 60 | | 145 | 149 | 152 | 156 | 159 | 163 | 174 | 193 | 238 | 257 | 282 | 334 | 4 | 7 |
| ABHK | 70 | | 163 | 168 | 171 | 175 | 179 | 184 | 197 | 219 | 244 | 263 | 290 | 342 | 4 | 7 |
| ABHK | 80 | | 171 | 177 | 181 | 187 | 193 | 200 | 219 | 253 | 268 | 290 | 319 | 377 | 5 | 8 |
| ABHK | 90 | * | 179 | 185 | 189 | 195 | 201 | 208 | 227 | 283 | 317 | 344 | 378 | 447 | 5 | 8 |
| ABHK | 100 | * | 188 | 194 | 199 | 205 | 212 | 219 | 239 | 299 | 336 | 364 | 401 | 474 | 6 | 9 |
| REF. | ANCHO | ALTO | | | | | | | | | | | | | | |
| ABHK | 45 | 45 | 142 | 146 | 148 | 152 | 155 | 158 | 167 | 183 | 240 | 259 | 285 | 337 | 3 | 6 |
| ABHK | 50 | | 145 | 150 | 156 | 158 | 160 | 163 | 172 | 192 | 244 | 263 | 290 | 342 | 3 | 6 |
| ABHK | 60 | | 150 | 156 | 158 | 162 | 166 | 171 | 182 | 204 | 254 | 274 | 302 | 357 | 4 | 7 |
| ABHK | 70 | | 169 | 174 | 177 | 182 | 187 | 192 | 207 | 230 | 269 | 291 | 320 | 378 | 4 | 7 |
| ABHK | 80 | | 178 | 185 | 189 | 196 | 202 | 209 | 231 | 268 | 295 | 320 | 351 | 415 | 5 | 8 |
| ABHK | 90 | * | 186 | 193 | 197 | 204 | 211 | 218 | 239 | 283 | 317 | 344 | 378 | 447 | 5 | 8 |
| ABHK | 100 | * | 196 | 203 | 207 | 215 | 222 | 230 | 252 | 299 | 336 | 364 | 401 | 474 | 6 | 9 |
| REF. | ANCHO | ALTO | | | | | | | | | | | | | | |
| ABHK | 45 | 60 | 160 | 165 | 168 | 172 | 176 | 180 | 190 | 210 | 278 | 301 | 331 | 391 | 3 | 6 |
| ABHK | 50 | | 164 | 170 | 177 | 180 | 182 | 186 | 196 | 220 | 283 | 306 | 337 | 398 | 3 | 6 |
| ABHK | 60 | | 170 | 177 | 180 | 184 | 189 | 195 | 208 | 235 | 295 | 319 | 351 | 415 | 4 | 7 |
| ABHK | 70 | | 193 | 199 | 202 | 208 | 214 | 220 | 238 | 266 | 313 | 339 | 373 | 441 | 4 | 7 |
| ABHK | 80 | | 204 | 212 | 217 | 225 | 232 | 241 | 267 | 312 | 344 | 373 | 411 | 485 | 5 | 8 |
| ABHK | 90 | * | 213 | 222 | 226 | 235 | 243 | 252 | 277 | 330 | 370 | 402 | 443 | 523 | 5 | 8 |
| ABHK | 100 | * | 225 | 234 | 239 | 248 | 257 | 266 | 293 | 349 | 393 | 427 | 470 | 555 | 6 | 9 |

VITRINA ABATIBLE
HK BLUM

| REF. | ANCHO | ALTO | LOGIK | EIRE | 500 | 503 | 601 | 602 | 612 | 630 | INCR. INCR. | | | |
|-------|-------|------|----------------------|------|-----|-----|-----|-----|-----|-----|-------------|------|---|---|
| | | | | | | | | | | | C.19 | C.19 | | |
| ABVHK | 45 | 35 | | | 213 | 238 | 243 | 262 | 308 | 334 | 367 | 434 | 3 | 6 |
| ABVHK | 50 | | | | 218 | 245 | 256 | 275 | 318 | 345 | 379 | 448 | 3 | 6 |
| ABVHK | 60 | | CODIGO VITRINA LOGIK | | 243 | 275 | 294 | 318 | 363 | 394 | 434 | 513 | 4 | 7 |
| ABVHK | 70 | | 100ABVA | | 257 | 292 | 305 | 330 | 373 | 405 | 446 | 527 | 4 | 7 |
| ABVHK | 80 | | | | 267 | 305 | 319 | 350 | 397 | 432 | 475 | 561 | 5 | 8 |
| ABVHK | 90 | * | | | 281 | 323 | 333 | 366 | 415 | 452 | 497 | 587 | 5 | 8 |
| ABVHK | 100 | * | | | 297 | 342 | 353 | 388 | 441 | 480 | 528 | 623 | 6 | 9 |
| REF. | ANCHO | ALTO | | | | | | | | | | | | |
| ABVHK | 45 | 45 | | | 222 | 254 | 247 | 265 | 310 | 336 | 370 | 437 | 3 | 6 |
| ABVHK | 50 | | CODIGO VITRINA EIRE | | 231 | 261 | 260 | 279 | 323 | 350 | 385 | 455 | 3 | 6 |
| ABVHK | 60 | | 100ABVAE | | 255 | 292 | 299 | 322 | 369 | 401 | 441 | 521 | 4 | 7 |
| ABVHK | 70 | | | | 272 | 311 | 310 | 334 | 289 | 313 | 344 | 407 | 4 | 7 |
| ABVHK | 80 | | | | 285 | 326 | 324 | 355 | 404 | 439 | 483 | 571 | 5 | 8 |
| ABVHK | 90 | * | | | 298 | 342 | 338 | 371 | 425 | 463 | 509 | 601 | 5 | 8 |
| ABVHK | 100 | * | | | 315 | 362 | 358 | 393 | 451 | 491 | 541 | 639 | 6 | 9 |
| REF. | ANCHO | ALTO | | | | | | | | | | | | |
| ABVHK | 45 | 60 | | | 256 | 295 | 286 | 308 | 362 | 393 | 433 | 511 | 3 | 6 |
| ABVHK | 50 | | CODIGO VITRINA ZEN | | 267 | 303 | 302 | 325 | 378 | 410 | 451 | 533 | 3 | 6 |
| ABVHK | 60 | | 100ABVAE | | 296 | 340 | 349 | 376 | 433 | 471 | 518 | 612 | 4 | 7 |
| ABVHK | 70 | | | | 316 | 363 | 362 | 391 | 337 | 365 | 402 | 475 | 4 | 7 |
| ABVHK | 80 | | | | 332 | 381 | 379 | 416 | 475 | 517 | 569 | 672 | 5 | 8 |
| ABVHK | 90 | * | | | 348 | 400 | 396 | 435 | 500 | 545 | 600 | 709 | 5 | 8 |
| ABVHK | 100 | * | | | 368 | 425 | 420 | 462 | 532 | 580 | 638 | 754 | 6 | 9 |

ESCURREPLATOS

| REF. | ANCHO | ALTO | 100 | 200 | 201 | 202 | 300 | 400 | 500 | 503 | 601 | 602 | 612 | 630 | BL. ANT. | |
|------|-------|-------|-----|-----|-----|-----|-----|-----|-----|-----|-----|-----|-----|-----|----------|------|
| | | | | | | | | | | | | | | | BL. | ANT. |
| ES | 40 | 70 | 89 | 94 | 97 | 102 | 107 | 112 | 127 | 146 | 172 | 189 | 208 | 246 | 2 | 5 |
| ES | 45 | | 93 | 98 | 101 | 107 | 112 | 118 | 136 | 156 | 178 | 196 | 215 | 255 | 2 | 5 |
| ES | 50 | | 98 | 104 | 107 | 113 | 119 | 126 | 146 | 167 | 188 | 207 | 227 | 269 | 3 | 6 |
| ES | 60 | 1P | 105 | 111 | 115 | 122 | 128 | 136 | 162 | 187 | 207 | 228 | 250 | 296 | 3 | 6 |
| REF. | ANCHO | ALTO | | | | | | | | | | | | | | |
| ES | 40 | 80/90 | 101 | 107 | 111 | 117 | 123 | 130 | 149 | 183 | 200 | 220 | 242 | 286 | 4 | 7 |
| ES | 45 | | 106 | 112 | 116 | 123 | 129 | 136 | 160 | 196 | 208 | 229 | 252 | 297 | 4 | 7 |
| ES | 50 | | 112 | 119 | 123 | 130 | 137 | 146 | 172 | 211 | 220 | 242 | 266 | 315 | 5 | 8 |
| ES | 60 | 1P | 120 | 127 | 132 | 140 | 148 | 158 | 192 | 226 | 244 | 268 | 295 | 349 | 5 | 8 |

1 PUERTA

| REF. | ANCHO | ALTO | 100 | 200 | 201 | 202 | 300 | 400 | 500 | 503 | 601 | 602 | 612 | 630 | BL. ANT. | |
|------|-------|-------|-----|-----|-----|-----|-----|-----|-----|-----|-----|-----|-----|-----|----------|------|
| | | | | | | | | | | | | | | | BL. | ANT. |
| ES | 60 | 70 | 119 | 129 | 133 | 141 | 149 | 157 | 178 | 228 | 271 | 298 | 328 | 388 | 3 | 6 |
| ES | 70 | | 125 | 135 | 140 | 149 | 157 | 166 | 193 | 236 | 282 | 310 | 341 | 403 | 4 | 7 |
| ES | 80 | | 131 | 141 | 147 | 157 | 166 | 177 | 207 | 246 | 292 | 321 | 353 | 418 | 4 | 7 |
| ES | 90 | | 135 | 146 | 152 | 163 | 173 | 185 | 222 | 262 | 302 | 332 | 365 | 432 | 5 | 8 |
| REF. | ANCHO | ALTO | | | | | | | | | | | | | | |
| ES | 60 | 80/90 | 135 | 147 | 152 | 162 | 171 | 182 | 208 | 282 | 315 | 347 | 381 | 450 | 5 | 8 |
| ES | 70 | | 142 | 154 | 160 | 171 | 182 | 193 | 227 | 296 | 328 | 361 | 397 | 469 | 5 | 8 |
| ES | 80 | | 149 | 162 | 169 | 181 | 193 | 206 | 246 | 313 | 341 | 375 | 413 | 488 | 6 | 10 |
| ES | 90 | | 156 | 168 | 176 | 189 | 202 | 217 | 263 | 336 | 356 | 392 | 431 | 509 | 6 | 10 |

2 PUERTAS

| | | |
|-----|----|----|
| IBE | 40 | 7 |
| IBE | 45 | 7 |
| IBE | 50 | 8 |
| IBE | 60 | 9 |
| IBE | 70 | 10 |
| IBE | 80 | 12 |
| IBE | 90 | 13 |

INCREMENTO BANDEJA ESCURREPLATOS

| | | |
|--|----|----|
| | 40 | 27 |
| | 45 | 30 |
| | 50 | 31 |
| | 60 | 32 |
| | 70 | 34 |
| | 80 | 39 |
| | 90 | 41 |

INCREMENTO BANDEJA ESCURREPLATOS INOX

TERMINAL

| REF. | ANCHO | ALTO | 100 | 200 | 201 | 202 | 300 | 400 | 500 | 503 | 601 | 602 | 612 | 630 |
|------|-------|-------|-----|-----|-----|-----|-----|-----|-----|-----|-----|-----|-----|-----|
| | | | | | | | | | | | | | | |
| TC | 33 | 80/90 | 88 | 99 | 107 | 119 | 131 | 150 | 173 | 196 | 189 | 207 | 228 | 228 |
| REF. | ANCHO | ALTO | | | | | | | | | | | | |
| TCP | 33 | 70 | 128 | 143 | 158 | 165 | 171 | 183 | 204 | 269 | 353 | 388 | 427 | 505 |
| TCP | 33 | 80/90 | 166 | 186 | 205 | 214 | 222 | 238 | 265 | 350 | 459 | 505 | 555 | 656 |

ESTANTES

| REF. | ANCHO | ALTO | 100 | 200 | 201 | 202 | 300 | 400 | 500 | 503 | 601 | 602 | 612 | 630 |
|------|-------|-------|-----|-----|-----|-----|-----|-----|-----|-----|-----|-----|-----|-----|
| | | | | | | | | | | | | | | |
| AE | 45 | | 86 | 97 | 105 | 107 | 108 | 115 | 124 | 147 | 140 | 154 | 154 | 154 |
| AE | 60 | | 109 | 122 | 133 | 134 | 136 | 145 | 156 | 185 | 177 | 194 | 194 | 194 |
| REF. | ANCHO | ALTO | | | | | | | | | | | | |
| AE | 30 | 80/90 | 80 | 90 | 98 | 99 | 100 | 106 | 115 | 136 | 130 | 143 | 143 | 143 |
| AE | 45 | | 108 | 121 | 132 | 133 | 135 | 143 | 155 | 184 | 176 | 193 | 193 | 193 |
| AE | 60 | | 136 | 152 | 166 | 168 | 170 | 181 | 196 | 232 | 221 | 243 | 243 | 243 |

BOTELLEROS

| REF. | ANCHO | ALTO | 100 | 200 | 201 | 202 | 300 | 400 | 500 | 503 | 601 | 602 | 612 | 630 |
|------|-------|-------|-----|-----|-----|-----|-----|-----|-----|-----|-----|-----|-----|-----|
| | | | | | | | | | | | | | | |
| BOT | 30 | | 89 | 100 | 106 | 110 | 114 | 120 | 141 | 150 | 162 | 178 | 148 | 178 |
| BOT | 45 | | 116 | 130 | 138 | 143 | 148 | 156 | 183 | 195 | 211 | 232 | 232 | 232 |
| REF. | ANCHO | ALTO | | | | | | | | | | | | |
| BOT | 15 | 80/90 | 89 | 100 | 106 | 110 | 114 | 120 | 141 | 150 | 162 | 178 | 178 | 178 |
| BOT | 30 | | 111 | 125 | 133 | 138 | 143 | 150 | 176 | 188 | 203 | 223 | 223 | 223 |
| BOT | 45 | | 145 | 162 | 172 | 179 | 185 | 195 | 229 | 244 | 263 | 290 | 290 | 290 |

ALTOS

ALTO MICROONDAS
FONDO 33 cm

TARIFA

INCR. INCR.
C.19 C.19

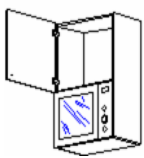
| REF. | ANCHO | ALTO | 100 | 200 | 201 | 202 | 300 | 400 | 500 | 503 | 601 | 602 | 612 | 630 | BL. | ANT. |
|---|-------|----------|-----|-----|-----|-----|-----|-----|-----|-----|-----|-----|-----|-----|------|------|
| | | | | | | | | | | | | | | | C.19 | C.19 |
|  AM | 60 | 80/90 1P | 108 | 114 | 119 | 128 | 136 | 146 | 179 | 214 | 233 | 256 | 282 | 333 | 22 | 27 |
| AM | 60 | 110 1P | 134 | 141 | 147 | 158 | 169 | 181 | 222 | 266 | 291 | 320 | 352 | 416 | 23 | 29 |

1 PUERTA

2 PUERTAS

ALTOS
SOBREFRIGO

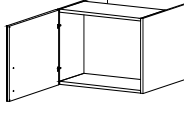
| REF. | ANCHO | ALTO | 100 | 200 | 201 | 202 | 300 | 400 | 500 | 503 | 601 | 602 | 612 | 630 | BL. | ANT. |
|--|-------|-------|-----|-----|-----|-----|-----|-----|-----|-----|-----|-----|-----|-----|------|------|
| | | | | | | | | | | | | | | | C.19 | C.19 |
|  ASF | 60 | 42 1P | 103 | 108 | 111 | 116 | 121 | 127 | 148 | 167 | 182 | 200 | 220 | 260 | 15 | 21 |
| ASF | 60 | 50 1P | 128 | 134 | 138 | 145 | 151 | 159 | 185 | 210 | 225 | 248 | 272 | 322 | 15 | 21 |
| ASF | 60 | 55 1P | 122 | 128 | 132 | 139 | 145 | 153 | 179 | 204 | 225 | 248 | 272 | 322 | 15 | 21 |
| ASF | 60 | 60 1P | 122 | 128 | 132 | 139 | 145 | 153 | 179 | 204 | 225 | 248 | 272 | 322 | 16 | 22 |
| ASF | 60 | 70 1P | 122 | 128 | 132 | 139 | 145 | 153 | 179 | 204 | 225 | 248 | 272 | 322 | 16 | 22 |

1 PUERTA

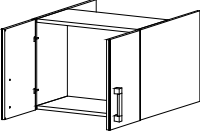
| REF. | ANCHO | ALTO | 100 | 200 | 201 | 202 | 300 | 400 | 500 | 503 | 601 | 602 | 612 | 630 | BL. | ANT. |
|--|-------|------|-----|-----|-----|-----|-----|-----|-----|-----|-----|-----|-----|-----|------|------|
| | | | | | | | | | | | | | | | C.19 | C.19 |
|  ASF | 60 | 25 | 118 | 125 | 129 | 135 | 140 | 147 | 164 | 203 | 234 | 257 | 283 | 335 | 5 | 8 |
| ASF | 60 | 30 | 118 | 125 | 129 | 134 | 140 | 147 | 164 | 203 | 234 | 258 | 284 | 335 | 5 | 8 |
| ASF | 60 | 35 | 118 | 125 | 129 | 135 | 140 | 147 | 164 | 203 | 234 | 258 | 284 | 335 | 5 | 8 |
| ASF | 60 | 42 | 118 | 125 | 129 | 135 | 140 | 147 | 164 | 203 | 234 | 258 | 284 | 335 | 15 | 21 |
| ASF | 60 | 50 | 139 | 148 | 153 | 161 | 168 | 176 | 198 | 248 | 292 | 321 | 353 | 418 | 15 | 21 |
| ASF | 60 | 55 | 139 | 148 | 153 | 161 | 168 | 176 | 198 | 248 | 292 | 321 | 353 | 418 | 15 | 21 |
| ASF | 60 | 60 | 139 | 148 | 153 | 161 | 168 | 176 | 198 | 248 | 292 | 321 | 353 | 418 | 16 | 22 |
| ASF | 60 | 70 | 139 | 148 | 153 | 161 | 168 | 176 | 198 | 248 | 292 | 321 | 353 | 418 | 16 | 22 |

2 PUERTAS

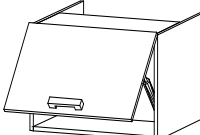
| REF. | ANCHO | ALTO | 100 | 200 | 201 | 202 | 300 | 400 | 500 | 503 | 601 | 602 | 612 | 630 | BL. | ANT. |
|---|-------|------|-----|-----|-----|-----|-----|-----|-----|-----|-----|-----|-----|-----|------|------|
| | | | | | | | | | | | | | | | C.19 | C.19 |
|  ABSF | 60 | 25 | 127 | 132 | 135 | 140 | 145 | 151 | 172 | 191 | 212 | 233 | 257 | 303 | 5 | 8 |
| ABSF | 60 | 30 | 127 | 132 | 135 | 140 | 145 | 151 | 172 | 191 | 212 | 233 | 257 | 303 | 5 | 8 |
| ABSF | 60 | 35 | 127 | 132 | 135 | 140 | 145 | 151 | 172 | 191 | 212 | 233 | 257 | 303 | 5 | 8 |
| ABSF | 60 | 42 | 127 | 132 | 135 | 140 | 145 | 151 | 172 | 191 | 212 | 233 | 257 | 303 | 15 | 21 |
| ABSF | 60 | 50 | 146 | 152 | 156 | 163 | 169 | 177 | 203 | 228 | 255 | 281 | 309 | 365 | 15 | 21 |
| ABSF | 60 | 55 | 146 | 152 | 156 | 163 | 169 | 177 | 203 | 228 | 255 | 281 | 309 | 365 | 15 | 21 |
| ABSF | 60 | 60 | 146 | 152 | 156 | 163 | 169 | 177 | 203 | 228 | 255 | 281 | 309 | 365 | 16 | 22 |
| ABSF | 60 | 70 | 146 | 152 | 156 | 163 | 169 | 177 | 203 | 228 | 255 | 281 | 309 | 365 | 16 | 22 |

ABATIBLE

PISTON DE GAS

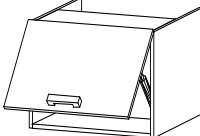
| REF. | ANCHO | ALTO | 100 | 200 | 201 | 202 | 300 | 400 | 500 | 503 | 601 | 602 | 612 | 630 | BL. | ANT. |
|---|-------|------|-----|-----|-----|-----|-----|-----|-----|-----|-----|-----|-----|-----|------|------|
| | | | | | | | | | | | | | | | C.19 | C.19 |
|  ABSFHK | 60 | 25 | 186 | 191 | 194 | 199 | 204 | 210 | 231 | 250 | 271 | 298 | 328 | 388 | 5 | 8 |
| ABSFHK | 60 | 30 | 186 | 191 | 194 | 199 | 204 | 210 | 231 | 250 | 271 | 298 | 328 | 388 | 5 | 8 |
| ABSFHK | 60 | 35 | 186 | 191 | 194 | 199 | 204 | 210 | 231 | 250 | 271 | 298 | 328 | 388 | 5 | 8 |
| ABSFHK | 60 | 42 | 186 | 191 | 194 | 199 | 204 | 210 | 231 | 250 | 271 | 298 | 328 | 388 | 15 | 21 |
| ABSFHK | 60 | 50 | 232 | 238 | 242 | 249 | 255 | 263 | 289 | 314 | 341 | 375 | 413 | 488 | 15 | 21 |
| ABSFHK | 60 | 55 | 232 | 238 | 242 | 249 | 255 | 263 | 289 | 314 | 341 | 375 | 413 | 488 | 15 | 21 |
| ABSFHK | 60 | 60 | 232 | 238 | 242 | 249 | 255 | 263 | 289 | 314 | 341 | 375 | 413 | 488 | 16 | 22 |
| ABSFHK | 60 | 70 | 232 | 238 | 242 | 249 | 255 | 263 | 289 | 314 | 341 | 375 | 413 | 488 | 16 | 22 |

ABATIBLE

CON HK BLUM

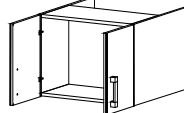
| REF. | ANCHO | ALTO | 100 | 200 | 201 | 202 | 300 | 400 | 500 | 503 | 601 | 602 | 612 | 630 | BL. | ANT. |
|--|-------|------|-----|-----|-----|-----|-----|-----|-----|-----|-----|-----|-----|-----|------|------|
| | | | | | | | | | | | | | | | C.19 | C.19 |
|  ASF | 92 | 30 | 153 | 162 | 167 | 175 | 182 | 190 | 213 | 263 | 305 | 335 | 369 | 436 | 7 | 11 |
| ASF | 92 | 35 | 153 | 163 | 168 | 175 | 182 | 191 | 213 | 264 | 304 | 335 | 369 | 436 | 7 | 11 |
| ASF | 92 | 42 | 153 | 163 | 168 | 175 | 182 | 191 | 213 | 264 | 305 | 335 | 369 | 436 | 19 | 27 |
| ASF | 92 | 50 | 181 | 192 | 199 | 209 | 218 | 229 | 257 | 322 | 380 | 418 | 459 | 543 | 19 | 27 |
| ASF | 92 | 55 | 181 | 192 | 199 | 209 | 218 | 229 | 257 | 322 | 380 | 418 | 459 | 543 | 19 | 27 |

2 PUERTAS

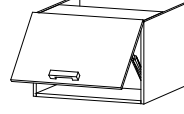
| REF. | ANCHO | ALTO | 100 | 200 | 201 | 202 | 300 | 400 | 500 | 503 | 601 | 602 | 612 | 630 | BL. | ANT. |
|---|-------|------|-----|-----|-----|-----|-----|-----|-----|-----|-----|-----|-----|-----|------|------|
| | | | | | | | | | | | | | | | C.19 | C.19 |
|  ABSF | 92 | 30 | 165 | 172 | 176 | 182 | 189 | 196 | 224 | 248 | 276 | 303 | 334 | 394 | 7 | 11 |
| ABSF | 92 | 35 | 165 | 172 | 176 | 182 | 189 | 196 | 224 | 248 | 276 | 303 | 334 | 394 | 7 | 11 |
| ABSF | 92 | 42 | 165 | 172 | 176 | 182 | 189 | 196 | 224 | 248 | 276 | 303 | 334 | 394 | 19 | 27 |
| ABSF | 92 | 50 | 190 | 198 | 203 | 211 | 220 | 230 | 264 | 296 | 332 | 365 | 401 | 474 | 19 | 27 |
| ABSF | 92 | 55 | 190 | 198 | 203 | 211 | 220 | 230 | 264 | 296 | 332 | 365 | 401 | 474 | 19 | 27 |

ABATIBLE

PISTON DE GAS

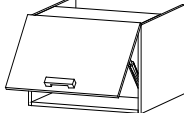
| REF. | ANCHO | ALTO | 100 | 200 | 201 | 202 | 300 | 400 | 500 | 503 | 601 | 602 | 612 | 630 | BL. | ANT. |
|---|-------|------|-----|-----|-----|-----|-----|-----|-----|-----|-----|-----|-----|-----|------|------|
| | | | | | | | | | | | | | | | C.19 | C.19 |
|  ABSFHK | 92 | 30 | 223 | 229 | 233 | 239 | 245 | 252 | 277 | 300 | 325 | 358 | 394 | 465 | 7 | 11 |
| ABSFHK | 92 | 35 | 223 | 229 | 233 | 239 | 245 | 252 | 277 | 300 | 325 | 358 | 394 | 465 | 7 | 11 |
| ABSFHK | 92 | 42 | 223 | 229 | 233 | 239 | 245 | 252 | 277 | 300 | 325 | 358 | 394 | 465 | 19 | 27 |
| ABSFHK | 92 | 50 | 278 | 286 | 290 | 298 | 306 | 316 | 347 | 377 | 409 | 450 | 495 | 585 | 19 | 27 |
| ABSFHK | 92 | 55 | 278 | 286 | 290 | 298 | 306 | 316 | 347 | 377 | 409 | 450 | 495 | 585 | 19 | 27 |

ABATIBLE

CON HK BLUM

ALTOS

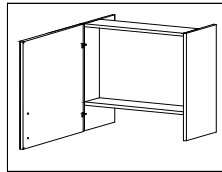
CAMPANAS
EXTRAPLANAS

1 PUERTA

| REF. | ANCHO | ALTO | TARIFA | | | | | | | | | | | | | 0 | | 1 | |
|------|-------|-------|--------|-----|-----|-----|-----|-----|-----|-----|-----|-----|-----|-----|-------|-------|--|---|--|
| | | | 100 | 200 | 201 | 202 | 300 | 400 | 500 | 503 | 601 | 602 | 612 | 630 | INCR. | INCR. | | | |
| | | | 92 | 98 | 102 | 109 | 115 | 123 | 149 | 174 | 195 | 215 | 236 | 279 | C.19 | C.19 | | | |
| ACEX | 60 | 56 1P | 108 | 114 | 119 | 128 | 136 | 146 | 179 | 234 | 253 | 278 | 306 | 362 | 13 | 16 | | | |
| ACEX | 60 | 75 1P | 108 | 114 | 119 | 128 | 136 | 146 | 179 | 234 | 253 | 278 | 306 | 362 | 15 | 18 | | | |

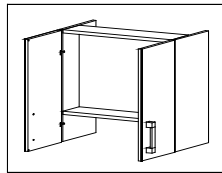

2 PUERTAS

| REF. | ANCHO | ALTO | TARIFA | | | | | | | | | | | | | 0 | | 1 | |
|------|-------|------|--------|-----|-----|-----|-----|-----|-----|-----|-----|-----|-----|-----|-----|------|--|---|--|
| | | | 100 | 200 | 201 | 202 | 300 | 400 | 500 | 503 | 601 | 602 | 612 | 630 | BL. | ANT. | | | |
| | | | 109 | 118 | 123 | 131 | 138 | 146 | 168 | 218 | 262 | 288 | 317 | 375 | 13 | 16 | | | |
| ACEX | 60 | 56 | 124 | 135 | 141 | 151 | 160 | 170 | 197 | 291 | 326 | 359 | 394 | 466 | 15 | 18 | | | |
| ACEX | 60 | 75 | 124 | 135 | 141 | 151 | 160 | 170 | 197 | 291 | 326 | 359 | 394 | 466 | 15 | 18 | | | |

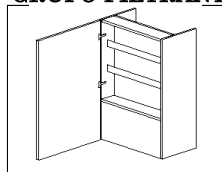
CAMPANAS PARA
GRUPO FILTRANTE

1 PUERTA

| REF. | ANCHO | ALTO | TARIFA | | | | | | | | | | | | | 0 | | 1 | |
|------|-------|----------|--------|-----|-----|-----|-----|-----|-----|-----|-----|-----|-----|-----|-----|------|--|---|--|
| | | | 100 | 200 | 201 | 202 | 300 | 400 | 500 | 503 | 601 | 602 | 612 | 630 | BL. | ANT. | | | |
| | | | 101 | 107 | 112 | 119 | 126 | 135 | 163 | 191 | 215 | 236 | 260 | 307 | 13 | 16 | | | |
| ACI | 60 | 70 1P | 118 | 125 | 130 | 140 | 149 | 160 | 196 | 257 | 278 | 306 | 337 | 398 | 22 | 27 | | | |
| ACI | 60 | 80/90 1P | 118 | 125 | 130 | 140 | 149 | 160 | 196 | 257 | 278 | 306 | 337 | 398 | 22 | 27 | | | |

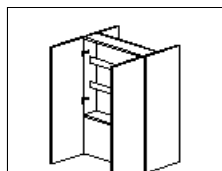

2 PUERTAS

| REF. | ANCHO | ALTO | TARIFA | | | | | | | | | | | | | 0 | | 1 | |
|------|-------|-------|--------|-----|-----|-----|-----|-----|-----|-----|-----|-----|-----|-----|-----|------|--|---|--|
| | | | 100 | 200 | 201 | 202 | 300 | 400 | 500 | 503 | 601 | 602 | 612 | 630 | BL. | ANT. | | | |
| | | | 119 | 129 | 134 | 143 | 151 | 159 | 184 | 239 | 288 | 317 | 349 | 412 | 13 | 16 | | | |
| ACI | 60 | 70 | 135 | 147 | 154 | 165 | 175 | 186 | 216 | 319 | 359 | 394 | 434 | 513 | 22 | 27 | | | |
| ACI | 60 | 80/90 | 135 | 147 | 154 | 165 | 175 | 186 | 216 | 319 | 359 | 394 | 434 | 513 | 22 | 27 | | | |
| ACI | 90 | 70 | 142 | 154 | 161 | 173 | 184 | 197 | 238 | 282 | 329 | 362 | 398 | 470 | 14 | 19 | | | |
| ACI | 90 | 80/90 | 165 | 178 | 187 | 202 | 216 | 232 | 284 | 363 | 386 | 425 | 467 | 552 | 24 | 30 | | | |

RINCONERA

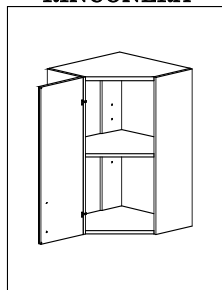

| REF. | ANCHO | ALTO | TARIFA | | | | | | | | | | | | | 0 | | 1 | |
|------|-------|-------|--------|-----|-----|-----|-----|-----|-----|-----|-----|-----|-----|-----|-----|------|----|----|--|
| | | | 100 | 200 | 201 | 202 | 300 | 400 | 500 | 503 | 601 | 602 | 612 | 630 | BL. | ANT. | | | |
| | | | 102 | 106 | 108 | 111 | 114 | 116 | 122 | 126 | 134 | 149 | 186 | 205 | 225 | 266 | 11 | 16 | |
| RIN | 50 | 45 | 119 | 124 | 126 | 129 | 132 | 136 | 144 | 175 | 204 | 224 | 247 | 292 | 12 | 17 | | | |
| RIN | 50 | 70 | 145 | 150 | 152 | 157 | 161 | 165 | 175 | 219 | 246 | 271 | 298 | 352 | 23 | 29 | | | |
| RIN | 50 | 80/90 | 145 | 150 | 152 | 157 | 161 | 165 | 175 | 219 | 246 | 271 | 298 | 352 | 23 | 29 | | | |
| RIN | 50 | 127 | 173 | 180 | 184 | 188 | 191 | 197 | 219 | 305 | 301 | 331 | 364 | 430 | 24 | 30 | | | |
| RIN | 50 | 147 | 181 | 190 | 194 | 200 | 206 | 213 | 226 | 347 | 321 | 353 | 388 | 459 | 25 | 31 | | | |
| RIN | 60 | 45 | 109 | 114 | 116 | 120 | 123 | 126 | 134 | 149 | 186 | 205 | 225 | 266 | 14 | 18 | | | |
| RIN | 60 | 70 | 129 | 134 | 137 | 142 | 146 | 152 | 167 | 186 | 219 | 241 | 265 | 313 | 15 | 20 | | | |
| RIN | 60 | 80/90 | 129 | 134 | 137 | 142 | 146 | 152 | 167 | 186 | 219 | 241 | 265 | 313 | 15 | 20 | | | |
| RIN | 60 | 127 | 157 | 163 | 167 | 173 | 179 | 186 | 205 | 239 | 266 | 293 | 322 | 380 | 25 | 31 | | | |
| RIN | 60 | 127 | 182 | 190 | 195 | 202 | 209 | 219 | 254 | 325 | 316 | 348 | 382 | 452 | 26 | 33 | | | |
| RIN | 60 | 147 | 197 | 207 | 212 | 221 | 230 | 242 | 267 | 371 | 342 | 376 | 414 | 489 | 27 | 34 | | | |

RINCONERA VITRINA

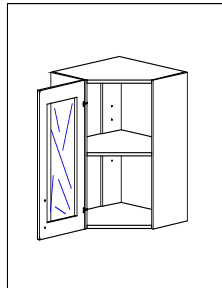

| REF. | ANCHO | ALTO | TARIFA | | | | | | | | | | | | | 0 | | 1 | |
|------|-------|-------|--------|-----|-----|-----|-----|-----|-----|------|------|------|------|------|----|----|--|---|--|
| | | | 500 | 503 | 601 | 602 | 612 | 630 | BL. | ANT. | | | | | | | | | |
| | | | 172 | 187 | 223 | 245 | 270 | 319 | 11 | 16 | | | | | | | | | |
| RINV | 50 | 45 | 210 | 230 | 272 | 299 | 329 | 389 | 482 | 605 | 702 | 859 | 1000 | 12 | 17 | | | | |
| RINV | 50 | 70 | 255 | 284 | 337 | 371 | 408 | 482 | 605 | 702 | 859 | 1000 | 1200 | 23 | 29 | | | | |
| RINV | 50 | 80/90 | 255 | 284 | 337 | 371 | 408 | 482 | 605 | 702 | 859 | 1000 | 1200 | 23 | 29 | | | | |
| RINV | 50 | 127 | 318 | 390 | 423 | 465 | 512 | 605 | 702 | 859 | 1000 | 1200 | 1400 | 24 | 30 | | | | |
| RINV | 50 | 147 | 363 | 453 | 491 | 540 | 594 | 702 | 859 | 1000 | 1200 | 1400 | 1600 | 25 | 31 | | | | |
| RINV | 60 | 45 | 191 | 204 | 245 | 270 | 296 | 350 | 418 | 502 | 545 | 600 | 659 | 779 | 14 | 18 | | | |
| RINV | 60 | 70 | 234 | 251 | 298 | 328 | 361 | 426 | 513 | 554 | 606 | 666 | 734 | 871 | 15 | 20 | | | |
| RINV | 60 | 80/90 | 234 | 251 | 298 | 328 | 361 | 426 | 513 | 554 | 606 | 666 | 734 | 871 | 15 | 20 | | | |
| RINV | 60 | 127 | 289 | 315 | 368 | 405 | 445 | 526 | 633 | 684 | 746 | 818 | 900 | 1062 | 25 | 31 | | | |
| RINV | 60 | 127 | 358 | 425 | 466 | 513 | 564 | 666 | 798 | 861 | 924 | 1000 | 1100 | 1266 | 26 | 33 | | | |
| RINV | 60 | 147 | 418 | 502 | 545 | 600 | 659 | 779 | 936 | 1000 | 1100 | 1200 | 1300 | 1500 | 27 | 34 | | | |

RINCONERA ANGULAR

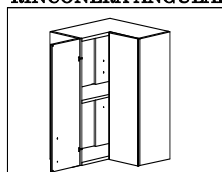

| REF. | ANCHO | ALTO | TARIFA | | | | | | | | | | | | | 0 | | 1 | |
|------|-------|-------|--------|-----|-----|-----|-----|-----|-----|-----|-----|-----|-----|-----|-----|------|--|---|--|
| | | | 100 | 200 | 201 | 202 | 300 | 400 | 500 | 503 | 601 | 602 | 612 | 630 | BL. | ANT. | | | |
| | | | 155 | 163 | 166 | 172 | 178 | 183 | 194 | 203 | 290 | 319 | 351 | 415 | 15 | 19 | | | |
| RINL | 60 | 45 | 178 | 187 | 192 | 200 | 207 | 215 | 237 | 287 | 337 | 371 | 408 | 482 | 16 | 21 | | | |
| RINL | 60 | 70 | 212 | 224 | 230 | 240 | 249 | 259 | 285 | 359 | 402 | 442 | 486 | 575 | 26 | 32 | | | |
| RINL | 60 | 80/90 | 212 | 224 | 230 | 240 | 249 | 259 | 285 | 359 | 402 | 442 | 486 | 575 | 26 | 32 | | | |
| RINL | 60 | 127 | 250 | 265 | 273 | 283 | 292 | 307 | 358 | 511 | 487 | 536 | 589 | 696 | 27 | 34 | | | |
| RINL | 60 | 147 | 262 | 281 | 290 | 305 | 319 | 335 | 368 | 589 | 524 | 576 | 634 | 749 | 28 | 35 | | | |

**ALTOS
PUERTAS PLEGABLES**

TARIFA

0 1
INCR. INCR.

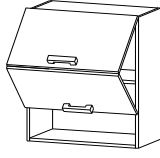
| REF. | ANCHO | ALTO | 100 | 200 | 201 | 202 | 300 | 400 | 500 | 503 | 601 | 602 | 612 | 630 | C.19 | | |
|--|-------|-------|-------|-----|-----|-----|-----|-----|-----|-----|-----|-----|-----|-----|------|------|----|
| | | | | | | | | | | | | | | | BL. | ANT. | |
|  | AP | 60 | 70 | 278 | 288 | 293 | 301 | 308 | 316 | 337 | 397 | 438 | 482 | 530 | 626 | 13 | 16 |
| | AP | 70 | | 285 | 295 | 301 | 310 | 319 | 329 | 357 | 403 | 458 | 504 | 554 | 655 | 13 | 17 |
| | AP | 80 | | 292 | 303 | 309 | 320 | 330 | 341 | 373 | 438 | 473 | 520 | 572 | 676 | 14 | 18 |
| | AP | 90 | * | 304 | 316 | 323 | 334 | 345 | 358 | 393 | 466 | 504 | 554 | 610 | 721 | 14 | 19 |
| | AP | 100 | * | 314 | 328 | 337 | 348 | 359 | 376 | 434 | 576 | 538 | 592 | 651 | 769 | 15 | 19 |
| | REF. | ANCHO | ALTO | | | | | | | | | | | | | | |
| | AP | 60 | 80/90 | 325 | 337 | 343 | 352 | 360 | 370 | 394 | 464 | 512 | 564 | 620 | 733 | 22 | 27 |
| | AP | 70 | | 333 | 345 | 352 | 363 | 373 | 385 | 418 | 472 | 536 | 589 | 648 | 766 | 23 | 28 |
| | AP | 80 | | 342 | 355 | 362 | 374 | 386 | 399 | 436 | 512 | 553 | 609 | 670 | 791 | 23 | 29 |
| | AP | 90 | * | 356 | 370 | 378 | 391 | 404 | 419 | 460 | 545 | 590 | 649 | 714 | 843 | 24 | 30 |
| | AP | 100 | * | 368 | 384 | 395 | 408 | 420 | 440 | 508 | 674 | 630 | 693 | 762 | 901 | 25 | 31 |

VITRINA P. PLEGABLES

| REF. | ANCHO | ALTO | 500 | 503 | 601 | 602 | 612 | 630 | BL. | | ANT. | |
|--|-------|-------|-------|-----|-----|-----|-----|------|------|----|------|--|
| | | | | | | | | | | | | |
|  | AVP | 60 | 70 | 436 | 473 | 547 | 602 | 662 | 782 | 13 | 16 | |
| | AVP | 70 | | 460 | 502 | 584 | 642 | 707 | 835 | 13 | 17 | |
| | AVP | 80 | | 498 | 549 | 524 | 576 | 634 | 749 | 14 | 18 | |
| | AVP | 90 | * | 532 | 589 | 572 | 629 | 692 | 818 | 14 | 19 | |
| | AVP | 100 | * | 576 | 702 | 734 | 807 | 888 | 1050 | 15 | 19 | |
| | REF. | ANCHO | ALTO | | | | | | | | | |
| | AVP | 60 | 80/90 | 510 | 553 | 640 | 704 | 774 | 915 | 22 | 27 | |
| | AVP | 70 | | 538 | 587 | 683 | 752 | 827 | 977 | 23 | 28 | |
| | AVP | 80 | | 583 | 642 | 613 | 674 | 742 | 877 | 23 | 29 | |
| | AVP | 90 | * | 623 | 689 | 670 | 737 | 811 | 958 | 24 | 30 | |
| | AVP | 100 | * | 674 | 822 | 859 | 945 | 1039 | 1228 | 25 | 31 | |

**ESCURREPL. P. PLEG.
VARILLA INOX**

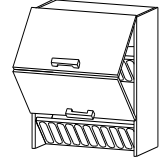
| REF. | ANCHO | ALTO | 100 | 200 | 201 | 202 | 300 | 400 | 500 | 503 | 601 | 602 | 612 | 630 | BL. | | ANT. | |
|---|-------|-------|-------|-----|-----|-----|-----|-----|-----|-----|-----|-----|-----|-----|-----|---|------|--|
| | | | | | | | | | | | | | | | | | | |
|  | AEP | 60 | 70 | 329 | 339 | 343 | 351 | 359 | 367 | 387 | 447 | 489 | 538 | 592 | 699 | 3 | 6 | |
| | AEP | 70 | | 341 | 351 | 356 | 366 | 375 | 385 | 413 | 458 | 514 | 565 | 622 | 735 | 4 | 7 | |
| | AEP | 80 | | 353 | 369 | 370 | 380 | 390 | 402 | 433 | 499 | 534 | 587 | 646 | 764 | 4 | 7 | |
| | AEP | 90 | * | 363 | 376 | 383 | 394 | 405 | 418 | 453 | 526 | 564 | 620 | 682 | 807 | 5 | 8 | |
| | REF. | ANCHO | ALTO | | | | | | | | | | | | | | | |
| | AEP | 60 | 80/90 | 385 | 397 | 401 | 411 | 420 | 429 | 453 | 523 | 572 | 629 | 692 | 818 | 5 | 8 | |
| | AEP | 70 | | 399 | 411 | 417 | 428 | 439 | 450 | 483 | 536 | 601 | 662 | 728 | 860 | 5 | 8 | |
| | AEP | 80 | | 413 | 432 | 433 | 445 | 456 | 470 | 507 | 584 | 625 | 687 | 756 | 893 | 6 | 10 | |
| | AEP | 90 | * | 425 | 440 | 448 | 461 | 474 | 489 | 530 | 615 | 660 | 726 | 798 | 944 | 6 | 10 | |

INCREMENTO POR COSTADO VISTO INCORPORADO EN EL MUEBLE ALTO

INCREMENTO POR
COSTADO VISTO
FONDO - 33

| REF. | ANCHO | ALTO | 100 | 200 | 201 | 202 | 300 | 400 | 500 | 503 | 601 | 602 | 612 | 630 |
|------|-------|------|-----|-----|-----|-----|-----|-----|-----|-----|-----|-----|-----|-----|
| ICA | 35 | | 14 | 16 | 17 | 19 | 21 | 24 | 31 | 51 | 42 | 46 | 46 | 46 |
| ICA | 45 | | 15 | 17 | 18 | 21 | 24 | 27 | 31 | 53 | 42 | 46 | 46 | 46 |
| ICA | 70 | | 19 | 21 | 23 | 27 | 31 | 36 | 40 | 58 | 50 | 55 | 55 | 55 |
| ICA | 80 | | 21 | 24 | 27 | 32 | 37 | 43 | 49 | 71 | 62 | 68 | 68 | 68 |
| ICA | 90 | | 21 | 24 | 27 | 32 | 37 | 43 | 49 | 71 | 62 | 68 | 68 | 68 |
| ICA | 127 | | 26 | 29 | 34 | 41 | 48 | 57 | 62 | 81 | 84 | 92 | 92 | 92 |
| ICA | 147 | | 31 | 35 | 41 | 49 | 58 | 68 | 74 | 97 | 101 | 111 | 111 | 111 |
| ICA | 200 | | 36 | 41 | 48 | 60 | 72 | 88 | 97 | 162 | 126 | 139 | 139 | 139 |
| ICA | 220 | | 38 | 43 | 52 | 65 | 78 | 92 | 130 | 173 | 141 | 155 | 155 | 155 |

TARIFA

BAJOS

| REF. | ANCHO | ALTO | 100 | 200 | 201 | 202 | 300 | 400 | 500 | 503 | 601 | 602 | 612 | 630 |
|----------|-----------|-----------|-----|-----|-----|-----|-----|-----|-----|-----|-----|-----|-----|-----|
| B | 25 | 70 | 86 | 91 | 93 | 97 | 100 | 103 | 111 | 142 | 170 | 187 | 206 | 243 |
| B | 30 | | 89 | 94 | 96 | 100 | 104 | 108 | 119 | 144 | 172 | 189 | 208 | 246 |
| B | 35 | | 93 | 98 | 100 | 105 | 109 | 114 | 127 | 148 | 179 | 197 | 217 | 256 |
| B | 40 | | 96 | 101 | 104 | 109 | 113 | 119 | 134 | 153 | 184 | 202 | 223 | 263 |
| B | 45 | | 102 | 107 | 110 | 116 | 121 | 127 | 145 | 165 | 194 | 213 | 235 | 277 |
| B | 50 | | 105 | 111 | 114 | 120 | 126 | 132 | 153 | 174 | 201 | 221 | 243 | 287 |
| B | 60 | 1P | 113 | 119 | 123 | 130 | 136 | 144 | 170 | 195 | 222 | 244 | 269 | 317 |

1 PUERTA

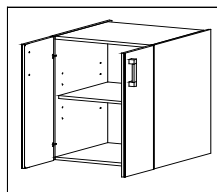

| REF. | ANCHO | ALTO | 100 | 200 | 201 | 202 | 300 | 400 | 500 | 503 | 601 | 602 | 612 | 630 |
|----------|------------|-----------|-----|-----|-----|-----|-----|-----|-----|-----|-----|-----|-----|-----|
| B | 60 | 70 | 132 | 141 | 146 | 154 | 162 | 170 | 191 | 241 | 291 | 320 | 352 | 416 |
| B | 70 | | 141 | 151 | 156 | 165 | 173 | 182 | 209 | 252 | 306 | 337 | 370 | 438 |
| B | 80 | | 148 | 158 | 164 | 174 | 183 | 194 | 224 | 263 | 318 | 350 | 385 | 455 |
| B | 90 | | 153 | 164 | 170 | 181 | 191 | 203 | 240 | 280 | 329 | 362 | 398 | 470 |
| B | 100 | | 161 | 173 | 180 | 192 | 203 | 216 | 258 | 300 | 347 | 382 | 420 | 496 |

2 PUERTAS

FREGADEROS

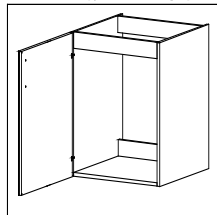

| REF. | ANCHO | ALTO | 100 | 200 | 201 | 202 | 300 | 400 | 500 | 503 | 601 | 602 | 612 | 630 |
|-----------|-----------|-----------|-----|-----|-----|-----|-----|-----|-----|-----|-----|-----|-----|-----|
| SF | 45 | 70 | 91 | 97 | 100 | 105 | 110 | 116 | 134 | 155 | 180 | 198 | 218 | 257 |
| SF | 50 | | 93 | 99 | 102 | 108 | 114 | 121 | 141 | 162 | 186 | 205 | 225 | 266 |
| SF | 60 | 1P | 98 | 104 | 108 | 115 | 121 | 129 | 155 | 180 | 203 | 223 | 246 | 290 |

CON BANDEJA

| | | | | | | | | | | | | | | |
|------------|-----------|-----------|-----|-----|-----|-----|-----|-----|-----|-----|-----|-----|-----|-----|
| SFB | 45 | 70 | 109 | 115 | 118 | 123 | 128 | 134 | 152 | 173 | 198 | 218 | 240 | 283 |
| SFB | 50 | | 113 | 119 | 122 | 128 | 134 | 141 | 161 | 182 | 206 | 227 | 249 | 295 |
| SFB | 60 | 1P | 121 | 127 | 131 | 138 | 144 | 152 | 178 | 203 | 226 | 249 | 273 | 323 |

1 PUERTA

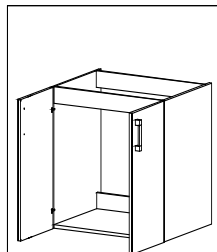

| REF. | ANCHO | ALTO | 100 | 200 | 201 | 202 | 300 | 400 | 500 | 503 | 601 | 602 | 612 | 630 |
|-----------|------------|-----------|-----|-----|-----|-----|-----|-----|-----|-----|-----|-----|-----|-----|
| SF | 60 | 70 | 117 | 127 | 131 | 139 | 147 | 155 | 176 | 226 | 272 | 299 | 329 | 389 |
| SF | 70 | | 122 | 132 | 137 | 146 | 154 | 164 | 190 | 233 | 283 | 311 | 342 | 405 |
| SF | 80 | | 127 | 138 | 143 | 153 | 163 | 173 | 204 | 242 | 292 | 321 | 353 | 418 |
| SF | 90 | | 132 | 143 | 149 | 160 | 170 | 182 | 218 | 259 | 302 | 332 | 365 | 432 |
| SF | 100 | | 137 | 149 | 155 | 167 | 178 | 192 | 233 | 275 | 316 | 348 | 382 | 452 |
| SF | 120 | | 158 | 174 | 182 | 197 | 211 | 227 | 273 | 331 | 407 | 448 | 492 | 582 |

CON BANDEJA

| | | | | | | | | | | | | | | |
|------------|------------|-----------|-----|-----|-----|-----|-----|-----|-----|-----|-----|-----|-----|-----|
| SFB | 60 | 70 | 140 | 150 | 154 | 162 | 170 | 178 | 199 | 249 | 295 | 325 | 357 | 422 |
| SFB | 70 | | 147 | 157 | 162 | 171 | 179 | 189 | 215 | 258 | 308 | 339 | 373 | 440 |
| SFB | 80 | | 154 | 165 | 170 | 180 | 190 | 200 | 231 | 269 | 319 | 351 | 386 | 456 |
| SFB | 90 | | 161 | 172 | 178 | 189 | 199 | 211 | 247 | 288 | 331 | 364 | 401 | 473 |
| SFB | 100 | | 168 | 180 | 186 | 198 | 209 | 223 | 264 | 306 | 347 | 382 | 420 | 496 |
| SFB | 120 | | 190 | 206 | 214 | 229 | 243 | 259 | 305 | 363 | 439 | 480 | 524 | 614 |

2 PUERTAS

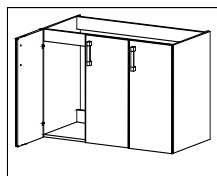

| REF. | ANCHO | ALTO | 100 | 200 | 201 | 202 | 300 | 400 | 500 | 503 | 601 | 602 | 612 | 630 |
|-----------|------------|-----------|-----|-----|-----|-----|-----|-----|-----|-----|-----|-----|-----|-----|
| SF | 135 | 70 | 172 | 188 | 197 | 213 | 229 | 247 | 301 | 362 | 423 | 465 | 512 | 605 |

3 PUERTAS

SOPORTE PLACA

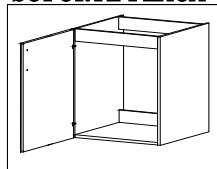

| REF. | ANCHO | ALTO | 100 | 200 | 201 | 202 | 300 | 400 | 500 | 503 | 601 | 602 | 612 | 630 |
|-----------|-----------|--------------|-----|-----|-----|-----|-----|-----|-----|-----|-----|-----|-----|-----|
| SP | 60 | 70 1P | 108 | 113 | 117 | 123 | 130 | 137 | 162 | 186 | 211 | 232 | 255 | 302 |

1 PUERTA

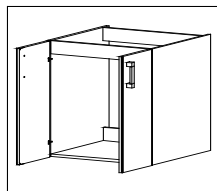

| REF. | ANCHO | ALTO | 100 | 200 | 201 | 202 | 300 | 400 | 500 | 503 | 601 | 602 | 612 | 630 |
|-----------|-----------|-----------|-----|-----|-----|-----|-----|-----|-----|-----|-----|-----|-----|-----|
| SP | 60 | 70 | 126 | 135 | 139 | 147 | 155 | 162 | 182 | 230 | 276 | 304 | 335 | 395 |

2 PUERTAS

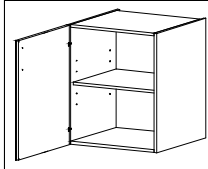
| BAJOS | TARIFA | | | | | | | | | | | | | | | 0 | | 1 | |
|--|--------|-------|------|-----|-----|-----|-----|-----|-----|-----|-----|-----|-----|-----|-----|-----|------|------|--|
| | REF. | ANCHO | ALTO | 100 | 200 | 201 | 202 | 300 | 400 | 500 | 503 | 601 | 602 | 612 | 630 | BL. | ANT. | | |
| | | | | | | | | | | | | | | | | | C.19 | C.19 | |
|  | B | 25 | 80 | 93 | 98 | 100 | 104 | 108 | 111 | 122 | 156 | 187 | 206 | 226 | 267 | 14 | 19 | | |
| | B | 30 | | 96 | 102 | 104 | 108 | 112 | 117 | 131 | 158 | 189 | 208 | 229 | 271 | 14 | 19 | | |
| | B | 35 | | 100 | 106 | 108 | 113 | 118 | 123 | 140 | 163 | 197 | 217 | 238 | 282 | 15 | 20 | | |
| | B | 40 | | 104 | 109 | 112 | 117 | 122 | 129 | 147 | 168 | 202 | 223 | 245 | 289 | 16 | 21 | | |
| | B | 45 | | 110 | 116 | 119 | 125 | 131 | 137 | 160 | 182 | 213 | 235 | 258 | 305 | 17 | 22 | | |
| | B | 50 | | 113 | 120 | 123 | 130 | 136 | 143 | 168 | 191 | 221 | 243 | 268 | 316 | 17 | 22 | | |
| | B | 60 | 1P | 122 | 129 | 133 | 140 | 147 | 156 | 187 | 215 | 244 | 269 | 295 | 349 | 19 | 23 | | |

1 PUERTA

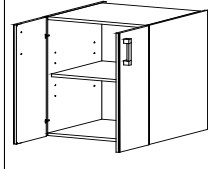
| 2 PUERTAS | REF. | ANCHO | ALTO | 100 | 200 | 201 | 202 | 300 | 400 | 500 | 503 | 601 | 602 | 612 | 630 | BL. | ANT. |
|-----------|--|-------|------|-----|-----|-----|-----|-----|-----|-----|-----|-----|-----|-----|-----|-----|------|
| |  | B | 60 | 80 | 144 | 154 | 159 | 168 | 177 | 185 | 212 | 268 | 323 | 355 | 391 | 462 | 19 |
| B | | 70 | | 154 | 165 | 170 | 179 | 189 | 198 | 232 | 280 | 340 | 374 | 411 | 486 | 20 | 24 |
| B | | 80 | | 161 | 172 | 179 | 189 | 199 | 211 | 249 | 292 | 353 | 388 | 427 | 505 | 22 | 26 |
| B | | 90 | | 167 | 179 | 185 | 197 | 208 | 221 | 266 | 311 | 365 | 402 | 442 | 522 | 24 | 26 |
| B | | 100 | | 175 | 189 | 196 | 209 | 221 | 235 | 286 | 333 | 385 | 424 | 466 | 551 | 25 | 27 |

2 PUERTAS

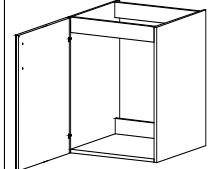
| FREGADEROS | REF. | ANCHO | ALTO | TARIFA | | | | | | | | | | | | 0 | | 1 | |
|--|------|-------|------|--------|-----|-----|-----|-----|-----|-----|-----|-----|-----|-----|-----|-----|------|---|--|
| | | | | 100 | 200 | 201 | 202 | 300 | 400 | 500 | 503 | 601 | 602 | 612 | 630 | BL. | ANT. | | |
| | | | | | | | | | | | | | | | | | | | |
|  | SF | 45 | 80 | 98 | 105 | 108 | 113 | 119 | 125 | 147 | 171 | 198 | 218 | 240 | 283 | 9 | 14 | | |
| | SF | 50 | | 100 | 107 | 110 | 117 | 123 | 131 | 155 | 178 | 205 | 225 | 248 | 293 | 9 | 15 | | |
| | SF | 60 | 1P | 106 | 112 | 117 | 124 | 131 | 139 | 171 | 198 | 223 | 246 | 270 | 319 | 10 | 16 | | |
| CON BANDEJA | | | | | | | | | | | | | | | | | | | |
| SFB | 45 | 80 | 118 | 124 | 127 | 133 | 138 | 145 | 167 | 190 | 218 | 240 | 264 | 311 | 9 | 14 | | | |
| SFB | 50 | | 122 | 129 | 132 | 138 | 145 | 152 | 177 | 200 | 227 | 249 | 274 | 324 | 9 | 15 | | | |
| SFB | 60 | 1P | 131 | 137 | 141 | 149 | 156 | 164 | 196 | 223 | 249 | 273 | 301 | 355 | 10 | 16 | | | |

1 PUERTA

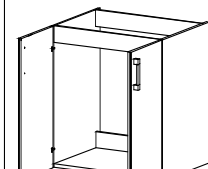
| 2 PUERTAS | REF. | ANCHO | ALTO | TARIFA | | | | | | | | | | | | 0 | | 1 | |
|--|--------------------|-------|------|--------|-----|-----|-----|-----|-----|-----|-----|-----|-----|-----|-----|-----|------|---|--|
| | | | | 100 | 200 | 201 | 202 | 300 | 400 | 500 | 503 | 601 | 602 | 612 | 630 | BL. | ANT. | | |
| | | | | | | | | | | | | | | | | | | | |
|  | SF | 60 | 80 | 128 | 138 | 143 | 152 | 160 | 169 | 195 | 251 | 302 | 332 | 365 | 432 | 10 | 16 | | |
| | SF | 70 | | 133 | 144 | 149 | 159 | 168 | 179 | 211 | 259 | 314 | 346 | 380 | 449 | 11 | 17 | | |
| | SF | 80 | | 138 | 150 | 156 | 167 | 178 | 189 | 226 | 269 | 324 | 357 | 392 | 463 | 11 | 18 | | |
| | SF | 90 | | 144 | 156 | 162 | 174 | 185 | 198 | 242 | 287 | 335 | 369 | 406 | 479 | 12 | 19 | | |
| | SF | 100 | | 149 | 162 | 169 | 181 | 194 | 209 | 259 | 305 | 351 | 386 | 424 | 502 | 13 | 20 | | |
| | SF | 120 | | 172 | 190 | 198 | 214 | 230 | 247 | 303 | 367 | 452 | 497 | 547 | 646 | 14 | 22 | | |
| | CON BANDEJA | | | | | | | | | | | | | | | | | | |
| SFB | 60 | 80 | 153 | 164 | 168 | 177 | 185 | 194 | 221 | 276 | 327 | 360 | 396 | 468 | 10 | 16 | | | |
| SFB | 70 | | 160 | 171 | 177 | 186 | 195 | 206 | 239 | 286 | 342 | 376 | 414 | 489 | 11 | 17 | | | |
| SFB | 80 | | 168 | 180 | 185 | 196 | 207 | 218 | 256 | 299 | 354 | 389 | 428 | 506 | 11 | 18 | | | |
| SFB | 90 | | 175 | 187 | 194 | 205 | 217 | 230 | 274 | 320 | 367 | 404 | 445 | 525 | 12 | 19 | | | |
| SFB | 100 | | 183 | 196 | 203 | 215 | 228 | 243 | 293 | 340 | 385 | 424 | 466 | 551 | 13 | 20 | | | |
| SFB | 120 | | 212 | 230 | 238 | 254 | 270 | 287 | 343 | 407 | 492 | 537 | 653 | 764 | 14 | 22 | | | |

2 PUERTAS

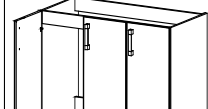
| 3 PUERTAS | REF. | ANCHO | ALTO | 100 | 200 | 201 | 202 | 300 | 400 | 500 | 503 | 601 | 602 | 612 | 630 | BL. | ANT. |
|-----------|--|-------|------|-----|-----|-----|-----|-----|-----|-----|-----|-----|-----|-----|-----|-----|------|
| |  | SF | 135 | 80 | 187 | 205 | 215 | 232 | 250 | 269 | 334 | 402 | 470 | 516 | 568 | 671 | 15 |

3 PUERTAS

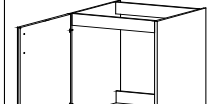
| SOPORTE PLACA | REF. | ANCHO | ALTO | TARIFA | | | | | | | | | | | | 0 | | 1 | |
|--|------|-------|-------|--------|-----|-----|-----|-----|-----|-----|-----|-----|-----|-----|-----|-----|------|---|--|
| | | | | 100 | 200 | 201 | 202 | 300 | 400 | 500 | 503 | 601 | 602 | 612 | 630 | BL. | ANT. | | |
|  | SP | 60 | 80 1P | 116 | 122 | 127 | 133 | 140 | 148 | 178 | 204 | 232 | 255 | 281 | 332 | 10 | 16 | | |

1 PUERTA

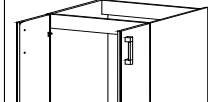
| 2 PUERTAS | REF. | ANCHO | ALTO | TARIFA | | | | | | | | | | | | 0 | | 1 | |
|--|------|-------|------|--------|-----|-----|-----|-----|-----|-----|-----|-----|-----|-----|-----|-----|------|---|--|
| | | | | 100 | 200 | 201 | 202 | 300 | 400 | 500 | 503 | 601 | 602 | 612 | 630 | BL. | ANT. | | |
|  | SP | 60 | 80 | 136 | 145 | 150 | 159 | 167 | 175 | 200 | 253 | 304 | 335 | 368 | 435 | 10 | 16 | | |

2 PUERTAS

**BAJOS
SOP.PLACA-HORNO**

TARIFA

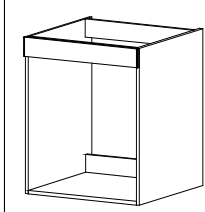

| REF. | ANCHO | ALTO | 100 | 200 | 201 | 202 | 300 | 400 | 500 | 503 | 601 | 602 | 612 | 630 |
|--|-----------|-----------|-----|-----|-----|-----|-----|-----|-----|-----|-----|-----|-----|-----|
| SPH | 60 | 70 | 76 | 77 | 82 | 84 | 85 | 91 | 98 | 110 | 114 | 125 | 138 | 163 |
| SPHR (con rejilla ventilación) | 60 | 70 | 80 | 80 | 80 | 80 | 80 | 80 | 80 | 80 | 89 | 98 | 108 | 127 |
| SPHCZ (cajon bajo zocalo) | 60 | 70 | 216 | 217 | 222 | 224 | 225 | 231 | 238 | 250 | 254 | 279 | 307 | 363 |

NOTA: EL CAJON BAJO ZOCALO ESTA DISPONIBLE SOLO PARA INTERIOR DE 16 MMS

**SOP.PLACA-HORNO
CON CACEROLERO**

PARA HORNO DE 45 DE ALTURA

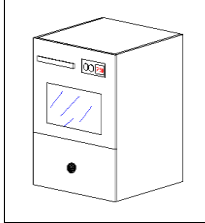

| REF. | ANCHO | ALTO | 100 | 200 | 201 | 202 | 300 | 400 | 500 | 503 | 601 | 602 | 612 | 630 |
|-------------|-----------|---------------------|-----|-----|-----|-----|-----|-----|-----|-----|-----|-----|-----|-----|
| BHCM | 60 | METAL 70 | 145 | 150 | 152 | 156 | 160 | 165 | 176 | 197 | 240 | 264 | 290 | 343 |
| BHCA | 60 | FRENO 70 | 182 | 187 | 190 | 194 | 198 | 202 | 214 | 235 | 278 | 306 | 336 | 398 |

**SOP.FREGADERO 60
PTA EXTRAIBLE
1 CACER.INTERIOR**

HETTICH

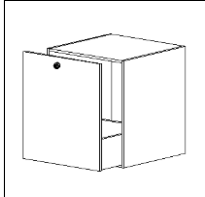

| REF. | ANCHO | ALTO | 100 | 200 | 201 | 202 | 300 | 400 | 500 | 503 | 601 | 602 | 612 | 630 |
|------------|-----------|--------------|-----|-----|-----|-----|-----|-----|-----|-----|-----|-----|-----|-----|
| SFC | 60 | 70 1P | 184 | 189 | 193 | 200 | 206 | 213 | 238 | 262 | 293 | 322 | 355 | 419 |

BAJO RINCON

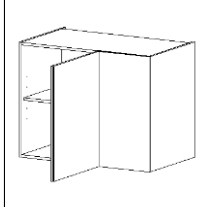

| REF. | ANCHO | ALTO | 100 | 200 | 201 | 202 | 300 | 400 | 500 | 503 | 601 | 602 | 612 | 630 |
|-----------|------------|-----------|-----|-----|-----|-----|-----|-----|-----|-----|-----|-----|-----|-----|
| RB | 90 | 70 | 155 | 166 | 172 | 183 | 193 | 205 | 226 | 266 | 321 | 353 | 388 | 459 |
| RB | 100 | | 163 | 175 | 182 | 194 | 205 | 218 | 244 | 286 | 339 | 373 | 410 | 485 |
| RB | 120 | | 180 | 196 | 204 | 219 | 233 | 249 | 279 | 337 | 419 | 461 | 507 | 599 |
| RB | 135 | | 188 | 204 | 213 | 229 | 245 | 263 | 301 | 362 | 435 | 479 | 526 | 622 |

**BAJO RINCON
ANGULAR**

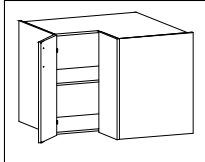

| REF. | ANCHO | ALTO | 100 | 200 | 201 | 202 | 300 | 400 | 500 | 503 | 601 | 602 | 612 | 630 |
|------------|-----------------|------|-----|-----|-----|-----|-----|-----|-----|-----|-----|-----|-----|-----|
| RBA | 90x 90 | | 237 | 247 | 261 | 271 | 281 | 288 | 312 | 396 | 427 | 470 | 517 | 611 |
| RBA | 100x 100 | | 266 | 276 | 294 | 306 | 318 | 324 | 367 | 436 | 476 | 524 | 576 | 681 |

**BOTELLERO PANERO
CROMO - FRENO**

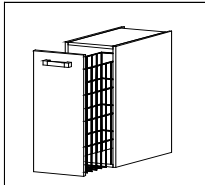

| REF. | ANCHO | ALTO | 100 | 200 | 201 | 202 | 300 | 400 | 500 | 503 | 601 | 602 | 612 | 630 |
|------------|-----------|-----------|-----|-----|-----|-----|-----|-----|-----|-----|-----|-----|-----|-----|
| BB | 15 | 70 | 223 | 228 | 230 | 234 | 237 | 240 | 248 | 279 | 313 | 344 | 379 | 448 |
| BBP | 30 | | 259 | 264 | 266 | 270 | 274 | 278 | 289 | 314 | 348 | 383 | 421 | 498 |
| BBP | 40 | | 273 | 278 | 281 | 286 | 290 | 296 | 311 | 330 | 367 | 404 | 444 | 525 |

TERMINAL BAJO

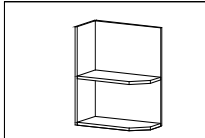

| REF. | ANCHO | ALTO | 100 | 200 | 201 | 202 | 300 | 400 | 500 | 503 | 601 | 602 | 612 | 630 |
|-----------|-----------|-----------|-----|-----|-----|-----|-----|-----|-----|-----|-----|-----|-----|-----|
| TB | 30 | 70 | 88 | 99 | 107 | 119 | 131 | 150 | 173 | 196 | 189 | 208 | 208 | 208 |

TERM.BAJO PUERTA

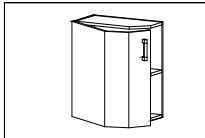

| REF. | ANCHO | ALTO | 100 | 200 | 201 | 202 | 300 | 400 | 500 | 503 | 601 | 602 | 612 | 630 |
|------------|-----------|-----------|-----|-----|-----|-----|-----|-----|-----|-----|-----|-----|-----|-----|
| TBP | 30 | 70 | 172 | 192 | 211 | 220 | 228 | 244 | 271 | 356 | 459 | 505 | 555 | 656 |

**BAJOS
SOP.PLACA-HORNO**

TARIFA

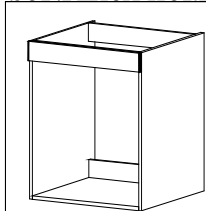

| REF. | ANCHO | ALTO | TARIFA | | | | | | | | | | | | 0 | | 1 | |
|--|-----------|-----------|--------|-----|-----|-----|-----|-----|-----|-----|-----|-----|-----|-----|-------|-------|---|--|
| | | | 100 | 200 | 201 | 202 | 300 | 400 | 500 | 503 | 601 | 602 | 612 | 630 | INCR. | INCR. | | |
| SPH | 60 | 80 | 81 | 82 | 88 | 89 | 91 | 97 | 107 | 120 | 124 | 137 | 150 | 178 | C.19 | C.19 | | |
| SPHR (con rejilla ventilación) | 60 | 80 | 86 | 86 | 86 | 86 | 86 | 86 | 87 | 87 | 97 | 107 | 117 | 139 | BL. | ANT. | | |
| SPHCZ (cajon bajo zocalo) | 60 | 80 | 231 | 232 | 238 | 239 | 241 | 247 | 259 | 273 | 277 | 305 | 335 | 396 | 10 | 16 | | |

NOTA: EL CAJON BAJO ZOCALO ESTA DISPONIBLE SOLO PARA INTERIOR DE 16 MMS

**SOP.PLACA-HORNO
CON CACEROLERO**

PARA HORNO DE 45 ALTURA

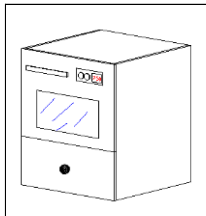

| REF. | ANCHO | ALTO | TARIFA | | | | | | | | | | | | BL. | | ANT. | |
|-------------|-----------|--------------------|--------|-----|-----|-----|-----|-----|-----|-----|-----|-----|-----|-----|-----|----|------|--|
| | | | 100 | 200 | 201 | 202 | 300 | 400 | 500 | 503 | 601 | 602 | 612 | 630 | | | | |
| BHCM | 60 | 80 METAL | 155 | 160 | 163 | 167 | 171 | 176 | 192 | 215 | 262 | 288 | 317 | 374 | 10 | 16 | | |
| BHCA | 60 | 80 FRENO | 195 | 200 | 203 | 207 | 212 | 216 | 233 | 256 | 303 | 333 | 367 | 433 | 10 | 16 | | |

**SOP.FREGADERO 60
PTA EXTRAIBLE
1 CACER.INTERIOR**

HETTICH

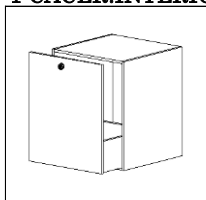

| REF. | ANCHO | ALTO | TARIFA | | | | | | | | | | | | BL. | | ANT. | |
|------------|-----------|--------------|--------|-----|-----|-----|-----|-----|-----|-----|-----|-----|-----|-----|-----|----|------|--|
| | | | 100 | 200 | 201 | 202 | 300 | 400 | 500 | 503 | 601 | 602 | 612 | 630 | | | | |
| SFC | 60 | 80 1P | 195 | 200 | 205 | 211 | 218 | 226 | 255 | 280 | 314 | 345 | 379 | 448 | 10 | 16 | | |

BAJO RINCON

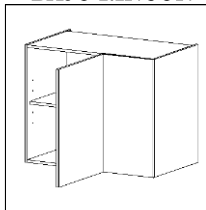

| REF. | ANCHO | ALTO | TARIFA | | | | | | | | | | | | BL. | | ANT. | |
|-----------|------------|-----------|--------|-----|-----|-----|-----|-----|-----|-----|-----|-----|-----|-----|-----|----|------|--|
| | | | 100 | 200 | 201 | 202 | 300 | 400 | 500 | 503 | 601 | 602 | 612 | 630 | | | | |
| RB | 90 | 80 | 169 | 181 | 187 | 199 | 210 | 223 | 251 | 295 | 356 | 392 | 431 | 510 | 24 | 26 | | |
| RB | 100 | | 178 | 191 | 198 | 211 | 223 | 238 | 271 | 317 | 376 | 414 | 455 | 538 | 25 | 27 | | |
| RB | 120 | | 196 | 214 | 222 | 238 | 254 | 271 | 310 | 374 | 465 | 512 | 563 | 665 | 27 | 29 | | |
| RB | 135 | | 205 | 222 | 232 | 250 | 267 | 287 | 334 | 402 | 483 | 531 | 584 | 690 | 29 | 31 | | |

**BAJO RINCON
ANGULAR**

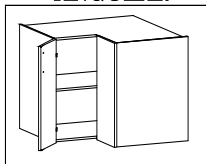

| REF. | ANCHO | ALTO | TARIFA | | | | | | | | | | | | BL. | | ANT. | |
|------------|-----------------|------|--------|-----|-----|-----|-----|-----|-----|-----|-----|-----|-----|-----|-----|----|------|--|
| | | | 100 | 200 | 201 | 202 | 300 | 400 | 500 | 503 | 601 | 602 | 612 | 630 | | | | |
| RBA | 90x 90 | | 258 | 269 | 284 | 295 | 306 | 314 | 346 | 440 | 474 | 521 | 574 | 678 | 38 | 45 | | |
| RBA | 100x 100 | | 290 | 301 | 320 | 334 | 347 | 353 | 407 | 484 | 528 | 581 | 639 | 756 | 39 | 46 | | |

**BOTELLERO PANERO
CROMO - FRENO**

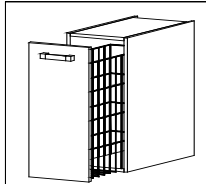

| REF. | ANCHO | ALTO | TARIFA | | | | | | | | | | | | BL. | | ANT. | |
|------------|-----------|-----------|--------|-----|-----|-----|-----|-----|-----|-----|-----|-----|-----|-----|-----|----|------|--|
| | | | 100 | 200 | 201 | 202 | 300 | 400 | 500 | 503 | 601 | 602 | 612 | 630 | | | | |
| BB | 15 | 80 | 236 | 242 | 244 | 248 | 251 | 254 | 265 | 299 | 335 | 368 | 405 | 479 | 5 | 8 | | |
| BBP | 30 | | 275 | 280 | 282 | 286 | 290 | 295 | 309 | 336 | 372 | 410 | 451 | 532 | 7 | 12 | | |
| BBP | 40 | | 289 | 295 | 298 | 303 | 307 | 314 | 333 | 353 | 393 | 432 | 475 | 562 | 9 | 14 | | |

TERMINAL BAJO

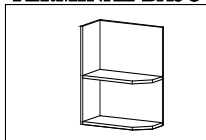

| REF. | ANCHO | ALTO | 100 | 200 | 201 | 202 | 300 | 400 | 500 | 503 | 601 | 611 | 612 | 630 |
|-----------|-----------|-----------|-----|-----|-----|-----|-----|-----|-----|-----|-----|-----|-----|-----|
| TB | 30 | 80 | 96 | 108 | 117 | 130 | 143 | 164 | 192 | 218 | 210 | 231 | 231 | 231 |

TERM.BAJO PUERTA

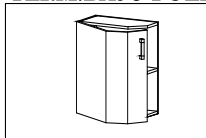

| REF. | ANCHO | ALTO | 100 | 200 | 201 | 202 | 300 | 400 | 500 | 503 | 601 | 611 | 612 | 630 | BL. | ANT. |
|------------|-----------|-----------|-----|-----|-----|-----|-----|-----|-----|-----|-----|-----|-----|-----|-----|------|
| TBP | 30 | 80 | 187 | 209 | 230 | 239 | 249 | 266 | 301 | 395 | 509 | 560 | 616 | 729 | 10 | 16 |

BAJOS CON CAJON METALICO

TARIFA

| | REF. | ANCHO | ALTO | 100 | 200 | 201 | 202 | 300 | 400 | 500 | 503 | 601 | 602 | 612 | 630 |
|--|------|-------|------|-----|-----|-----|-----|-----|-----|-----|-----|-----|-----|-----|-----|
| | B1CM | 25 | 70 | 116 | 124 | 127 | 132 | 136 | 140 | 151 | 201 | 220 | 242 | 266 | 315 |
| | B1CM | 30 | | 120 | 128 | 130 | 135 | 140 | 144 | 154 | 205 | 224 | 246 | 271 | 320 |
| | B1CM | 35 | | 124 | 132 | 135 | 140 | 145 | 150 | 162 | 211 | 232 | 255 | 281 | 332 |
| | B1CM | 40 | | 128 | 137 | 140 | 146 | 151 | 157 | 169 | 216 | 240 | 264 | 290 | 343 |
| | B1CM | 45 | | 136 | 145 | 148 | 155 | 161 | 167 | 181 | 227 | 253 | 278 | 306 | 362 |
| | B1CM | 50 | | 139 | 150 | 153 | 160 | 167 | 174 | 189 | 234 | 260 | 286 | 315 | 372 |
| | B1CM | 60 | 1P | 149 | 159 | 163 | 171 | 179 | 187 | 208 | 256 | 281 | 309 | 340 | 402 |

1 PUERTA 1 CAJON MET.

| | REF. | ANCHO | ALTO | 100 | 200 | 201 | 202 | 300 | 400 | 500 | 503 | 601 | 602 | 612 | 630 |
|--|------|-------|------|-----|-----|-----|-----|-----|-----|-----|-----|-----|-----|-----|-----|
| | B2CM | 60 | 70 | 186 | 202 | 207 | 217 | 226 | 234 | 253 | 356 | 388 | 427 | 469 | 555 |
| | B2CM | 70 | | 196 | 212 | 218 | 229 | 239 | 248 | 269 | 369 | 404 | 444 | 489 | 578 |
| | B2CM | 80 | | 204 | 222 | 229 | 241 | 252 | 262 | 286 | 382 | 421 | 463 | 509 | 602 |
| | B2CM | 90 | | 215 | 233 | 240 | 253 | 265 | 277 | 306 | 398 | 440 | 484 | 532 | 629 |
| | B2CM | 100 | | 223 | 243 | 251 | 265 | 278 | 291 | 323 | 412 | 457 | 503 | 553 | 654 |

2 PUERTA 2 CAJON MET.

BAJOS CAJON FRENO

| | REF. | ANCHO | ALTO | 100 | 200 | 201 | 202 | 300 | 400 | 500 | 503 | 601 | 602 | 612 | 630 |
|--|------|-------|------|-----|-----|-----|-----|-----|-----|-----|-----|-----|-----|-----|-----|
| | B1CA | 25 | 70 | 153 | 161 | 163 | 168 | 173 | 177 | 187 | 238 | 258 | 284 | 312 | 369 |
| | B1CA | 30 | | 153 | 164 | 167 | 172 | 176 | 180 | 191 | 241 | 262 | 288 | 317 | 375 |
| | B1CA | 35 | | 156 | 169 | 172 | 177 | 182 | 187 | 199 | 247 | 269 | 296 | 325 | 385 |
| | B1CA | 40 | | 161 | 173 | 177 | 183 | 188 | 193 | 207 | 253 | 278 | 306 | 336 | 398 |
| | B1CA | 45 | | 164 | 182 | 185 | 192 | 198 | 204 | 218 | 264 | 291 | 320 | 352 | 416 |
| | B1CA | 50 | | 173 | 187 | 191 | 198 | 204 | 211 | 227 | 271 | 299 | 329 | 362 | 428 |
| | B1CA | 60 | 1P | 177 | 197 | 201 | 209 | 217 | 225 | 245 | 294 | 319 | 351 | 386 | 456 |

1 PUERTA 1 CAJON FRENO

| | REF. | ANCHO | ALTO | 100 | 200 | 201 | 202 | 300 | 400 | 500 | 503 | 601 | 602 | 612 | 630 |
|--|------|-------|------|-----|-----|-----|-----|-----|-----|-----|-----|-----|-----|-----|-----|
| | B2CA | 60 | 70 | 259 | 274 | 280 | 290 | 299 | 307 | 327 | 429 | 463 | 509 | 560 | 662 |
| | B2CA | 70 | | 270 | 285 | 291 | 302 | 312 | 321 | 344 | 442 | 479 | 527 | 580 | 685 |
| | B2CA | 80 | | 278 | 296 | 302 | 314 | 325 | 336 | 360 | 455 | 497 | 547 | 601 | 711 |
| | B2CA | 90 | | 289 | 307 | 314 | 327 | 339 | 351 | 380 | 472 | 516 | 568 | 624 | 738 |
| | B2CA | 100 | | 298 | 318 | 326 | 340 | 353 | 366 | 397 | 487 | 534 | 587 | 646 | 764 |

2 PUERTA 2 CAJON FRENO

BAJOS CAJON METAL

| | REF. | ANCHO | ALTO | 100 | 200 | 201 | 202 | 300 | 400 | 500 | 503 | 601 | 602 | 612 | 630 |
|--|------|-------|------|-----|-----|-----|-----|-----|-----|-----|-----|-----|-----|-----|-----|
| | BTCM | 25 | 70 | 180 | 193 | 197 | 204 | 210 | 215 | 221 | 308 | 284 | 310 | 326 | 357 |
| | BTCM | 30 | | 185 | 198 | 202 | 209 | 216 | 220 | 227 | 313 | 290 | 316 | 332 | 363 |
| | BTCM | 35 | | 192 | 205 | 209 | 217 | 224 | 229 | 237 | 322 | 309 | 322 | 338 | 370 |
| | BTCM | 40 | | 200 | 216 | 220 | 229 | 237 | 242 | 249 | 333 | 324 | 340 | 357 | 391 |
| | BTCM | 45 | | 212 | 228 | 233 | 242 | 250 | 257 | 265 | 353 | 348 | 352 | 370 | 405 |
| | BTCM | 50 | | 217 | 236 | 242 | 251 | 260 | 267 | 274 | 361 | 362 | 368 | 386 | 423 |
| | BTCM | 60 | | 232 | 251 | 258 | 269 | 279 | 287 | 296 | 378 | 384 | 393 | 413 | 452 |

4 CAJONES MET.

| | REF. | ANCHO | ALTO | 100 | 200 | 201 | 202 | 300 | 400 | 500 | 503 | 601 | 602 | 612 | 630 |
|--|-------|-------|------|-----|-----|-----|-----|-----|-----|-----|-----|-----|-----|-----|-----|
| | BTC5M | 25 | 70 | 209 | 225 | 229 | 237 | 245 | 249 | 260 | 367 | 349 | 371 | 390 | 427 |
| | BTC5M | 30 | | 209 | 231 | 235 | 243 | 251 | 255 | 266 | 373 | 356 | 378 | 397 | 435 |
| | BTC5M | 35 | | 215 | 239 | 243 | 252 | 260 | 265 | 278 | 383 | 378 | 384 | 403 | 442 |
| | BTC5M | 40 | | 223 | 251 | 256 | 265 | 274 | 279 | 292 | 395 | 396 | 406 | 426 | 467 |
| | BTC5M | 45 | | 231 | 265 | 270 | 280 | 289 | 296 | 311 | 420 | 417 | 419 | 440 | 482 |
| | BTC5M | 50 | | 245 | 274 | 280 | 291 | 301 | 308 | 322 | 429 | 430 | 439 | 461 | 505 |
| | BTC5M | 60 | | 251 | 291 | 298 | 310 | 321 | 329 | 348 | 448 | 454 | 468 | 491 | 538 |

5 CAJONES MET.

BAJOS CAJON FRENO

| | REF. | ANCHO | ALTO | 100 | 200 | 201 | 202 | 300 | 400 | 500 | 503 | 601 | 602 | 612 | 630 |
|--|------|-------|------|-----|-----|-----|-----|-----|-----|-----|-----|-----|-----|-----|-----|
| | BTCa | 25 | 70 | 334 | 347 | 351 | 358 | 365 | 369 | 376 | 462 | 448 | 464 | 487 | 534 |
| | BTCa | 30 | | 340 | 353 | 356 | 363 | 370 | 374 | 381 | 467 | 455 | 470 | 494 | 541 |
| | BTCa | 35 | | 347 | 360 | 364 | 372 | 379 | 384 | 392 | 477 | 474 | 477 | 501 | 549 |
| | BTCa | 40 | | 356 | 372 | 376 | 384 | 392 | 398 | 405 | 488 | 490 | 496 | 521 | 570 |
| | BTCa | 45 | | 368 | 384 | 389 | 398 | 407 | 413 | 421 | 509 | 508 | 508 | 533 | 584 |
| | BTCa | 50 | | 375 | 394 | 399 | 409 | 418 | 425 | 432 | 519 | 520 | 525 | 551 | 604 |
| | BTCa | 60 | | 392 | 411 | 417 | 428 | 438 | 447 | 456 | 537 | 543 | 552 | 580 | 635 |

4 CAJONES FRENO

| | REF. | ANCHO | ALTO | 100 | 200 | 201 | 202 | 300 | 400 | 500 | 503 | 601 | 602 | 612 | 630 |
|--|-------|-------|------|-----|-----|-----|-----|-----|-----|-----|-----|-----|-----|-----|-----|
| | BTC5a | 25 | 70 | 402 | 418 | 422 | 430 | 437 | 442 | 453 | 559 | 542 | 564 | 592 | 649 |
| | BTC5a | 30 | | 408 | 424 | 428 | 436 | 443 | 448 | 459 | 566 | 548 | 570 | 599 | 656 |
| | BTC5a | 35 | | 416 | 432 | 437 | 445 | 453 | 458 | 472 | 577 | 572 | 578 | 607 | 665 |
| | BTC5a | 40 | | 426 | 445 | 450 | 459 | 468 | 474 | 487 | 590 | 590 | 601 | 631 | 691 |
| | BTC5a | 45 | | 441 | 460 | 466 | 476 | 485 | 491 | 506 | 615 | 613 | 615 | 646 | 707 |
| | BTC5a | 50 | | 449 | 472 | 478 | 488 | 498 | 505 | 519 | 627 | 627 | 636 | 668 | 731 |
| | BTC5a | 60 | | 467 | 490 | 497 | 509 | 520 | 528 | 547 | 647 | 654 | 667 | 700 | 767 |

5 CAJONES FRENO

BAJOS

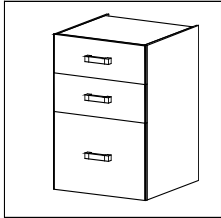
VERD. 2 CAJONES
METALICOS

TARIFA

| REF. | ANCHO | ALTO | 100 | 200 | 201 | 202 | 300 | 400 | 500 | 503 | 601 | 602 | 612 | 630 |
|------|-------|------|-----|-----|-----|-----|-----|-----|-----|-----|-----|-----|-----|-----|
| BVM | 40 | 70 | 196 | 209 | 213 | 220 | 227 | 233 | 238 | 302 | 343 | 379 | 398 | 436 |
| BVM | 45 | | 206 | 219 | 224 | 232 | 239 | 246 | 253 | 320 | 360 | 392 | 412 | 451 |
| BVM | 50 | | 214 | 229 | 234 | 243 | 251 | 258 | 265 | 334 | 373 | 408 | 428 | 469 |
| BVM | 60 | | 231 | 246 | 252 | 262 | 271 | 279 | 290 | 359 | 394 | 434 | 456 | 499 |

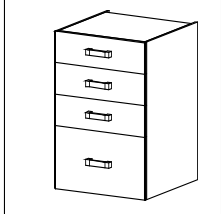
VERD. 3 CAJONES
METALICOS

| REF. | ANCHO | ALTO | 100 | 200 | 201 | 202 | 300 | 400 | 500 | 503 | 601 | 602 | 612 | 630 |
|------|-------|------|-----|-----|-----|-----|-----|-----|-----|-----|-----|-----|-----|-----|
| BV3M | 40 | 70 | 223 | 240 | 244 | 253 | 261 | 266 | 272 | 354 | 400 | 442 | 464 | 508 |
| BV3M | 45 | | 235 | 252 | 257 | 266 | 275 | 281 | 289 | 378 | 421 | 456 | 479 | 524 |
| BV3M | 50 | | 244 | 263 | 269 | 279 | 288 | 295 | 303 | 393 | 437 | 475 | 499 | 546 |
| BV3M | 60 | | 262 | 282 | 288 | 299 | 309 | 318 | 331 | 423 | 462 | 505 | 530 | 581 |

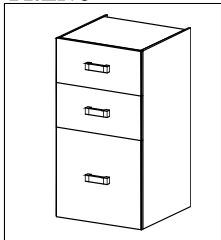
VERD. 2 CAJONES
FRENO

| REF. | ANCHO | ALTO | 100 | 200 | 201 | 202 | 300 | 400 | 500 | 503 | 601 | 602 | 612 | 630 |
|------|-------|------|-----|-----|-----|-----|-----|-----|-----|-----|-----|-----|-----|-----|
| BVA | 40 | 70 | 315 | 329 | 333 | 341 | 349 | 356 | 363 | 426 | 457 | 514 | 540 | 591 |
| BVA | 45 | | 327 | 340 | 345 | 354 | 362 | 369 | 379 | 445 | 476 | 528 | 554 | 607 |
| BVA | 50 | | 333 | 348 | 353 | 362 | 370 | 377 | 384 | 443 | 486 | 537 | 564 | 618 |
| BVA | 60 | | 351 | 366 | 371 | 381 | 390 | 399 | 410 | 478 | 507 | 553 | 581 | 636 |
| BVA | 70 | | 390 | 393 | 400 | 411 | 421 | 431 | 450 | 561 | 578 | 649 | 681 | 746 |
| BVA | 80 | | 408 | 412 | 419 | 431 | 442 | 454 | 476 | 625 | 612 | 675 | 709 | 776 |
| BVA | 90 | | 432 | 435 | 443 | 456 | 469 | 482 | 508 | 687 | 649 | 703 | 738 | 808 |
| BVA | 100 | | 451 | 455 | 464 | 478 | 492 | 506 | 538 | 737 | 700 | 748 | 785 | 860 |
| BVA | 120 | | 486 | 491 | 501 | 518 | 534 | 551 | 596 | 801 | 765 | 803 | 843 | 923 |

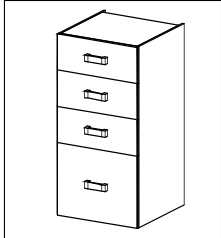
VERD. 3 CAJONES
FRENO

| REF. | ANCHO | ALTO | 100 | 200 | 201 | 202 | 300 | 400 | 500 | 503 | 601 | 602 | 612 | 630 |
|------|-------|------|-----|-----|-----|-----|-----|-----|-----|-----|-----|-----|------|------|
| BV3A | 40 | 70 | 381 | 398 | 403 | 411 | 419 | 425 | 430 | 513 | 560 | 600 | 630 | 690 |
| BV3A | 45 | | 394 | 411 | 416 | 425 | 434 | 440 | 449 | 537 | 578 | 615 | 646 | 707 |
| BV3A | 50 | | 404 | 423 | 429 | 438 | 447 | 455 | 463 | 553 | 590 | 635 | 667 | 730 |
| BV3A | 60 | | 423 | 442 | 449 | 460 | 470 | 478 | 491 | 583 | 635 | 666 | 699 | 766 |
| BV3A | 70 | | 474 | 476 | 484 | 496 | 507 | 517 | 536 | 694 | 713 | 793 | 833 | 912 |
| BV3A | 80 | | 494 | 497 | 506 | 519 | 532 | 543 | 565 | 769 | 763 | 831 | 873 | 956 |
| BV3A | 90 | | 522 | 526 | 535 | 549 | 563 | 576 | 602 | 840 | 811 | 867 | 910 | 997 |
| BV3A | 100 | | 545 | 549 | 559 | 574 | 589 | 604 | 634 | 898 | 870 | 917 | 963 | 1055 |
| BV3A | 120 | | 586 | 591 | 602 | 620 | 638 | 655 | 698 | 972 | 930 | 985 | 1034 | 1133 |

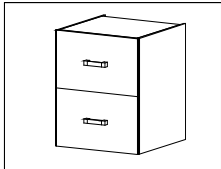
CACEROLERO
METALICO

| REF. | ANCHO | ALTO | 100 | 200 | 201 | 202 | 300 | 400 | 500 | 503 | 601 | 602 | 612 | 630 |
|------|-------|------|-----|-----|-----|-----|-----|-----|-----|-----|-----|-----|-----|-----|
| BCCM | 40 | 70 | 180 | 189 | 193 | 199 | 205 | 211 | 224 | 256 | 361 | 402 | 422 | 462 |
| BCCM | 45 | | 188 | 198 | 201 | 208 | 215 | 221 | 237 | 270 | 371 | 416 | 437 | 478 |
| BCCM | 50 | | 197 | 207 | 212 | 219 | 226 | 233 | 251 | 289 | 381 | 430 | 452 | 495 |
| BCCM | 60 | | 213 | 223 | 228 | 236 | 244 | 253 | 276 | 318 | 404 | 453 | 476 | 521 |

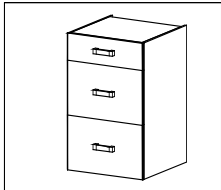
CACEROLERO
1 CAJON METALICO

| REF. | ANCHO | ALTO | 100 | 200 | 201 | 202 | 300 | 400 | 500 | 503 | 601 | 602 | 612 | 630 |
|-------|-------|------|-----|-----|-----|-----|-----|-----|-----|-----|-----|-----|-----|-----|
| BCCCM | 40 | 70 | 213 | 227 | 231 | 238 | 245 | 251 | 259 | 308 | 423 | 471 | 495 | 542 |
| BCCCM | 45 | | 224 | 237 | 242 | 250 | 257 | 264 | 275 | 330 | 436 | 487 | 511 | 560 |
| BCCCM | 50 | | 233 | 249 | 253 | 262 | 270 | 277 | 289 | 349 | 449 | 504 | 529 | 580 |
| BCCCM | 60 | | 251 | 266 | 271 | 281 | 290 | 299 | 316 | 386 | 474 | 531 | 558 | 611 |

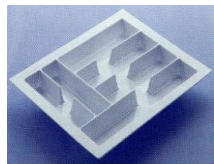

| | | |
|----------|------------------|----|
| I.CUB30 | CUBERTERO DE 30 | 10 |
| I.CUB35 | CUBERTERO DE 35 | 11 |
| I.CUB40 | CUBERTERO DE 40 | 12 |
| I.CUB45 | CUBERTERO DE 45 | 13 |
| I.CUB50 | CUBERTERO DE 50 | 13 |
| I.CUB60 | CUBERTERO DE 60 | 15 |
| I.CUB60 | CUBERTERO DE 70 | 45 |
| I.CUB60 | CUBERTERO DE 80 | 47 |
| I.CUB90 | CUBERTERO DE 90 | 48 |
| I.CUB100 | CUBERTERO DE 100 | 52 |
| I.CUB120 | CUBERTERO DE 120 | 56 |

**BAJOS
CACEROLERO
FRENO**
TARIFA

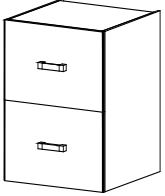
|  | REF. | ANCHO | ALTO | 100 | 200 | 201 | 202 | 300 | 400 | 500 | 503 | 601 | 602 | 612 | 630 |
|--|------|-------|------|-----|-----|-----|-----|-----|-----|-----|-----|-----|-----|-----|-----|
| | BCCA | 40 | 70 | 256 | 266 | 269 | 276 | 282 | 287 | 301 | 333 | 437 | 479 | 503 | 551 |
| BCCA | 45 | 266 | 275 | 279 | 286 | 292 | 298 | 315 | 347 | 449 | 493 | 518 | 567 | | |
| BCCA | 50 | 273 | 284 | 288 | 295 | 302 | 309 | 327 | 365 | 458 | 506 | 531 | 582 | | |
| BCCA | 60 | 288 | 298 | 303 | 312 | 320 | 328 | 351 | 394 | 480 | 528 | 554 | 607 | | |
| BCCA | 70 | 316 | 319 | 324 | 334 | 343 | 353 | 393 | 457 | 488 | 539 | 566 | 620 | | |
| BCCA | 80 | 333 | 336 | 342 | 353 | 363 | 374 | 420 | 522 | 514 | 566 | 594 | 651 | | |
| BCCA | 90 | 350 | 354 | 361 | 373 | 384 | 396 | 448 | 587 | 557 | 582 | 611 | 669 | | |
| BCCA | 100 | 367 | 371 | 379 | 391 | 403 | 418 | 482 | 660 | 650 | 682 | 716 | 784 | | |
| BCCA | 120 | 396 | 401 | 410 | 425 | 439 | 456 | 547 | 743 | 711 | 729 | 765 | 838 | | |

**CACEROLERO
1 CAJON FRENO**

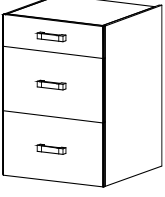
|  | REF. | ANCHO | ALTO | 100 | 200 | 201 | 202 | 300 | 400 | 500 | 503 | 601 | 602 | 612 | 630 |
|--|-------|-------|------|-----|-----|-----|-----|-----|-----|-----|-----|-----|------|-----|-----|
| | BCCCA | 40 | 70 | 331 | 345 | 349 | 356 | 363 | 369 | 387 | 426 | 541 | 589 | 618 | 677 |
| BCCCA | 45 | 343 | 356 | 361 | 369 | 376 | 383 | 404 | 449 | 555 | 606 | 636 | 697 | | |
| BCCCA | 50 | 352 | 367 | 372 | 380 | 388 | 396 | 417 | 467 | 568 | 622 | 653 | 715 | | |
| BCCCA | 60 | 368 | 383 | 389 | 399 | 408 | 417 | 443 | 504 | 591 | 649 | 681 | 746 | | |
| BCCCA | 70 | 407 | 410 | 417 | 428 | 438 | 448 | 476 | 596 | 642 | 678 | 712 | 780 | | |
| BCCCA | 80 | 427 | 430 | 437 | 449 | 461 | 473 | 504 | 668 | 674 | 727 | 763 | 836 | | |
| BCCCA | 90 | 449 | 453 | 461 | 474 | 487 | 500 | 536 | 739 | 732 | 750 | 788 | 863 | | |
| BCCCA | 100 | 469 | 473 | 482 | 496 | 510 | 525 | 570 | 822 | 818 | 834 | 876 | 959 | | |
| BCCCA | 120 | 505 | 510 | 520 | 537 | 553 | 570 | 636 | 917 | 883 | 901 | 946 | 1036 | | |

**CACEROLERO FRENO
CAJON INTERIOR**

|  | REF. | ANCHO | ALTO | 100 | 200 | 201 | 202 | 300 | 400 | 500 | 503 | 601 | 602 | 612 | 630 |
|--|--------|-------|------|-----|-----|-----|-----|-----|-----|-----|-----|-----|------|-----|-----|
| | BCCCLA | 40 | 70 | 331 | 345 | 349 | 356 | 363 | 369 | 387 | 426 | 541 | 589 | 618 | 677 |
| BCCCLA | 45 | 343 | 356 | 361 | 369 | 376 | 383 | 404 | 449 | 555 | 606 | 636 | 697 | | |
| BCCCLA | 50 | 352 | 367 | 372 | 380 | 388 | 396 | 417 | 467 | 568 | 622 | 653 | 715 | | |
| BCCCLA | 60 | 368 | 383 | 389 | 399 | 408 | 417 | 443 | 504 | 591 | 649 | 681 | 746 | | |
| BCCCLA | 70 | 407 | 410 | 417 | 428 | 438 | 448 | 476 | 596 | 642 | 678 | 712 | 780 | | |
| BCCCLA | 80 | 427 | 430 | 437 | 449 | 461 | 473 | 504 | 668 | 674 | 727 | 763 | 836 | | |
| BCCCLA | 90 | 449 | 453 | 461 | 474 | 487 | 500 | 536 | 739 | 732 | 750 | 788 | 863 | | |
| BCCCLA | 100 | 469 | 473 | 482 | 496 | 510 | 525 | 570 | 822 | 818 | 834 | 876 | 959 | | |
| BCCCLA | 120 | 505 | 510 | 520 | 537 | 553 | 570 | 636 | 917 | 883 | 901 | 946 | 1036 | | |

**SEM.COL.HORNO-MICRO
CON CAJON ABAJO**

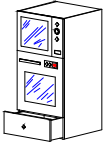
|  | REF. | ALTO | 100 | 200 | 201 | 202 | 300 | 400 | 500 | 503 | 601 | 602 | 612 | 630 |
|--|----------|------|-----|-----|-----|-----|-----|-----|-----|-----|-----|-----|-----|-----|
| | CHMCM 60 | 122 | 199 | 204 | 206 | 210 | 213 | 217 | 224 | 248 | 310 | 334 | 351 | 384 |
| 1 CAJON METALICO | | | | | | | | | | | | | | |
| CHMCA 60 | 122 | 236 | 242 | 244 | 248 | 251 | 254 | 262 | 286 | 347 | 372 | 391 | 428 | |
| 1 CAJON FRENO | | | | | | | | | | | | | | |

**SEM.COL.HORNO-MICRO
CON CACEROLERO ABAJO**

|  | REF. | ALTO | 100 | 200 | 201 | 202 | 300 | 400 | 500 | 503 | 601 | 602 | 612 | 630 |
|--|-----------|------|-----|-----|-----|-----|-----|-----|-----|-----|-----|-----|-----|-----|
| | CHMCCM 60 | 135 | 241 | 247 | 249 | 253 | 258 | 263 | 271 | 300 | 375 | 404 | 424 | 465 |
| 1 CACEROLERO METALICO | | | | | | | | | | | | | | |
| CHMCCA 60 | 135 | 286 | 293 | 295 | 299 | 304 | 307 | 317 | 346 | 420 | 450 | 473 | 518 | |
| 1 CACEROLERO FRENO | | | | | | | | | | | | | | |

**SEMI COL. HORNO
CON PUERTAS ABAJO**

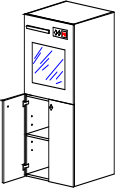
|  | REF. | ALTO | 100 | 200 | 201 | 202 | 300 | 400 | 500 | 503 | 601 | 602 | 612 | 630 |
|--|-------|--------|-----|-----|-----|-----|-----|-----|-----|-----|-----|-----|-----|-----|
| | CH 60 | 135 1P | 178 | 185 | 189 | 197 | 204 | 212 | 240 | 268 | 300 | 340 | 357 | 391 |
| 1 PUERTA | | | | | | | | | | | | | | |
| CH 60 | 135 | 193 | 204 | 209 | 217 | 225 | 234 | 257 | 312 | 368 | 419 | 440 | 482 | |
| 2 PUERTAS | | | | | | | | | | | | | | |

**HORNO SOBRECIMERA
PUERTAS ARRIBA**

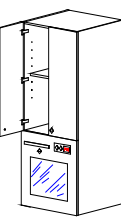
|  | REF. | ANCHO | ALTO | 100 | 200 | 201 | 202 | 300 | 400 | 500 | 503 | 601 | 602 | 612 | 630 |
|--|------|--------|--------|-----|-----|-----|-----|-----|-----|-----|-----|-----|-----|-----|-----|
| | CSH | 60 | 127 1P | 187 | 194 | 198 | 206 | 214 | 222 | 252 | 281 | 315 | 357 | 375 | 411 |
| CSH | 60 | 147 1P | 223 | 232 | 237 | 246 | 255 | 266 | 301 | 336 | 378 | 428 | 450 | 493 | |
| 1 PUERTA | | | | | | | | | | | | | | | |
| CSH | 60 | 127 | 202 | 214 | 219 | 227 | 236 | 245 | 269 | 327 | 386 | 440 | 462 | 506 | |
| CSH | 60 | 147 | 240 | 254 | 260 | 270 | 280 | 292 | 321 | 390 | 464 | 528 | 554 | 607 | |
| 2 PUERTAS | | | | | | | | | | | | | | | |

**BAJOS
CACEROLERO
FRENO**

TARIFA

0 1
INCR. INCR.

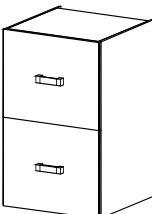
| REF. | ANCHO | ALTO | 100 | 200 | 201 | 202 | 300 | 400 | 500 | 503 | 601 | 602 | 612 | 630 | C.19 | C.19 |
|--|-------|------|-----|-----|-----|-----|-----|-----|-----|-----|-----|-----|-----|-----|------|------|
| | | | | | | | | | | | | | | | BL. | ANT. |
|  BCCCA 40 80 | 40 | 80 | 274 | 285 | 288 | 295 | 302 | 307 | 325 | 360 | 472 | 517 | 543 | 595 | 8 | 13 |
| BCCCA 45 | 45 | | 285 | 294 | 299 | 305 | 312 | 319 | 340 | 375 | 485 | 532 | 559 | 612 | 9 | 14 |
| BCCCA 50 | 50 | | 292 | 304 | 308 | 316 | 323 | 331 | 353 | 394 | 495 | 546 | 574 | 628 | 9 | 15 |
| BCCCA 60 | 60 | | 308 | 319 | 324 | 333 | 342 | 351 | 379 | 426 | 518 | 570 | 599 | 656 | 10 | 16 |
| BCCCA 70 | 70 | | 338 | 341 | 347 | 357 | 367 | 378 | 424 | 494 | 527 | 582 | 611 | 669 | 12 | 19 |
| BCCCA 80 | 80 | | 356 | 360 | 366 | 377 | 388 | 400 | 454 | 564 | 555 | 611 | 642 | 703 | 14 | 23 |
| BCCCA 90 | 90 | | 375 | 379 | 386 | 399 | 411 | 424 | 484 | 634 | 602 | 629 | 660 | 723 | 16 | 25 |
| BCCCA 100 | 100 | | 393 | 397 | 406 | 418 | 431 | 447 | 521 | 713 | 702 | 737 | 773 | 847 | 18 | 27 |
| BCCCA 120 | 120 | | 424 | 429 | 439 | 454 | 470 | 488 | 591 | 802 | 768 | 787 | 827 | 905 | 20 | 29 |

**CACEROLERO
1 CAJON FRENO**

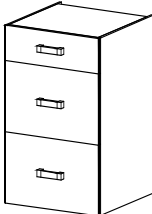
| REF. | ANCHO | ALTO | 100 | 200 | 201 | 202 | 300 | 400 | 500 | 503 | 601 | 602 | 612 | 630 | BL. | ANT. |
|--|-------|------|-----|-----|-----|-----|-----|-----|-----|-----|-----|-----|------|------|-----|------|
| | | | | | | | | | | | | | | | BL. | ANT. |
|  BCCCA 40 80 | 40 | 80 | 354 | 369 | 373 | 381 | 388 | 395 | 418 | 460 | 584 | 636 | 668 | 732 | 8 | 13 |
| BCCCA 45 | 45 | | 367 | 381 | 386 | 394 | 402 | 410 | 436 | 485 | 599 | 654 | 687 | 753 | 9 | 14 |
| BCCCA 50 | 50 | | 377 | 393 | 398 | 407 | 415 | 424 | 450 | 504 | 613 | 672 | 705 | 773 | 9 | 15 |
| BCCCA 60 | 60 | | 394 | 410 | 416 | 426 | 437 | 446 | 478 | 544 | 638 | 701 | 736 | 806 | 10 | 16 |
| BCCCA 70 | 70 | | 435 | 439 | 446 | 457 | 469 | 479 | 514 | 644 | 693 | 732 | 769 | 842 | 12 | 19 |
| BCCCA 80 | 80 | | 457 | 460 | 468 | 480 | 493 | 506 | 544 | 721 | 728 | 785 | 824 | 903 | 14 | 23 |
| BCCCA 90 | 90 | | 480 | 485 | 493 | 507 | 521 | 535 | 579 | 798 | 791 | 810 | 851 | 932 | 16 | 25 |
| BCCCA 100 | 100 | | 502 | 506 | 516 | 531 | 546 | 562 | 616 | 888 | 883 | 901 | 946 | 1036 | 18 | 27 |
| BCCCA 120 | 120 | | 540 | 546 | 556 | 574 | 592 | 610 | 687 | 990 | 954 | 973 | 1022 | 1119 | 20 | 29 |

**CACEROLERO FRENO
CAJON INTERIOR**

| REF. | ANCHO | ALTO | 100 | 200 | 201 | 202 | 300 | 400 | 500 | 503 | 601 | 602 | 612 | 630 | BL. | ANT. |
|--|-------|------|-----|-----|-----|-----|-----|-----|-----|-----|-----|-----|------|------|-----|------|
| | | | | | | | | | | | | | | | BL. | ANT. |
|  BCCCIA 40 80 | 40 | 80 | 354 | 369 | 373 | 381 | 388 | 395 | 418 | 460 | 584 | 636 | 668 | 732 | 8 | 13 |
| BCCCIA 45 | 45 | | 367 | 381 | 386 | 394 | 402 | 410 | 436 | 485 | 599 | 654 | 687 | 753 | 9 | 14 |
| BCCCIA 50 | 50 | | 377 | 393 | 398 | 407 | 415 | 424 | 450 | 504 | 613 | 672 | 705 | 773 | 9 | 15 |
| BCCCIA 60 | 60 | | 394 | 410 | 416 | 426 | 437 | 446 | 478 | 544 | 638 | 701 | 736 | 806 | 10 | 16 |
| BCCCIA 70 | 70 | | 435 | 439 | 446 | 457 | 469 | 479 | 514 | 644 | 693 | 732 | 769 | 842 | 12 | 19 |
| BCCCIA 80 | 80 | | 457 | 460 | 468 | 480 | 493 | 506 | 544 | 721 | 728 | 785 | 824 | 903 | 14 | 23 |
| BCCCIA 90 | 90 | | 480 | 485 | 493 | 507 | 521 | 535 | 579 | 798 | 791 | 810 | 851 | 932 | 16 | 25 |
| BCCCIA 100 | 100 | | 502 | 506 | 516 | 531 | 546 | 562 | 616 | 888 | 883 | 901 | 946 | 1036 | 18 | 27 |
| BCCCIA 120 | 120 | | 540 | 546 | 556 | 574 | 592 | 610 | 687 | 990 | 954 | 973 | 1022 | 1119 | 20 | 29 |

**SEM.COL.HORNO-MICRO
CON CACER.ABAJO
DE 135 DE ALTURA**

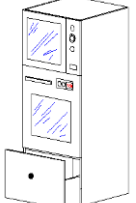
| REF. | ALTO | 100 | 200 | 201 | 202 | 300 | 400 | 500 | 503 | 601 | 602 | 612 | 630 | BL. | ANT. |
|--|------|-----|-----|-----|-----|-----|-----|-----|-----|-----|-----|-----|-----|-----|------|
| | | | | | | | | | | | | | | BL. | ANT. |
|  CHMCCM 60 | 140 | 258 | 264 | 267 | 271 | 276 | 281 | 293 | 324 | 405 | 436 | 458 | 502 | 18 | 26 |
| 1 CACEROLERO METALICO | | | | | | | | | | | | | | | |
| REF. | ALTO | 100 | 200 | 201 | 202 | 300 | 400 | 500 | 503 | 601 | 602 | 612 | 630 | BL. | ANT. |
| CHMCCA 60 | 140 | 306 | 313 | 316 | 320 | 325 | 329 | 342 | 374 | 453 | 486 | 510 | 559 | 18 | 26 |
| 1 CACEROLERO FRENO | | | | | | | | | | | | | | | |

**SEMI COL. HORNO
CON PUERTAS ABAJO**

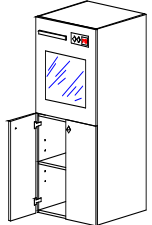
| REF. | ALTO | 100 | 200 | 201 | 202 | 300 | 400 | 500 | 503 | 601 | 602 | 612 | 630 | BL. | ANT. |
|---|--------|-----|-----|-----|-----|-----|-----|-----|-----|-----|-----|-----|-----|-----|------|
| | | | | | | | | | | | | | | BL. | ANT. |
|  CH 60 1 PUERTA | 140 1F | 190 | 198 | 202 | 210 | 218 | 227 | 259 | 289 | 324 | 367 | 386 | 422 | 19 | 27 |
| REF. | ALTO | 100 | 200 | 201 | 202 | 300 | 400 | 500 | 503 | 601 | 602 | 612 | 630 | BL. | ANT. |
| CH 60 2 PUERTAS | 140 | 207 | 218 | 224 | 232 | 241 | 250 | 278 | 337 | 397 | 453 | 475 | 520 | 19 | 27 |

**HORNO
SOBREENCIMERA
PUERTAS ARRIBA**

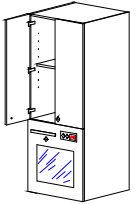
| REF. | ANCHO | ALTO | 100 | 200 | 201 | 202 | 300 | 400 | 500 | 503 | 601 | 602 | 612 | 630 | BL. | ANT. |
|--|-------|--------|-----|-----|-----|-----|-----|-----|-----|-----|-----|-----|-----|-----|-----|------|
| | | | | | | | | | | | | | | | BL. | ANT. |
|  CSH 60 1 PUERTA | 60 | 147 1P | 238 | 248 | 253 | 263 | 273 | 284 | 325 | 363 | 408 | 463 | 486 | 532 | 22 | 30 |
| REF. | ANCHO | ALTO | 100 | 200 | 201 | 202 | 300 | 400 | 500 | 503 | 601 | 602 | 612 | 630 | BL. | ANT. |
| CSH 60 2 PUERTAS | 60 | 147 | 257 | 272 | 278 | 289 | 300 | 312 | 346 | 421 | 501 | 570 | 599 | 656 | 22 | 30 |

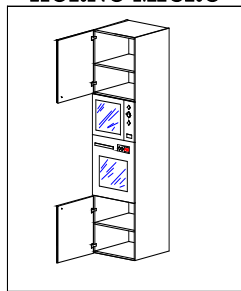
**COLUMNAS
HORNO MICRO**

**TARIFA
EN CASO DE SER SOLO HORNO DEBE DE ESPECIFICARSE**

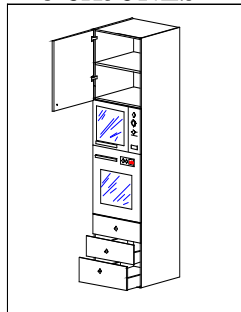
| REF. | ANCHO | ALTO | 100 | 200 | 201 | 202 | 300 | 400 | 500 | 503 | 601 | 602 | 612 | 630 |
|------------|-----------|---------------|-----|-----|-----|-----|-----|-----|-----|-----|-----|-----|-----|-----|
| CHM | 60 | 200 1P | 270 | 283 | 291 | 306 | 320 | 338 | 394 | 449 | 498 | 548 | 575 | 630 |
| REF. | ANCHO | ALTO | 100 | 200 | 201 | 202 | 300 | 400 | 500 | 503 | 601 | 602 | 612 | 630 |
| CHM | 60 | 220 1P | 295 | 316 | 326 | 343 | 360 | 377 | 430 | 495 | 542 | 596 | 626 | 686 |

UNA PUERTA ABAJO + UNA PUERTA ARRIBA
**HORNO MICRO
3 CAJONES**

| REF. | ANCHO | ALTO | 100 | 200 | 201 | 202 | 300 | 400 | 500 | 503 | 601 | 602 | 612 | 630 |
|--------------|-----------|---------------|-----|-----|-----|-----|-----|-----|-----|-----|-----|-----|-----|-----|
| CHMCM | 60 | 200 1P | 363 | 385 | 394 | 411 | 427 | 443 | 478 | 577 | 637 | 701 | 736 | 806 |
| CHMCM | 60 | 220 1P | 381 | 403 | 413 | 431 | 449 | 469 | 511 | 620 | 678 | 746 | 783 | 858 |

3 CAJONES METALICOS + UNA PUERTA ARRIBA

| REF. | ANCHO | ALTO | 100 | 200 | 201 | 202 | 300 | 400 | 500 | 503 | 601 | 602 | 612 | 630 |
|--------------|-----------|---------------|-----|-----|-----|-----|-----|-----|-----|-----|-----|-----|-----|------|
| CHMCA | 60 | 200 1P | 491 | 513 | 524 | 542 | 560 | 579 | 622 | 730 | 785 | 864 | 907 | 993 |
| CHMCA | 60 | 220 1P | 504 | 526 | 536 | 554 | 572 | 591 | 634 | 743 | 801 | 881 | 925 | 1013 |

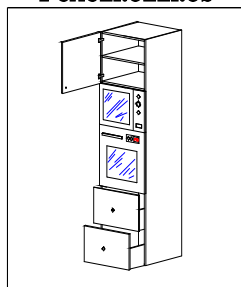
3 CAJONES FRENO + UNA PUERTA ARRIBA
**HORNO MICRO
2 CACEROLEROS**

| REF. | ANCHO | ALTO | 100 | 200 | 201 | 202 | 300 | 400 | 500 | 503 | 601 | 602 | 612 | 630 |
|---------------|-----------|---------------|-----|-----|-----|-----|-----|-----|-----|-----|-----|-----|-----|-----|
| CHMCCM | 60 | 200 1P | 362 | 377 | 385 | 397 | 409 | 422 | 453 | 520 | 627 | 690 | 724 | 793 |
| CHMCCM | 60 | 220 1P | 378 | 395 | 404 | 419 | 433 | 448 | 491 | 567 | 668 | 735 | 772 | 845 |

2 CACEROLEROS METALICOS + UNA PUERTA ARRIBA

| REF. | ANCHO | ALTO | 100 | 200 | 201 | 202 | 300 | 400 | 500 | 503 | 601 | 602 | 612 | 630 |
|---------------|-----------|---------------|-----|-----|-----|-----|-----|-----|-----|-----|-----|-----|-----|-----|
| CHMCCA | 60 | 200 1P | 437 | 453 | 460 | 472 | 484 | 497 | 528 | 595 | 703 | 773 | 812 | 889 |
| CHMCCA | 60 | 220 1P | 454 | 470 | 479 | 494 | 508 | 523 | 567 | 642 | 743 | 817 | 858 | 940 |

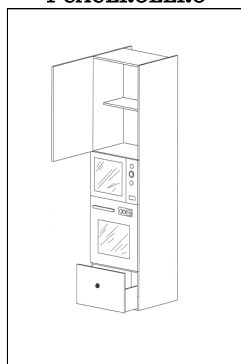
2 CACEROLEROS FRENO + UNA PUERTA ARRIBA
**HORNO MICRO
1 CACEROLERO**

| REF. | ANCHO | ALTO | 100 | 200 | 201 | 202 | 300 | 400 | 500 | 503 | 601 | 602 | 612 | 630 |
|---------------|-----------|---------------|-----|-----|-----|-----|-----|-----|-----|-----|-----|-----|-----|-----|
| CHMC1M | 60 | 200 1P | 316 | 330 | 338 | 351 | 365 | 380 | 424 | 485 | 563 | 619 | 650 | 712 |
| CHMC1M | 60 | 220 1P | 337 | 356 | 365 | 381 | 397 | 413 | 461 | 531 | 605 | 666 | 699 | 765 |

1 CACEROLERO METALICO + UNA PUERTA ARRIBA

| REF. | ANCHO | ALTO | 100 | 200 | 201 | 202 | 300 | 400 | 500 | 503 | 601 | 602 | 612 | 630 |
|---------------|-----------|---------------|-----|-----|-----|-----|-----|-----|-----|-----|-----|-----|-----|-----|
| CHMC1A | 60 | 200 1P | 354 | 368 | 376 | 389 | 402 | 418 | 461 | 522 | 601 | 661 | 694 | 760 |
| CHMC1A | 60 | 220 1P | 375 | 393 | 403 | 418 | 434 | 450 | 499 | 569 | 643 | 707 | 742 | 813 |

1 CACEROLERO FRENO + UNA PUERTA ARRIBA

**COLUMNAS
HORNO MICRO**

**TARIFA
EN CASO DE SER SOLO HORNO DEBE DE ESPECIFICARSE**

0 1

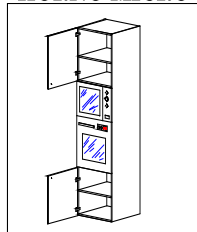

| REF. | ANCHO | ALTO | 100 | 200 | 201 | 202 | 300 | 400 | 500 | 503 | 601 | 602 | 612 | 630 | INCR. | |
|------------|-----------|---------------|-----|-----|-----|-----|-----|-----|-----|-----|-----|-----|-----|-----|-----------|------------|
| | | | | | | | | | | | | | | | C.19 | C.19 |
| CHM | 60 | 205 1P | 284 | 297 | 306 | 321 | 336 | 355 | 418 | 476 | 528 | 581 | 610 | 668 | BL | ANT |
| | | | | | | | | | | | | | | | 36 | 46 |
| CHM | 60 | 225 1P | 310 | 332 | 342 | 360 | 378 | 396 | 456 | 525 | 575 | 632 | 664 | 727 | BL | ANT |
| | | | | | | | | | | | | | | | 47 | 58 |

UNA PUERTA ABAJO + UNA PUERTA ARRIBA

**HORNO MICRO
3 CAJONES**

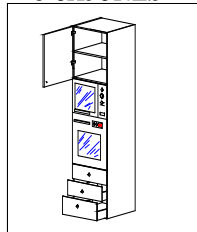

| REF. | ANCHO | ALTO | 100 | 200 | 201 | 202 | 300 | 400 | 500 | 503 | 601 | 602 | 612 | 630 | BL | | ANT | |
|--------------|-----------|---------------|-----|-----|-----|-----|-----|-----|-----|-----|-----|-----|-----|-----|----|----|-----|----|
| | | | | | | | | | | | | | | | 32 | 42 | 43 | 54 |
| CHMCM | 60 | 205 1P | 378 | 400 | 410 | 427 | 444 | 461 | 502 | 606 | 669 | 736 | 773 | 846 | | | | |
| CHMCM | 60 | 225 1P | 396 | 419 | 430 | 448 | 467 | 488 | 537 | 651 | 712 | 783 | 822 | 901 | | | | |

3 CAJONES METALICOS + UNA PUERTA ARRIBA

| REF. | ANCHO | ALTO | 100 | 200 | 201 | 202 | 300 | 400 | 500 | 503 | 601 | 602 | 612 | 630 | BL | | ANT | |
|--------------|-----------|---------------|-----|-----|-----|-----|-----|-----|-----|-----|-----|-----|-----|------|----|----|-----|----|
| | | | | | | | | | | | | | | | 32 | 42 | 43 | 54 |
| CHMCA | 60 | 205 1P | 511 | 534 | 545 | 564 | 582 | 602 | 653 | 767 | 824 | 907 | 952 | 1043 | | | | |
| CHMCA | 60 | 225 1P | 524 | 547 | 557 | 576 | 595 | 615 | 666 | 780 | 841 | 925 | 971 | 1064 | | | | |

3 CAJONES FRENO + UNA PUERTA ARRIBA

**HORNO MICRO
2 CACEROLEROS**

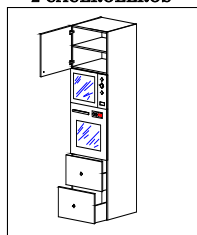

| REF. | ANCHO | ALTO | 100 | 200 | 201 | 202 | 300 | 400 | 500 | 503 | 601 | 602 | 612 | 630 | BL | | ANT | |
|---------------|-----------|---------------|-----|-----|-----|-----|-----|-----|-----|-----|-----|-----|-----|-----|----|----|-----|----|
| | | | | | | | | | | | | | | | 32 | 42 | 43 | 54 |
| CHMCCM | 60 | 205 1P | 376 | 392 | 400 | 413 | 425 | 439 | 476 | 546 | 658 | 724 | 760 | 833 | | | | |
| CHMCCM | 60 | 225 1P | 393 | 411 | 420 | 435 | 450 | 466 | 516 | 595 | 701 | 772 | 810 | 887 | | | | |

2 CACEROLEROS METALICOS + UNA PUERTA ARRIBA

| REF. | ANCHO | ALTO | 100 | 200 | 201 | 202 | 300 | 400 | 500 | 503 | 601 | 602 | 612 | 630 | BL | | ANT | |
|---------------|-----------|---------------|-----|-----|-----|-----|-----|-----|-----|-----|-----|-----|-----|-----|----|----|-----|----|
| | | | | | | | | | | | | | | | 32 | 42 | 43 | 54 |
| CHMCCA | 60 | 205 1P | 454 | 471 | 478 | 491 | 503 | 517 | 554 | 625 | 738 | 812 | 853 | 934 | | | | |
| CHMCCA | 60 | 225 1P | 472 | 489 | 498 | 513 | 528 | 544 | 595 | 674 | 780 | 858 | 901 | 987 | | | | |

2 CACEROLEROS FRENO + UNA PUERTA ARRIBA

**HORNO MICRO
1 CACEROLERO**

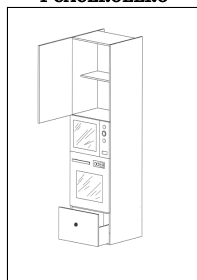

| REF. | ANCHO | ALTO | 100 | 200 | 201 | 202 | 300 | 400 | 500 | 503 | 601 | 602 | 612 | 630 | BL | | ANT | |
|---------------|-----------|------------|-----|-----|-----|-----|-----|-----|-----|-----|-----|-----|-----|-----|----|----|-----|----|
| | | | | | | | | | | | | | | | 32 | 42 | 43 | 54 |
| CHMC1M | 60 | 205 | 329 | 343 | 352 | 365 | 380 | 395 | 445 | 509 | 591 | 650 | 683 | 748 | | | | |
| CHMC1M | 60 | 225 | 350 | 370 | 380 | 396 | 413 | 430 | 484 | 558 | 635 | 693 | 734 | 803 | | | | |

1 CACEROLERO METALICO + UNA PUERTA ARRIBA

| REF. | ANCHO | ALTO | 100 | 200 | 201 | 202 | 300 | 400 | 500 | 503 | 601 | 602 | 612 | 630 | BL | | ANT | |
|---------------|-----------|------------|-----|-----|-----|-----|-----|-----|-----|-----|-----|-----|-----|-----|----|----|-----|----|
| | | | | | | | | | | | | | | | 32 | 42 | 43 | 54 |
| CHMC1A | 60 | 205 | 368 | 383 | 391 | 405 | 418 | 435 | 484 | 631 | 798 | 694 | 729 | 798 | | | | |
| CHMC1A | 60 | 225 | 390 | 409 | 419 | 435 | 451 | 468 | 524 | 675 | 854 | 742 | 779 | 854 | | | | |

1 CACEROLERO FRENO + UNA PUERTA ARRIBA

COLUMNAS ESCOBEROS

TARIFA

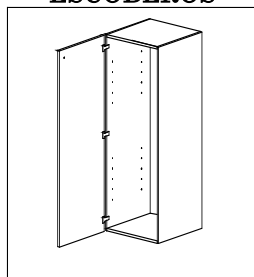

1 PUERTA

| REF. | ANCHO | ALTO | 100 | 200 | 201 | 202 | 300 | 400 | 500 | 503 | 601 | 602 | 612 | 630 |
|------|-------|------|-----|-----|-----|-----|-----|-----|-----|-----|-----|-----|-----|-----|
| CL | 25 | 122 | 149 | 157 | 161 | 165 | 169 | 176 | 199 | 294 | 274 | 301 | 332 | 392 |
| CL | 30 | | 153 | 162 | 166 | 171 | 176 | 184 | 212 | 295 | 276 | 304 | 334 | 395 |
| CL | 35 | | 157 | 165 | 170 | 177 | 183 | 192 | 226 | 307 | 284 | 312 | 344 | 406 |
| CL | 40 | | 165 | 174 | 179 | 187 | 194 | 205 | 243 | 321 | 295 | 325 | 357 | 422 |
| CL | 45 | | 170 | 178 | 184 | 193 | 201 | 214 | 257 | 331 | 303 | 333 | 367 | 433 |
| CL | 50 | | 177 | 185 | 192 | 202 | 212 | 225 | 273 | 344 | 318 | 350 | 385 | 455 |
| CL | 60 | 1P | 185 | 193 | 201 | 213 | 225 | 242 | 301 | 363 | 349 | 384 | 422 | 499 |

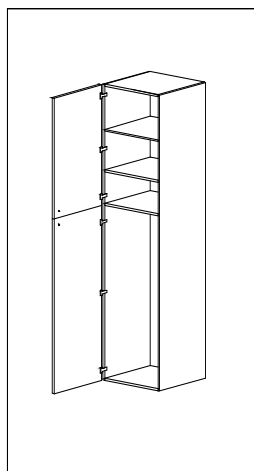

2 PUERTAS

| REF. | ANCHO | ALTO | 100 | 200 | 201 | 202 | 300 | 400 | 500 | 503 | 601 | 602 | 612 | 630 |
|------|-------|------|-----|-----|-----|-----|-----|-----|-----|-----|-----|-----|-----|-----|
| CL | 25 | 200 | 213 | 225 | 231 | 239 | 247 | 257 | 290 | 418 | 423 | 465 | 512 | 605 |
| CL | 30 | | 219 | 232 | 239 | 249 | 258 | 270 | 310 | 421 | 427 | 470 | 517 | 611 |
| CL | 35 | | 225 | 239 | 246 | 258 | 269 | 283 | 331 | 436 | 440 | 484 | 532 | 629 |
| CL | 40 | | 235 | 249 | 258 | 271 | 283 | 300 | 355 | 454 | 455 | 501 | 551 | 651 |
| CL | 45 | | 242 | 256 | 265 | 280 | 294 | 313 | 376 | 472 | 468 | 515 | 566 | 669 |
| CL | 50 | | 251 | 267 | 276 | 293 | 309 | 330 | 401 | 494 | 490 | 539 | 593 | 701 |
| CL | 60 | 1P | 265 | 280 | 292 | 312 | 331 | 356 | 443 | 533 | 539 | 593 | 652 | 771 |

| REF. | ANCHO | ALTO | 100 | 200 | 201 | 202 | 300 | 400 | 500 | 503 | 601 | 602 | 612 | 630 |
|------|-------|------|-----|-----|-----|-----|-----|-----|-----|-----|-----|-----|-----|-----|
| CL | 25 | 220 | 225 | 238 | 245 | 254 | 262 | 274 | 308 | 450 | 451 | 496 | 546 | 645 |
| CL | 30 | | 232 | 246 | 254 | 264 | 274 | 288 | 330 | 454 | 456 | 502 | 552 | 652 |
| CL | 35 | | 239 | 254 | 262 | 274 | 286 | 302 | 354 | 472 | 470 | 517 | 569 | 672 |
| CL | 40 | | 250 | 265 | 274 | 288 | 302 | 320 | 380 | 494 | 487 | 536 | 589 | 696 |
| CL | 45 | | 257 | 272 | 282 | 298 | 314 | 335 | 403 | 517 | 501 | 551 | 606 | 716 |
| CL | 50 | | 268 | 284 | 295 | 313 | 330 | 353 | 430 | 543 | 526 | 579 | 636 | 752 |
| CL | 60 | 1P | 283 | 299 | 312 | 333 | 354 | 382 | 477 | 577 | 582 | 640 | 704 | 832 |

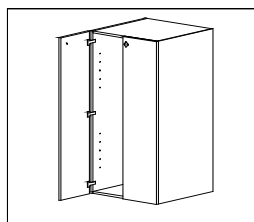

2 PUERTAS

| REF. | ANCHO | ALTO | 100 | 200 | 201 | 202 | 300 | 400 | 500 | 503 | 601 | 602 | 612 | 630 |
|------|-------|------|-----|-----|-----|-----|-----|-----|-----|-----|-----|-----|-----|-----|
| CL | 60 | 122 | 209 | 226 | 235 | 245 | 255 | 271 | 327 | 494 | 444 | 488 | 537 | 635 |
| CL | 70 | | 217 | 234 | 244 | 257 | 269 | 288 | 355 | 517 | 460 | 506 | 557 | 658 |
| CL | 80 | | 231 | 249 | 259 | 274 | 289 | 311 | 388 | 543 | 480 | 528 | 581 | 686 |
| CL | 90 | | 241 | 258 | 270 | 288 | 305 | 329 | 416 | 564 | 497 | 547 | 601 | 711 |
| CL | 100 | | 257 | 274 | 287 | 307 | 326 | 353 | 450 | 591 | 528 | 581 | 639 | 755 |

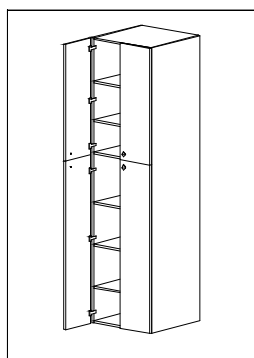

4 PUERTAS

| REF. | ANCHO | ALTO | 100 | 200 | 201 | 202 | 300 | 400 | 500 | 503 | 601 | 602 | 612 | 630 |
|------|-------|------|-----|-----|-----|-----|-----|-----|-----|-----|-----|-----|------|------|
| CL | 60 | 200 | 308 | 336 | 349 | 368 | 386 | 411 | 491 | 712 | 706 | 777 | 854 | 1010 |
| CL | 70 | | 322 | 349 | 364 | 386 | 408 | 437 | 533 | 742 | 733 | 806 | 887 | 1048 |
| CL | 80 | | 344 | 372 | 389 | 415 | 440 | 473 | 583 | 781 | 765 | 842 | 926 | 1094 |
| CL | 90 | | 358 | 386 | 404 | 434 | 463 | 500 | 626 | 819 | 792 | 871 | 958 | 1133 |
| CL | 100 | | 377 | 407 | 427 | 460 | 492 | 533 | 675 | 862 | 836 | 920 | 1012 | 1195 |

| REF. | ANCHO | ALTO | 100 | 200 | 201 | 202 | 300 | 400 | 500 | 503 | 601 | 602 | 612 | 630 |
|------|-------|------|-----|-----|-----|-----|-----|-----|-----|-----|-----|-----|------|------|
| CL | 60 | 220 | 327 | 357 | 372 | 393 | 413 | 440 | 525 | 772 | 756 | 832 | 915 | 1081 |
| CL | 70 | | 342 | 372 | 388 | 413 | 437 | 469 | 572 | 809 | 785 | 864 | 950 | 1123 |
| CL | 80 | | 366 | 397 | 415 | 443 | 471 | 507 | 627 | 855 | 821 | 903 | 993 | 1174 |
| CL | 90 | | 382 | 412 | 432 | 464 | 496 | 537 | 674 | 902 | 850 | 935 | 1029 | 1216 |
| CL | 100 | | 404 | 435 | 457 | 492 | 527 | 573 | 726 | 954 | 900 | 990 | 1089 | 1287 |

FRIGO INTEGRABLE

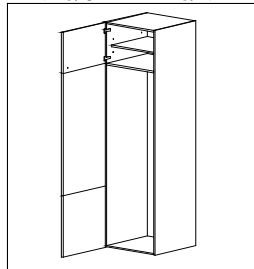

1 PUERTA

| REF. | ANCHO | ALTO | 100 | 200 | 201 | 202 | 300 | 400 | 500 | 503 | 601 | 602 | 612 | 630 |
|------|-------|--------|-----|-----|-----|-----|-----|-----|-----|-----|-----|-----|-----|-----|
| CFI | 60 | 200 1P | 295 | 312 | 325 | 347 | 369 | 397 | 494 | 595 | 604 | 664 | 730 | 863 |

| REF. | ANCHO | ALTO | 100 | 200 | 201 | 202 | 300 | 400 | 500 | 503 | 601 | 602 | 612 | 630 |
|------|-------|--------|-----|-----|-----|-----|-----|-----|-----|-----|-----|-----|-----|-----|
| CFI | 60 | 220 1P | 315 | 333 | 348 | 371 | 395 | 426 | 532 | 644 | 652 | 717 | 789 | 932 |

**COLUMNAS
DESPENSERO**

TARIFA

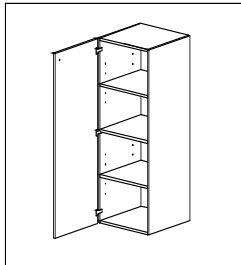

1 PUERTA

| REF. | ANCHO | ALTO | 100 | 200 | 201 | 202 | 300 | 400 | 500 | 503 | 601 | 602 | 612 | 630 |
|------|-------|------|-----|-----|-----|-----|-----|-----|-----|-----|-----|-----|-----|-----|
| CD | 25 | 122 | 156 | 164 | 168 | 172 | 176 | 183 | 207 | 301 | 283 | 311 | 342 | 405 |
| CD | 30 | | 161 | 170 | 174 | 179 | 184 | 192 | 220 | 303 | 286 | 315 | 346 | 409 |
| CD | 35 | | 166 | 174 | 179 | 186 | 192 | 201 | 235 | 316 | 295 | 325 | 357 | 422 |
| CD | 40 | | 175 | 184 | 189 | 197 | 204 | 215 | 253 | 331 | 308 | 339 | 373 | 440 |
| CD | 45 | | 180 | 189 | 194 | 203 | 212 | 224 | 268 | 342 | 317 | 349 | 384 | 453 |
| CD | 50 | | 188 | 197 | 203 | 213 | 223 | 237 | 285 | 355 | 333 | 366 | 403 | 476 |
| CD | 60 | 1P | 198 | 207 | 214 | 227 | 239 | 255 | 314 | 376 | 368 | 405 | 445 | 526 |

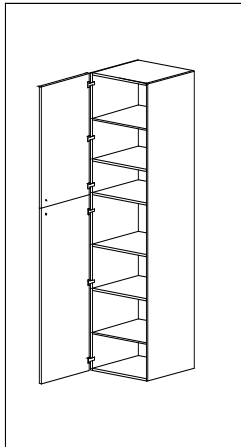

2 PUERTAS

| REF. | ANCHO | ALTO | 100 | 200 | 201 | 202 | 300 | 400 | 500 | 503 | 601 | 602 | 612 | 630 |
|------|-------|------|-----|-----|-----|-----|-----|-----|-----|-----|-----|-----|-----|-----|
| CD | 25 | 200 | 221 | 234 | 240 | 248 | 255 | 266 | 298 | 426 | 433 | 476 | 524 | 619 |
| CD | 30 | | 228 | 242 | 249 | 258 | 267 | 280 | 319 | 430 | 438 | 482 | 530 | 626 |
| CD | 35 | | 236 | 249 | 257 | 268 | 279 | 293 | 341 | 446 | 453 | 498 | 548 | 648 |
| CD | 40 | | 246 | 261 | 269 | 282 | 294 | 311 | 366 | 465 | 469 | 516 | 567 | 671 |
| CD | 45 | | 254 | 268 | 277 | 292 | 306 | 325 | 388 | 484 | 483 | 531 | 584 | 691 |
| CD | 50 | | 264 | 279 | 289 | 305 | 321 | 342 | 413 | 506 | 507 | 558 | 613 | 725 |
| CD | 60 | 1P | 280 | 295 | 306 | 326 | 346 | 370 | 458 | 548 | 559 | 615 | 676 | 799 |

| REF. | ANCHO | ALTO | 100 | 200 | 201 | 202 | 300 | 400 | 500 | 503 | 601 | 602 | 612 | 630 |
|------|-------|------|-----|-----|-----|-----|-----|-----|-----|-----|-----|-----|-----|-----|
| CD | 25 | 220 | 233 | 247 | 253 | 262 | 271 | 282 | 317 | 459 | 462 | 508 | 559 | 661 |
| CD | 30 | | 241 | 256 | 263 | 274 | 284 | 297 | 340 | 463 | 468 | 515 | 566 | 669 |
| CD | 35 | | 249 | 264 | 272 | 285 | 297 | 313 | 364 | 483 | 483 | 531 | 584 | 691 |
| CD | 40 | | 261 | 276 | 285 | 299 | 313 | 331 | 391 | 505 | 501 | 551 | 606 | 716 |
| CD | 45 | | 270 | 284 | 294 | 310 | 326 | 347 | 415 | 529 | 517 | 569 | 626 | 739 |
| CD | 50 | | 281 | 297 | 308 | 326 | 343 | 366 | 443 | 556 | 543 | 597 | 657 | 776 |
| CD | 60 | 1P | 298 | 314 | 326 | 348 | 369 | 396 | 492 | 592 | 601 | 661 | 727 | 859 |

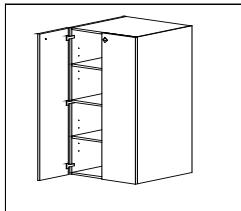

2 PUERTAS

| REF. | ANCHO | ALTO | 100 | 200 | 201 | 202 | 300 | 400 | 500 | 503 | 601 | 602 | 612 | 630 |
|------|-------|------|-----|-----|-----|-----|-----|-----|-----|-----|-----|-----|-----|-----|
| CD | 60 | 122 | 223 | 240 | 248 | 258 | 268 | 285 | 341 | 507 | 462 | 508 | 559 | 661 |
| CD | 70 | | 232 | 249 | 259 | 272 | 284 | 303 | 370 | 532 | 480 | 528 | 581 | 686 |
| CD | 80 | | 248 | 266 | 276 | 291 | 306 | 328 | 404 | 560 | 503 | 553 | 609 | 719 |
| CD | 90 | | 260 | 277 | 289 | 307 | 324 | 348 | 435 | 583 | 523 | 575 | 633 | 748 |
| CD | 100 | | 278 | 295 | 307 | 327 | 347 | 374 | 471 | 612 | 557 | 613 | 674 | 797 |

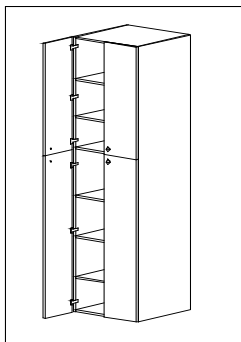

4 PUERTAS

| REF. | ANCHO | ALTO | 100 | 200 | 201 | 202 | 300 | 400 | 500 | 503 | 601 | 602 | 612 | 630 |
|------|-------|------|-----|-----|-----|-----|-----|-----|-----|-----|-----|-----|------|------|
| CD | 60 | 200 | 323 | 350 | 364 | 383 | 401 | 426 | 505 | 727 | 726 | 799 | 878 | 1038 |
| CD | 70 | | 338 | 365 | 380 | 403 | 425 | 454 | 549 | 758 | 754 | 829 | 912 | 1078 |
| CD | 80 | | 362 | 391 | 407 | 433 | 458 | 491 | 601 | 799 | 790 | 869 | 956 | 1130 |
| CD | 90 | | 378 | 406 | 424 | 454 | 483 | 520 | 646 | 839 | 819 | 901 | 991 | 1171 |
| CD | 100 | | 399 | 429 | 449 | 482 | 514 | 555 | 697 | 884 | 866 | 953 | 1048 | 1238 |

| REF. | ANCHO | ALTO | 100 | 200 | 201 | 202 | 300 | 400 | 500 | 503 | 601 | 602 | 612 | 630 |
|------|-------|------|-----|-----|-----|-----|-----|-----|-----|-----|-----|------|------|------|
| CD | 60 | 220 | 342 | 372 | 387 | 407 | 427 | 455 | 540 | 787 | 776 | 854 | 939 | 1110 |
| CD | 70 | | 358 | 388 | 404 | 429 | 453 | 485 | 588 | 825 | 807 | 888 | 976 | 1154 |
| CD | 80 | | 384 | 415 | 433 | 461 | 489 | 525 | 645 | 874 | 846 | 931 | 1024 | 1210 |
| CD | 90 | | 402 | 432 | 452 | 484 | 516 | 557 | 694 | 922 | 878 | 966 | 1062 | 1256 |
| CD | 100 | | 426 | 457 | 479 | 515 | 550 | 595 | 749 | 976 | 930 | 1023 | 1125 | 1330 |

TERMINAL COLUMNA

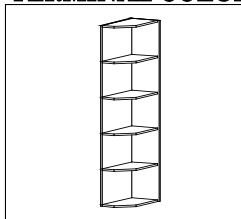

| REF. | ANCHO | ALTO | 100 | 200 | 201 | 202 | 300 | 400 | 500 | 503 | 601 | 602 | 612 | 630 |
|------|-------|------|-----|-----|-----|-----|-----|-----|-----|-----|-----|-----|-----|-----|
| TCL | 33 | 122 | 141 | 158 | 171 | 190 | 210 | 239 | 277 | 314 | 302 | 332 | 332 | 332 |
| TCL | 33 | 200 | 248 | 277 | 298 | 333 | 368 | 419 | 484 | 550 | 528 | 581 | 581 | 581 |
| TCL | 33 | 220 | 274 | 307 | 330 | 369 | 407 | 463 | 536 | 609 | 584 | 643 | 643 | 643 |

**COLUMNAS
DESPENSERO**

TARIFA

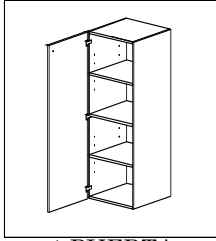

1 PUERTA

| REF. | ANCHO | ALTO | | | | | | | | | | | | 0 | | 1 | |
|------|-------|------|-----|-----|-----|-----|-----|-----|-----|-----|-----|-----|-----|-------|-------|------|--|
| | | | | | | | | | | | | | | INCR. | INCR. | | |
| | | | | | | | | | | | | | | C.19 | C.19 | | |
| CD | 25 | 127 | 100 | 200 | 201 | 202 | 300 | 400 | 500 | 503 | 601 | 602 | 612 | 630 | BL. | ANT. | |
| CD | 25 | 127 | 164 | 172 | 176 | 181 | 185 | 192 | 219 | 319 | 300 | 330 | 363 | 429 | 25 | 31 | |
| CD | 30 | | 169 | 179 | 183 | 188 | 193 | 202 | 233 | 321 | 303 | 333 | 367 | 434 | 25 | 32 | |
| CD | 35 | | 174 | 183 | 188 | 195 | 202 | 211 | 249 | 335 | 313 | 344 | 378 | 447 | 26 | 32 | |
| CD | 40 | | 184 | 193 | 198 | 206 | 214 | 226 | 268 | 351 | 326 | 359 | 395 | 467 | 26 | 33 | |
| CD | 45 | | 189 | 198 | 204 | 213 | 223 | 235 | 284 | 363 | 336 | 370 | 407 | 481 | 27 | 34 | |
| CD | 50 | | 197 | 207 | 213 | 224 | 234 | 249 | 302 | 376 | 353 | 388 | 427 | 505 | 27 | 35 | |
| CD | 60 | 1P | 208 | 217 | 225 | 238 | 251 | 268 | 333 | 399 | 390 | 429 | 472 | 558 | 29 | 36 | |

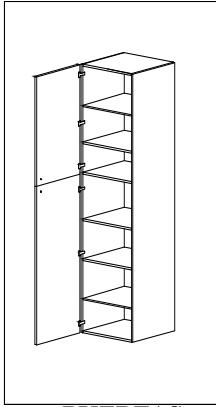

2 PUERTAS

| REF. | ANCHO | ALTO | | | | | | | | | | | | 0 | | 1 | |
|------|-------|------|-----|-----|-----|-----|-----|-----|-----|-----|-----|-----|-----|-----|------|------|--|
| | | | | | | | | | | | | | | BL. | ANT. | | |
| | | | | | | | | | | | | | | | | | |
| CD | 25 | 205 | 100 | 200 | 201 | 202 | 300 | 400 | 500 | 503 | 601 | 602 | 612 | 630 | BL. | ANT. | |
| CD | 25 | 205 | 232 | 246 | 252 | 260 | 268 | 279 | 316 | 452 | 459 | 505 | 555 | 656 | 39 | 47 | |
| CD | 30 | | 239 | 254 | 261 | 271 | 280 | 294 | 338 | 456 | 464 | 511 | 562 | 664 | 40 | 49 | |
| CD | 35 | | 248 | 261 | 270 | 281 | 293 | 308 | 361 | 473 | 480 | 528 | 581 | 687 | 41 | 50 | |
| CD | 40 | | 258 | 274 | 282 | 296 | 309 | 327 | 388 | 493 | 497 | 547 | 602 | 711 | 42 | 51 | |
| CD | 45 | | 267 | 281 | 291 | 306 | 321 | 341 | 411 | 513 | 512 | 563 | 619 | 732 | 43 | 52 | |
| CD | 50 | | 277 | 293 | 303 | 320 | 337 | 359 | 438 | 536 | 537 | 591 | 650 | 769 | 44 | 54 | |
| CD | 60 | 1P | 294 | 310 | 321 | 342 | 363 | 389 | 485 | 581 | 593 | 652 | 717 | 847 | 46 | 55 | |

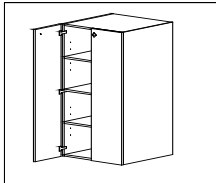

2 PUERTAS

| REF. | ANCHO | ALTO | | | | | | | | | | | | 0 | | 1 | |
|------|-------|------|-----|-----|-----|-----|-----|-----|-----|-----|-----|-----|-----|-----|------|------|--|
| | | | | | | | | | | | | | | BL. | ANT. | | |
| | | | | | | | | | | | | | | | | | |
| CD | 60 | 127 | 100 | 200 | 201 | 202 | 300 | 400 | 500 | 503 | 601 | 602 | 612 | 630 | BL. | ANT. | |
| CD | 60 | 127 | 234 | 252 | 260 | 271 | 281 | 299 | 361 | 537 | 490 | 539 | 593 | 700 | 29 | 36 | |
| CD | 70 | | 244 | 261 | 272 | 285 | 298 | 318 | 392 | 564 | 509 | 560 | 616 | 728 | 30 | 38 | |
| CD | 80 | | 260 | 279 | 290 | 306 | 321 | 344 | 428 | 594 | 533 | 586 | 645 | 762 | 31 | 39 | |
| CD | 90 | | 273 | 291 | 303 | 322 | 340 | 365 | 461 | 618 | 554 | 610 | 671 | 793 | 32 | 41 | |
| CD | 100 | | 292 | 310 | 322 | 343 | 364 | 393 | 499 | 649 | 590 | 649 | 714 | 844 | 33 | 42 | |

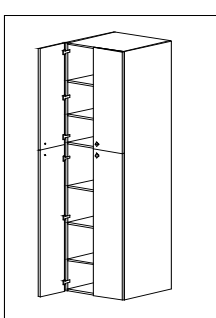

4 PUERTAS

| REF. | ANCHO | ANCHO | ALTO | | | | | | | | | | | | 0 | | 1 | |
|------|-------|-------|------|-----|-----|-----|-----|-----|-----|-----|-----|------|------|------|-----|------|---|--|
| | | | | | | | | | | | | | | | BL. | ANT. | | |
| | | | | | | | | | | | | | | | | | | |
| CD | 60 | 205 | 100 | 200 | 201 | 202 | 300 | 400 | 500 | 503 | 601 | 602 | 612 | 630 | BL. | ANT. | | |
| CD | 60 | 205 | 339 | 368 | 382 | 402 | 421 | 447 | 535 | 771 | 770 | 847 | 931 | 1100 | 46 | 55 | | |
| CD | 70 | | 355 | 383 | 399 | 423 | 446 | 477 | 582 | 803 | 799 | 879 | 967 | 1143 | 48 | 57 | | |
| CD | 80 | | 380 | 411 | 427 | 454 | 481 | 516 | 637 | 847 | 837 | 921 | 1013 | 1197 | 49 | 60 | | |
| CD | 90 | | 397 | 426 | 445 | 476 | 507 | 546 | 685 | 889 | 868 | 955 | 1050 | 1241 | 51 | 62 | | |
| CD | 100 | | 419 | 450 | 471 | 506 | 540 | 583 | 739 | 937 | 918 | 1010 | 1111 | 1313 | 53 | 64 | | |

TERMINAL COLUMNA

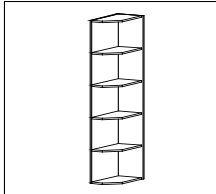





| REF. | ANCHO | ALTO | 100 | 200 | 201 | 202 | 300 | 400 | 500 | 503 | 601 | 602 | 612 | 630 |
|------|-------|------|-----|-----|-----|-----|-----|-----|-----|-----|-----|-----|-----|-----|
| TCL | 33 | 127 | 149 | 166 | 179 | 200 | 221 | 251 | 293 | 333 | 320 | 352 | 352 | 352 |
| TCL | 33 | 205 | 260 | 291 | 313 | 350 | 386 | 440 | 513 | 583 | 559 | 616 | 616 | 616 |
| TCL | 33 | 225 | 288 | 322 | 347 | 387 | 427 | 487 | 568 | 646 | 619 | 682 | 682 | 682 |





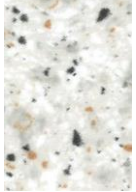
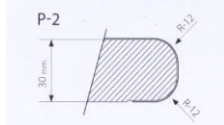
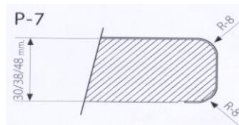

INCREMENTO POR COSTADO VISTO INCORPORADO EN EL MUEBLE

| REF. | ANCHO | ALTO | 100 | 200 | 201 | 202 | 300 | 400 | 500 | 503 | 601 | 602 | 612 | 630 |
|------|-------|------|-----|-----|-----|-----|-----|-----|-----|-----|-----|-----|-----|-----|
| ICB | 70 | 23 | 26 | 30 | 37 | 43 | 52 | 62 | 91 | 85 | 94 | 94 | 94 | 94 |
| ICB | 80 | 25 | 28 | 33 | 40 | 48 | 58 | 80 | 111 | 90 | 99 | 99 | 99 | 99 |
| ICB | 90 | 27 | 30 | 36 | 44 | 52 | 64 | 97 | 131 | 95 | 105 | 105 | 105 | 105 |
| ICB | 122 | 35 | 40 | 47 | 59 | 70 | 86 | 106 | 162 | 179 | 197 | 197 | 197 | 197 |
| ICB | 147 | 42 | 48 | 56 | 70 | 84 | 103 | 127 | 194 | 215 | 236 | 236 | 236 | 236 |
| ICB | 200 | 51 | 59 | 71 | 91 | 110 | 137 | 176 | 241 | 187 | 206 | 206 | 206 | 206 |
| ICB | 205 | 53 | 62 | 74 | 94 | 115 | 140 | 185 | 250 | 190 | 209 | 209 | 209 | 209 |
| ICB | 220 | 56 | 65 | 77 | 99 | 120 | 149 | 203 | 268 | 194 | 213 | 213 | 213 | 213 |
| ICB | 225 | 59 | 68 | 80 | 102 | 125 | 153 | 210 | 275 | 200 | 220 | 220 | 220 | 220 |

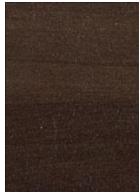

**INCREMENTO
POR COSTADO
VISTO FONDO -
58**

ENCIMERAS Y MOSTRADORES DE 3CM

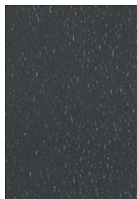
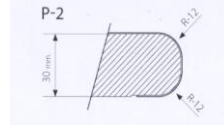
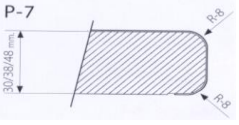
| REFERENCIA | | | GRUPO DE PRECIOS | ENCIMERA 63 | | MOSTRADOR 65 | MOSTRADOR 90 |
|--|---|---|---|-------------|--|--------------|--------------|
|  |  |  | | TIRA | TIRA | TIRA | TIRA |
| | | | | 180 | 360 | 360 | 360 |
| RGA-9620-BR | TRA-260-ST | 8001-TF | G1E2 | G1E1 | G1M651 | G1M901 | |
|  RGR-9640-BR | | |  OAS-278-ST | |  1907-MATE | | |
| <p>PERFIL 2</p> | | | <p>PERFIL 7</p> | | | | |
| | | | 1 | 67 | 119 | 203 | 243 |
| | | |  | |  | | |

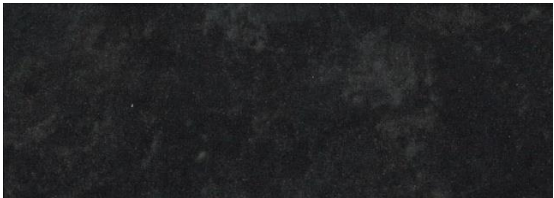
| REFERENCIA | | | | GRUPO DE PRECIOS | G2E2 | G2E1 | G2M651 | G2M901 | |
|---|---|---|---|--|------------|---|------------|---|--|
|  |  |  |  | | | | | | |
| | | | | PP-5564-BR | GLP-283-SL | DAV-442-SF | OXA-445-WX | | |
|  OXM-444-WX | | | |  GLR-244 | | | |  GLG-400-TF | |
| <p>PERFIL 2</p> | | | | <p>PERFIL 7</p> | | | | | |
| | | | | 2 | 76 | 133 | 232 | 281 | |
| | | | |  | |  | | | |

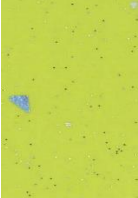
| REFERENCIA | GRUPO DE PRECIOS | G3E2 | G3E1 | G3M651 | G3M901 |
|---|------------------|-----------|------------|------------|------------|
|  | | | | | |
| PP-5568-BR | 3 | 84 | 147 | 279 | 349 |

| REFERENCIA | | | GRUPO DE PRECIOS | G4E2 | G4E1 | G4M651 | G4M901 |
|---|---|---|------------------|-----------|------------|------------|------------|
|  |  |  | | | | | |
| QUARZ-LIMA | QUARZ-BLANCO | QUARZ-NEGRO | 4 | 96 | 174 | 287 | 355 |

JUNTAS DE ALUMINIO 3 Y 4 CM

JT/JT4



JUNTA DE TERMINACION
8 PUNTOS

JU/JU4



JUNTA DE UNION
8 PUNTOS









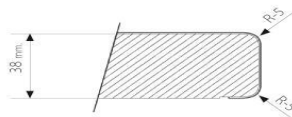





JE/JE4



JUNTA DE EMPALME
8 PUNTOS

ENCIMERAS Y MOSTRADORES DE 4CM







| REFERENCIA | GRUPO DE PRECIOS | ENCIMERA 63 | MOSTRADOR 65 | MOSTRADOR 90 |
|---|------------------|---------------------|-----------------------|-----------------------|
|  3091-PIETRA  CAT-178 | | TIRA 360 G6E1 | TIRA 360 G6M651 | TIRA 360 G1M901 |
| | 6 | 166 | 233 | 282 |
| PERFIL 1 | | | | |
| REFERENCIA | GRUPO DE PRECIOS | G7E1 | G7M651 | G7M901 |
|  LAR-770 | 7 | 178 | 248 | 300 |
| PERFIL 1 | | | | |
| REFERENCIA | GRUPO DE PRECIOS | G8E1 | G8M651 | G8M901 |
|  DAV-442  TRC-443  KMM-740  VEC-773 | 8 | 194 | 268 | 325 |
|  OXA-445  OXM-444  GLP-283  GLM-246 | | | | |
|  VEO-774 | | | | |
| PERFIL 1 | | | | |
| REFERENCIA | GRUPO DE PRECIOS | G7E1 | G7M651 | G7M901 |
|  F-3460 (NOVEDAD)  F-948 (NOVEDAD) | 9 | 237 | 322 | 390 |
| PERFIL 1 | | | | |

ENCIMERAS HIDROFUGAS DE 4CM

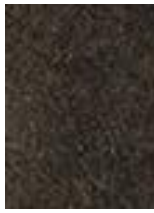

GRUESO 40 mm

| REFERENCIA | ENCIMERA DE 63 | |
|---|------------------|--------------------|
| | GRUPO DE PRECIOS | PUNTOS 410CM G10E1 |
|      | 10 | 204 |
| <p>H3332-ST10 ROBLE NEBR. H1145-ST10 ROBLE BARDOL. F633-ST15 METAL BRONCE. W980-ST2 BLANCO CAOLIN. F641-ST10 CHR MIX ANTRAC.</p>     | | |
| PERFIL POSTFORMADO | | |

| REFERENCIA | ENCIMERA DE 63 | |
|--|------------------|--------------------|
| | GRUPO DE PRECIOS | PUNTOS 410CM G11E1 |
|      | 11 | 234 |
| <p>F310-ST87 CERAMIC HERR. F311-ST87 CERAMIC ANTR. W1000-ST89 BLANCO PREMIUM. U999-ST89 NEGRO. U702-ST89 CACHEMIR.</p> | | |
| PERFIL RECTO | | |

| REFERENCIA | ENCIMERA DE 63 | |
|--|------------------|--------------------|
| | GRUPO DE PRECIOS | PUNTOS 410CM G12E1 |
|     | 12 | 602 |
| <p>H1180-ST37 R.HALIFAX NAT. H1181-ST37 R.HLIFAX TAB. H3309-ST28 R.GLADST. ARENA. H3325-ST28 R.GLADST, TAB.</p> | | |
| PERFIL RECTO DISEÑO PORO SINCRONIZADO | | |

COPETES

| COPETE CÓNCAVO | REF. | COLOR | PUNTOS |
|---|------|----------|------------|
| | | | TIRA 4 MTS |
|  | C1AL | ALUMINIO | 40 |
| | C1N | NEGRO | 40 |
| | C1B | BLANCO | 40 |
| | REF. | COLOR | TIRA 2 MTS |
| | C2AL | ALUMINIO | 20 |
| | C2N | NEGRO | 20 |
| | C2B | BLANCO | 20 |

| COPETE MINI | REF. | COLOR | PUNTOS |
|--|-------|----------|------------|
| | | | TIRA 4 MTS |
|  | CM1AL | ALUMINIO | 40 |
| | CM1N | NEGRO | 40 |
| | CM1B | BLANCO | 40 |
| | REF. | COLOR | TIRA 2 MTS |
| | CMAL | ALUMINIO | 20 |
| | CM2N | NEGRO | 20 |
| | CM2B | BLANCO | 20 |

| COPETE CUADRO | REF. | COLOR | PUNTOS |
|---|------|-----------|------------|
| | | | TIRA 4 MTS |
|  | CC1 | ANTRACITA | 40 |
| | REF. | COLOR | TIRA 2 MTS |
| | CC2 | ANTRACITA | 20 |
| | | | |

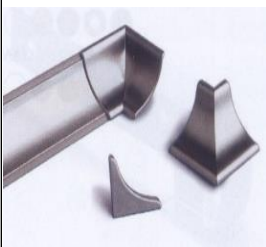
| | | |
|--|-----------------|---|
|  | TERMINAL | AL PASAR EL PEDIDO TENDREMOS QUE ESPECIFICAR LOS ACCESORIOS DE COPETE QUE NECESITEMOS, ASI COMO EL ACABADO. EL PRECIO ESTA INCLUIDO EN EL METRO LINEAL |
| | ESQUINA | |
| | RINCON | |

ZOCALOS

| ZOCALO PVC | REFERENCIA | H-15 | ACABADO | TIRA 4 MTS |
|--|------------|----------------------|-----------|------------|
|  | ZPA1AL | ZOCALO PVC ALTURA 15 | ALUMINIO | 44 |
| | ZPA1N | ZOCALO PVC ALTURA 15 | NEGRO | 44 |
| | ZPA1B | ZOCALO PVC ALTURA 15 | BLANCO | 44 |
| | ZPA1ANT | ZOCALO PVC ALTURA 15 | ANTRACITA | 44 |
| | REFERENCIA | H-15 | ACABADO | TIRA 2 MTS |
| | ZPA2AL | ZOCALO PVC ALTURA 15 | ALUMINIO | 27 |
| | ZPA2N | ZOCALO PVC ALTURA 15 | NEGRO | 27 |
| | ZPA2B | ZOCALO PVC ALTURA 15 | BLANCO | 27 |
| | ZPA2ANT | ZOCALO PVC ALTURA 15 | ANTRACITA | 27 |

| ZOCALO PVC | REFERENCIA | H-10 | ACABADO | TIRA 4 MTS |
|--|------------|----------------------|-----------|------------|
|  | ZPA101AL | ZOCALO PVC ALTURA 10 | ALUMINIO | 40 |
| | ZPA101N | ZOCALO PVC ALTURA 10 | NEGRO | 40 |
| | ZPA101B | ZOCALO PVC ALTURA 10 | BLANCO | 40 |
| | ZPA101ANT | ZOCALO PVC ALTURA 10 | ANTRACITA | 40 |
| | REFERENCIA | H-10 | ACABADO | TIRA 2 MTS |
| | ZPA102AL | ZOCALO PVC ALTURA 10 | ALUMINIO | 25 |
| | ZPA102N | ZOCALO PVC ALTURA 10 | NEGRO | 25 |
| | ZPA102B | ZOCALO PVC ALTURA 10 | BLANCO | 25 |
| | ZPA102ANT | ZOCALO PVC ALTURA 10 | ANTRACITA | 25 |

| ANGULO | REFERENCIA | H-15 | ACABADO | PUNTOS |
|---|------------|------------------------------|-----------|--------|
|  | RZPAL | ACCESORIO FLEXIBLE ALTURA 15 | ALUMINIO | 9 |
| | RZPAN | ACCESORIO FLEXIBLE ALTURA 15 | NEGRO | 9 |
| | RZPAB | ACCESORIO FLEXIBLE ALTURA 15 | BLANCO | 9 |
| | RZPANT | ACCESORIO FLEXIBLE ALTURA 15 | ANTRACITA | 9 |
| ANGULO | REFERENCIA | H-10 | ACABADO | PUNTOS |
|  | RZP10AL | ACCESORIO FLEXIBLE ALTURA 10 | ALUMINIO | 7 |
| | RZP10AN | ACCESORIO FLEXIBLE ALTURA 10 | NEGRO | 7 |
| | RZP10B | ACCESORIO FLEXIBLE ALTURA 10 | BLANCO | 7 |
| | RZP10ANT | ACCESORIO FLEXIBLE ALTURA 10 | ANTRACITA | 7 |

ZOCALOS

| ZOCALO ALUMINIO | REFERENCIA | H-15 | ACABADO | TIRA 4 MTS |
|--|------------|---------------------------|----------|------------|
|  | ZA1 | ZOCALO ALUMINIO ALTURA 15 | ALUMINIO | 82 |
| | | | | TIRA 2 MTS |
| | ZA2 | ZOCALO ALUMINIO ALTURA 15 | ALUMINIO | 47 |
| | | | | |
| ANGULOS | REFERENCIA | H-15 | ACABADO | PUNTOS |
|  | RZA | RINCON ZOCALO ALUMINIO | ALUMINIO | 9 |
| | EZA | ESQUINA ZOCALO ALUMINIO | ALUMINIO | 9 |

| ZOCALO MOD. PUERTA | REFERENCIA | H-15 | ACABADO | TIRA 2,70 MTS |
|--|------------|---|---------------|---------------|
|  | ZM1 | SUIZA, AUSTRIA, ALABAMA, TORONTO, BOSTON, CANADA, SIL | MALAMINA | 30 |
| | | | | TIRA 2,70 MTS |
| | ZM101 | SUIZA, AUSTRIA, ALABAMA, TORONTO, BOSTON, CANADA, SIL | MELAMINA | 27 |
| | | | | |
| | ZP1 | MIÑO, LUGO, LUXEMBURGO, DETROIT. | ESTRATIFICADO | 48 |
| | ZP101 | MIÑO, LUGO, LUXEMBURGO, DETROIT. | ESTRATIFICADO | 45 |
| | | | | |
| | ZPL1 | MOD:POLILAMINADOS | PVC | 54 |
| | ZPL101 | MOD:POLILAMINADOS | PVC | 50 |
| | ZL1 | MOD:LACADOS | LACA | 64 |
| | ZL101 | MOD:LACADOS | LACA | 60 |
| | ZB1 | MOD:MADERA | MADERA | 54 |
| | ZB101 | MOD:MADERA | MADERA | 50 |

| PERFIL ZOCALO | REFERENCIA | 19 MMS | | TIRA -360 |
|---|------------|--------------|--|-----------|
|  | PZ1 | TRANSPARENTE | | 9 |

PUERTAS Y FRENTE

DISEÑO PUERTAS

TARIFA

| REF. | ANCHO | ALTO | 100 | 200 | 201 | 202 | 300 | 400 | 500 | 502 | 503 | 601 | 602 | 612 | 630 |
|------|-------|------|-----|-----|-----|-----|-----|-----|-----|-----|-----|-----|-----|-----|-----|
| P | 25 | 42 | 24 | 25 | 36 | 35 | 35 | 39 | 51 | 67 | 71 | 71 | 78 | 86 | 102 |
| P | 30 | | 26 | 27 | 38 | 38 | 38 | 43 | 56 | 74 | 78 | 71 | 78 | 86 | 102 |
| P | 35 | | 28 | 30 | 41 | 41 | 41 | 47 | 60 | 79 | 84 | 77 | 84 | 93 | 109 |
| P | 40 | | 29 | 30 | 43 | 44 | 45 | 52 | 66 | 87 | 92 | 82 | 90 | 99 | 117 |
| P | 45 | | 30 | 31 | 44 | 46 | 48 | 55 | 70 | 93 | 98 | 87 | 96 | 106 | 125 |
| P | 50 | | 32 | 34 | 47 | 49 | 51 | 60 | 76 | 100 | 106 | 93 | 102 | 112 | 133 |
| P | 60 | | 35 | 37 | 51 | 54 | 57 | 67 | 84 | 111 | 118 | 104 | 114 | 126 | 149 |
| P | 25 | 70 | 28 | 29 | 42 | 42 | 41 | 46 | 60 | 79 | 84 | 84 | 92 | 101 | 119 |
| P | 30 | | 30 | 31 | 45 | 45 | 45 | 51 | 66 | 87 | 92 | 84 | 92 | 101 | 119 |
| P | 35 | | 33 | 35 | 48 | 48 | 48 | 56 | 71 | 93 | 99 | 90 | 99 | 109 | 129 |
| P | 40 | | 34 | 35 | 50 | 51 | 53 | 61 | 77 | 102 | 109 | 97 | 106 | 117 | 138 |
| P | 45 | | 36 | 37 | 52 | 54 | 56 | 65 | 82 | 109 | 115 | 103 | 113 | 124 | 147 |
| P | 50 | | 38 | 40 | 56 | 58 | 60 | 70 | 89 | 118 | 125 | 109 | 120 | 132 | 156 |
| P | 60 | | 42 | 43 | 60 | 63 | 67 | 79 | 99 | 131 | 139 | 122 | 134 | 148 | 175 |
| P | 25 | 80 | 30 | 32 | 46 | 45 | 45 | 51 | 66 | 87 | 92 | 92 | 102 | 112 | 132 |
| P | 30 | | 33 | 34 | 52 | 51 | 50 | 57 | 75 | 100 | 106 | 92 | 102 | 112 | 132 |
| P | 35 | | 36 | 37 | 52 | 53 | 53 | 62 | 78 | 104 | 110 | 100 | 111 | 122 | 144 |
| P | 40 | | 37 | 39 | 54 | 56 | 58 | 67 | 85 | 113 | 119 | 108 | 119 | 131 | 155 |
| P | 45 | | 39 | 41 | 57 | 59 | 62 | 72 | 91 | 121 | 128 | 116 | 128 | 141 | 166 |
| P | 50 | | 42 | 43 | 60 | 63 | 67 | 78 | 98 | 130 | 138 | 124 | 137 | 150 | 178 |
| P | 60 | | 45 | 47 | 64 | 69 | 74 | 88 | 109 | 145 | 153 | 140 | 154 | 169 | 200 |
| P | 25 | 90 | 33 | 34 | 49 | 49 | 49 | 56 | 72 | 95 | 100 | 101 | 112 | 123 | 145 |
| P | 30 | | 36 | 37 | 58 | 56 | 54 | 62 | 85 | 113 | 119 | 101 | 112 | 123 | 145 |
| P | 35 | | 38 | 39 | 55 | 57 | 58 | 68 | 86 | 114 | 120 | 111 | 122 | 134 | 159 |
| P | 40 | | 40 | 42 | 59 | 61 | 64 | 74 | 93 | 123 | 130 | 120 | 132 | 146 | 172 |
| P | 45 | | 42 | 44 | 62 | 65 | 68 | 80 | 100 | 133 | 140 | 130 | 143 | 157 | 185 |
| P | 50 | | 45 | 47 | 65 | 69 | 73 | 86 | 107 | 142 | 150 | 139 | 153 | 168 | 199 |
| P | 60 | | 49 | 51 | 69 | 75 | 81 | 97 | 120 | 158 | 168 | 157 | 173 | 190 | 224 |
| P | 25 | 127 | 46 | 48 | 69 | 69 | 69 | 78 | 100 | 133 | 141 | 142 | 156 | 172 | 203 |
| P | 30 | | 50 | 52 | 82 | 79 | 76 | 87 | 119 | 158 | 167 | 142 | 156 | 172 | 203 |
| P | 35 | | 53 | 55 | 78 | 80 | 82 | 95 | 120 | 159 | 169 | 155 | 171 | 188 | 222 |
| P | 40 | | 57 | 59 | 82 | 85 | 89 | 104 | 130 | 172 | 183 | 168 | 185 | 204 | 241 |
| P | 45 | | 59 | 62 | 86 | 91 | 95 | 111 | 140 | 186 | 197 | 182 | 200 | 220 | 260 |
| P | 50 | | 63 | 66 | 91 | 96 | 102 | 120 | 150 | 199 | 211 | 195 | 214 | 236 | 279 |
| P | 60 | | 68 | 71 | 97 | 105 | 114 | 136 | 168 | 222 | 235 | 220 | 242 | 266 | 314 |
| P | 25 | 147 | 49 | 52 | 74 | 74 | 74 | 83 | 108 | 142 | 151 | 152 | 167 | 184 | 217 |
| P | 30 | | 54 | 56 | 87 | 84 | 81 | 93 | 128 | 169 | 179 | 152 | 167 | 184 | 217 |
| P | 35 | | 57 | 59 | 83 | 85 | 88 | 101 | 129 | 170 | 181 | 166 | 183 | 201 | 238 |
| P | 40 | | 61 | 63 | 88 | 92 | 95 | 111 | 140 | 185 | 196 | 180 | 198 | 218 | 258 |
| P | 45 | | 64 | 66 | 92 | 97 | 102 | 119 | 150 | 199 | 211 | 195 | 214 | 235 | 278 |
| P | 50 | | 68 | 71 | 97 | 103 | 109 | 129 | 161 | 213 | 226 | 209 | 230 | 253 | 298 |
| P | 60 | | 73 | 76 | 104 | 113 | 122 | 146 | 180 | 238 | 252 | 235 | 259 | 285 | 337 |

DISEÑO FRENTE CAJON

| REF. | ANCHO | ALTO | 100 | 200 | 201 | 202 | 300 | 400 | 500 | 502 | 503 | 601 | 602 | 612 | 630 |
|------|-------|------|-----|-----|-----|-----|-----|-----|-----|-----|-----|-----|-----|-----|-----|
| F | 25 | 17,5 | 11 | 12 | 13 | 16 | 20 | 22 | 28 | 27 | 31 | 37 | 41 | 45 | 53 |
| F | 30 | | 11 | 12 | 13 | 16 | 20 | 22 | 28 | 30 | 35 | 37 | 41 | 45 | 53 |
| F | 35 | | 11 | 12 | 13 | 16 | 20 | 22 | 28 | 33 | 38 | 38 | 42 | 46 | 55 |
| F | 40 | | 12 | 13 | 14 | 18 | 22 | 24 | 30 | 36 | 41 | 39 | 43 | 47 | 56 |
| F | 45 | | 12 | 13 | 14 | 18 | 22 | 24 | 30 | 40 | 46 | 39 | 43 | 47 | 56 |
| F | 50 | | 15 | 16 | 18 | 23 | 28 | 31 | 39 | 43 | 49 | 41 | 45 | 50 | 59 |
| F | 60 | | 15 | 16 | 18 | 23 | 28 | 31 | 39 | 46 | 53 | 41 | 45 | 50 | 59 |
| F | 70 | | 18 | 19 | 21 | 27 | 33 | 37 | 44 | 52 | 59 | 46 | 51 | 55 | 66 |
| F | 80 | | 22 | 23 | 25 | 32 | 38 | 42 | 49 | 58 | 66 | 51 | 57 | 62 | 73 |
| F | 90 | | 24 | 25 | 28 | 35 | 42 | 46 | 55 | 65 | 74 | 58 | 63 | 70 | 82 |
| F | 25 | 20 | 12 | 13 | 14 | 18 | 22 | 24 | 30 | 30 | 45 | 43 | 47 | 52 | 61 |
| F | 30 | | 12 | 13 | 14 | 18 | 22 | 24 | 30 | 33 | 51 | 43 | 47 | 52 | 61 |
| F | 35 | | 12 | 13 | 14 | 18 | 22 | 24 | 30 | 36 | 54 | 45 | 50 | 54 | 64 |
| F | 40 | | 13 | 14 | 16 | 20 | 24 | 26 | 33 | 40 | 58 | 45 | 50 | 54 | 64 |
| F | 45 | | 13 | 14 | 16 | 20 | 24 | 26 | 33 | 44 | 60 | 47 | 52 | 56 | 66 |
| F | 50 | | 17 | 17 | 20 | 25 | 31 | 34 | 43 | 47 | 62 | 49 | 54 | 58 | 68 |
| F | 60 | | 17 | 17 | 20 | 25 | 31 | 34 | 43 | 51 | 63 | 51 | 56 | 60 | 70 |
| F | 70 | | 19 | 19 | 23 | 28 | 34 | 37 | 48 | 57 | 71 | 57 | 63 | 67 | 78 |
| F | 80 | | 22 | 22 | 25 | 30 | 36 | 40 | 54 | 63 | 79 | 64 | 70 | 75 | 88 |
| F | 90 | | 24 | 24 | 27 | 32 | 38 | 43 | 60 | 71 | 89 | 72 | 79 | 84 | 98 |

PUERTAS Y FRENTEROS

DISEÑO
FRENTEROS CAJON

TARIFA

| REF. | ANCHO | ALTO | 100 | 200 | 201 | 202 | 300 | 400 | 500 | 502 | 503 | 601 | 602 | 612 | 630 |
|------|-------|------|-----|-----|-----|-----|-----|-----|-----|-----|-----|-----|-----|-----|-----|
| F 25 | 35 | | 21 | 22 | 25 | 32 | 38 | 42 | 53 | 52 | 60 | 71 | 78 | 87 | 103 |
| F 30 | | | 21 | 22 | 25 | 32 | 38 | 42 | 53 | 58 | 67 | 71 | 78 | 87 | 103 |
| F 35 | | | 21 | 22 | 25 | 32 | 38 | 42 | 53 | 64 | 73 | 73 | 80 | 89 | 105 |
| F 40 | | | 23 | 24 | 27 | 35 | 42 | 46 | 58 | 69 | 79 | 75 | 83 | 91 | 108 |
| F 45 | | | 23 | 24 | 27 | 35 | 42 | 46 | 58 | 77 | 89 | 75 | 83 | 91 | 108 |
| F 50 | | | 29 | 31 | 34 | 44 | 54 | 60 | 75 | 83 | 94 | 79 | 87 | 95 | 113 |
| F 60 | | | 29 | 31 | 34 | 44 | 54 | 60 | 75 | 89 | 102 | 79 | 87 | 95 | 113 |
| F 70 | | | 32 | 34 | 38 | 49 | 60 | 67 | 84 | 99 | 114 | 88 | 97 | 107 | 126 |
| F 80 | | | 36 | 38 | 43 | 55 | 67 | 75 | 94 | 111 | 128 | 99 | 109 | 120 | 141 |
| F 90 | | | 41 | 43 | 48 | 62 | 75 | 84 | 105 | 124 | 143 | 111 | 122 | 134 | 158 |
| F 25 | 40 | | 24 | 26 | 29 | 36 | 44 | 48 | 61 | 59 | 68 | 81 | 90 | 99 | 117 |
| F 30 | | | 24 | 26 | 29 | 36 | 44 | 48 | 61 | 66 | 77 | 81 | 90 | 99 | 117 |
| F 35 | | | 24 | 26 | 29 | 36 | 44 | 48 | 61 | 73 | 84 | 84 | 92 | 102 | 120 |
| F 40 | | | 26 | 28 | 31 | 39 | 48 | 53 | 66 | 79 | 90 | 86 | 94 | 104 | 123 |
| F 45 | | | 26 | 28 | 31 | 39 | 48 | 53 | 66 | 88 | 101 | 86 | 94 | 104 | 123 |
| F 50 | | | 33 | 35 | 39 | 50 | 61 | 68 | 86 | 95 | 108 | 90 | 99 | 109 | 129 |
| F 60 | | | 33 | 35 | 39 | 50 | 61 | 68 | 86 | 101 | 117 | 90 | 99 | 109 | 129 |
| F 70 | | | 37 | 39 | 44 | 56 | 69 | 76 | 96 | 113 | 131 | 101 | 111 | 122 | 144 |
| F 80 | | | 41 | 44 | 49 | 63 | 77 | 86 | 107 | 127 | 146 | 113 | 124 | 137 | 161 |
| F 90 | | | 46 | 49 | 55 | 71 | 86 | 96 | 120 | 142 | 164 | 127 | 139 | 153 | 181 |

| | | | | | | | | | | | | | | |
|--------------------|------------|----|----|----|----|----|----|----|-----|-----|-----|-----|-----|-----|
| PANEL FRIGO LISO | PFL | 68 | 70 | 70 | 69 | 68 | 72 | 74 | 74 | 78 | 76 | 84 | 92 | 109 |
| PANEL FRIGO FORMA | PFF | | | | | | | | 246 | 276 | 319 | 351 | 386 | 456 |
| PANEL LAVAV. LISO | PLL | 34 | 35 | 35 | 35 | 34 | 36 | 37 | 37 | 39 | 38 | 42 | 46 | 55 |
| PANEL LAVAV. FORMA | PLF | | | | | | | | 139 | 156 | 163 | 179 | 197 | 233 |

PUERTAS DE COSTADO ,REGLETAS Y ENTREPAÑOS

DISEÑO
PUERTAS DE COSTADO
LISAS

TARIFA

| | | | | | | | | | | | | | | | | |
|--------------------------|------|-------|------|-----|-----|-----|-----|-----|-----|-----|-----|-----|-----|-----|-----|-----|
| COSTADO VISTO FONDO - 35 | REF. | ANCHO | ALTO | 100 | 200 | 201 | 202 | 300 | 400 | 500 | 502 | 503 | 601 | 602 | 612 | 630 |
| | PCL | 35 | 11 | 11 | 12 | 13 | 14 | 14 | 15 | 31 | 35 | 40 | 25 | 28 | 28 | 33 |
| | PCL | 35 | 20 | 13 | 15 | 16 | 18 | 19 | 22 | 31 | 36 | 48 | 30 | 33 | 33 | 39 |
| | PCL | 35 | 35 | 14 | 16 | 17 | 19 | 21 | 24 | 31 | 37 | 51 | 42 | 46 | 46 | 55 |
| | PCL | 35 | 45 | 15 | 17 | 18 | 21 | 24 | 27 | 31 | 39 | 53 | 42 | 46 | 46 | 55 |
| | PCL | 35 | 70 | 19 | 21 | 23 | 27 | 31 | 36 | 40 | 49 | 58 | 50 | 55 | 55 | 65 |
| | PCL | 35 | 80 | 20 | 22 | 25 | 29 | 34 | 40 | 45 | 55 | 65 | 56 | 62 | 60 | 72 |
| | PCL | 35 | 90 | 21 | 24 | 27 | 32 | 37 | 43 | 49 | 61 | 71 | 62 | 68 | 68 | 81 |
| | PCL | 35 | 127 | 26 | 29 | 34 | 41 | 48 | 57 | 62 | 79 | 81 | 84 | 92 | 92 | 109 |
| | PCL | 35 | 216 | 36 | 41 | 48 | 60 | 72 | 88 | 97 | 140 | 162 | 126 | 139 | 139 | 164 |
| PCL | 35 | 236 | 38 | 43 | 52 | 65 | 78 | 92 | 130 | 150 | 173 | 141 | 155 | 155 | 183 | |

| | | | | | | | | | | | | | | | | |
|--------------------------|-----|----|-----|----|----|----|----|-----|-----|-----|-----|-----|-----|-----|-----|-----|
| COSTADO VISTO FONDO - 60 | PCL | 60 | 70 | 23 | 26 | 30 | 37 | 43 | 52 | 62 | 79 | 91 | 85 | 94 | 94 | 111 |
| | PCL | 60 | 80 | 25 | 28 | 33 | 40 | 48 | 58 | 80 | 95 | 111 | 90 | 99 | 99 | 117 |
| | PCL | 60 | 90 | 27 | 30 | 36 | 44 | 52 | 64 | 97 | 111 | 131 | 95 | 105 | 105 | 124 |
| | PCL | 60 | 122 | 35 | 40 | 47 | 59 | 70 | 86 | 106 | 140 | 162 | 179 | 197 | 197 | 233 |
| | PCL | 60 | 216 | 51 | 59 | 71 | 91 | 110 | 137 | 176 | 209 | 241 | 187 | 206 | 206 | 243 |
| | PCL | 60 | 236 | 56 | 65 | 77 | 99 | 120 | 149 | 203 | 226 | 268 | 194 | 213 | 213 | 252 |

| | | | | |
|--|----|----|-----|-----|
| TABLERO ALVEOLAR GRUESO 5 CM (NOVEDAD) | TA | 35 | 70 | 63 |
| | TA | 35 | 90 | 72 |
| | TA | 35 | 127 | 87 |
| | TA | 35 | 216 | 123 |
| | TA | 35 | 236 | 129 |
| | TA | 60 | 70 | 78 |
| | TA | 60 | 90 | 90 |
| | TA | 60 | 127 | 120 |
| | TA | 60 | 216 | 177 |
| | TA | 60 | 236 | 195 |



HALIFAX NATURAL



HALIFAX TABACO

| | | | | | | | | | | | | | | | | |
|----------|---|----|-----|----|----|----|----|----|----|----|----|-----|----|----|----|----|
| REGLETAS | R | 5 | 70 | 6 | 9 | 10 | 12 | 14 | 15 | 14 | 23 | 30 | 24 | 26 | 26 | 31 |
| | R | | 80 | 7 | 10 | 11 | 13 | 15 | 16 | 15 | 24 | 31 | 26 | 28 | 28 | 33 |
| | R | | 90 | 7 | 11 | 12 | 14 | 16 | 18 | 16 | 25 | 32 | 28 | 31 | 31 | 36 |
| | R | | 127 | 9 | 13 | 14 | 17 | 20 | 22 | 23 | 37 | 42 | 37 | 40 | 40 | 48 |
| | R | | 216 | 16 | 18 | 21 | 24 | 28 | 31 | 38 | 60 | 71 | 51 | 56 | 56 | 67 |
| | R | | 236 | 19 | 22 | 23 | 27 | 31 | 35 | 42 | 68 | 80 | 56 | 62 | 62 | 73 |
| | R | 10 | 70 | 8 | 11 | 13 | 15 | 17 | 19 | 17 | 29 | 38 | 30 | 33 | 33 | 39 |
| | R | | 80 | 9 | 13 | 14 | 17 | 19 | 21 | 19 | 30 | 39 | 34 | 37 | 38 | 44 |
| | R | | 90 | 9 | 14 | 15 | 18 | 20 | 22 | 20 | 31 | 40 | 35 | 39 | 39 | 46 |
| | R | | 127 | 11 | 16 | 18 | 22 | 25 | 27 | 29 | 46 | 53 | 46 | 51 | 51 | 60 |
| | R | | 216 | 20 | 22 | 26 | 31 | 35 | 39 | 47 | 75 | 89 | 64 | 70 | 70 | 83 |
| | R | | 236 | 24 | 27 | 29 | 34 | 39 | 44 | 52 | 85 | 100 | 70 | 77 | 77 | 91 |

| | | | | | | | | | | | | | | | |
|-----------------------------|---------------|----|----|-------------|----|----|---------|----|----|---------------|----|----|-----------------|----|----|
| ENTREPAÑOS ALTOS INTERIORES | BLANCOS 16 MM | | | COLOR 16 MM | | | CRISTAL | | | BLANCOS 19 MM | | | ANTRACITA 19 MM | | |
| | EAB | 30 | 5 | EAC | 30 | 6 | EACR | 30 | 6 | EAB | 30 | 6 | EAC | 30 | 7 |
| | | 35 | 6 | | 35 | 7 | | 35 | 7 | | 35 | 7 | | 35 | 8 |
| | | 40 | 7 | | 40 | 8 | | 40 | 8 | | 40 | 8 | | 40 | 9 |
| | | 45 | 9 | | 45 | 10 | | 45 | 10 | | 45 | 10 | | 45 | 11 |
| | | 50 | 10 | | 50 | 11 | | 50 | 11 | | 50 | 11 | | 50 | 12 |
| | | 60 | 12 | | 60 | 13 | | 60 | 13 | | 60 | 13 | | 60 | 14 |
| | | 70 | 14 | | 70 | 15 | | 70 | 15 | | 70 | 15 | | 70 | 16 |
| | | 80 | 16 | | 80 | 17 | | 80 | 17 | | 80 | 18 | | 80 | 19 |
| | | 90 | 18 | | 90 | 19 | | 90 | 19 | | 90 | 20 | | 90 | 21 |
| | 100 | 20 | | 100 | 21 | | 100 | 21 | | 100 | 22 | | 100 | 23 | |

| | | | | | | | | | | | | | | | |
|-----------------------------|-----|-----|----|-----|-----|----|------|-----|----|-----|-----|----|-----|-----|----|
| ENTREPAÑOS BAJOS INTERIORES | EBB | 30 | 6 | EBC | 30 | 7 | EBCR | 30 | 7 | EBB | 30 | 7 | EBC | 30 | 8 |
| | | 35 | 8 | | 35 | 9 | | 35 | 9 | | 35 | 9 | | 35 | 10 |
| | | 40 | 9 | | 40 | 10 | | 40 | 10 | | 40 | 10 | | 40 | 11 |
| | | 45 | 10 | | 45 | 11 | | 45 | 11 | | 45 | 11 | | 45 | 12 |
| | | 50 | 12 | | 50 | 13 | | 50 | 13 | | 50 | 13 | | 50 | 14 |
| | | 60 | 14 | | 60 | 15 | | 60 | 15 | | 60 | 15 | | 60 | 16 |
| | | 70 | 16 | | 70 | 17 | | 70 | 17 | | 70 | 17 | | 70 | 18 |
| | | 80 | 19 | | 80 | 20 | | 80 | 20 | | 80 | 21 | | 80 | 22 |
| | | 90 | 22 | | 90 | 24 | | 90 | 24 | | 90 | 24 | | 90 | 26 |
| | | 100 | 25 | | 100 | 27 | | 100 | 27 | | 100 | 27 | | 100 | 29 |

| REFER. | DESCRIPCION | ACABADO | MEDIDA | PAGINA | PUNTOS | REFER. | DESCRIPCION | ACABADO | MEDIDA | PAGINA | PUNTOS |
|--------|-------------|----------------|--------|--------|--------|--------|-------------|--------------|--------|--------|--------|
| 2020 | ASA | NIQUEL-MATE | 128 | T-1 | 6 | 3634 | ASA | CROMO MATE | 64 | T-3 | 8 |
| 2021 | ASA | CROMO | 128 | T-1 | 5 | 3635 | ASA | CROMO MATE | 128 | T-3 | 8 |
| 3003 | ASA BARRA | INOX | 160 | T-1 | 6 | 3636 | ASA | CROMO MATE | 128 | T-4 | 9 |
| 3522 | ASA | NIQUEL-MATE | 160 | T-1 | 11 | 3637 | ASA | CROMO MATE | 160 | T-4 | 9 |
| 3530 | ASA BARRA | INOX | 96 | T-1 | 14 | 3638 | ASA | CROMO MATE | 160 | T-4 | 8 |
| 3531 | ASA BARRA | INOX | 128 | T-1 | 15 | 3639 | ASA | CROMO MATE | 128 | T-4 | 8 |
| 3532 | ASA BARRA | INOX | 160 | T-1 | 15 | 3640 | TIRADOR | ALUMINIO | 64-128 | T-1 | 6 |
| 3533 | ASA BARRA | INOX | 192 | T-1 | 16 | 3641 | TIRADOR | NEGRO | 64-128 | T-1 | 6 |
| 3534 | ASA BARRA | INOX | 242 | T-1 | 18 | 3642 | TIRADOR | ANTRACITA | 64-128 | T-1 | 6 |
| 3535 | ASA BARRA | INOX | 292 | T-1 | 19 | 3643 | ASA | COBRE | 160 | T-1 | 8 |
| 3536 | ASA BARRA | INOX | 342 | T-1 | 21 | 3644 | ASA | NIQ.SATINADO | 160 | T-1 | 8 |
| 3537 | ASA BARRA | INOX | 392 | T-1 | 22 | 3645 | ASA | ANTRACITA | 160 | T-1 | 8 |
| 3538 | ASA BARRA | INOX | 492 | T-1 | 25 | 3646 | TIRADOR | NEGRO MAT | 192 | T-5 | 6 |
| 3539 | ASA BARRA | INOX | 592 | T-1 | 27 | 3647 | TIRADOR | NIQUEL NEG | 160 | T-5 | 8 |
| 3540 | ASA BARRA | INOX | 692 | T-1 | 31 | 3648 | TIRADOR | COBRE NEGR | 160 | T-5 | 8 |
| 3541 | ASA BARRA | INOX | 792 | T-1 | 35 | 3649 | TIRADOR | PLATA AREN | 160 | T-5 | 7 |
| 3542 | ASA BARRA | INOX | 992 | T-1 | 44 | 3650 | TIRADOR | OXIDO AREN | 160 | T-5 | 7 |
| 3555 | ASA | ANODIZADO M. | 128 | T-1 | 6 | 3651 | TIRADOR | CR MATE | 160 | T-5 | 6 |
| 3558 | ASA | ANODIZADO M. | 160 | T-1 | 9 | 3652 | TIRADOR | NEGRO | 160 | T-5 | 5 |
| 3568 | ASA | CR. SATINADO | 240 | T-1 | 7 | 3653 | TIRADOR | BLANCO | 160 | T-5 | 5 |
| 3570 | ASA | CROMO MATE | 160 | T-1 | 6 | 3654 | TIRADOR | LATON VIEJO | 160 | T-5 | 9 |
| 3584 | ASA | NIQUEL SAT. | 160 | T-2 | 16 | 3655 | TIRADOR | PLATA VIEJA | 96 | T-5 | 6 |
| 3585 | ASA | NIQUEL SAT. | 320 | T-2 | 22 | 3656 | TIRADOR | OXIDO AREN | 32 | T-5 | 9 |
| 3587 | ASA | CROMO MATE | 160 | T-2 | 5 | 3657 | TIRADOR | PLATA AREN | 32 | T-5 | 9 |
| 3590 | ASA | NIQUEL SAT. | 192 | T-2 | 7 | 3658 | TIRADOR | CR MATE | 32 | T-6 | 8 |
| 3601 | ASA | NIQUEL SAT. | 160 | T-2 | 11 | 3659 | TIRADOR | PLATA VIEJA | 64 | T-6 | 6 |
| 3604 | ASA | CROMO MATE | 160 | T-2 | 3 | 3660 | TIRADOR | COBRE ANTI | 64 | T-6 | 5 |
| 3605 | ASA | CROMO MATE | 128 | T-2 | 5 | | | | | | |
| 3606 | ASA | CROMO MATE | 160 | T-2 | 5 | | | | | | |
| 3607 | ASA | NIQUEL SAT. | 128 | T-2 | 4 | | | | | | |
| 3608 | ASA | NIQUEL SAT. | 224 | T-2 | 6 | | | | | | |
| 3609 | ASA | NIQUEL SAT. | 192 | T-2 | 18 | | | | | | |
| 3610 | ASA | NIQUEL SAT. | 320 | T-2 | 25 | TU15 | TIR.UÑERO | ALUMINIO | 150 | T-4 | 11 |
| 3616 | TIRADOR | EMBUTIDO | 128 | T-2 | 6 | TU20 | TIR.UÑERO | ALUMINIO | 200 | T-4 | 11 |
| 3620 | TIRADOR | CROMO MATE | 160 | T-2 | 4 | TU25 | TIR.UÑERO | ALUMINIO | 250 | T-4 | 12 |
| 3621 | ASA | NIQUEL SAT. | 320 | T-3 | 11 | TU30 | TIR.UÑERO | ALUMINIO | 300 | T-4 | 12 |
| 3622 | ASA | NIQUEL SAT. | 166 | T-3 | 7 | TU35 | TIR.UÑERO | ALUMINIO | 350 | T-4 | 14 |
| 3623 | TIRADOR | INOX LOOK | 160 | T-3 | 13 | TU40 | TIR.UÑERO | ALUMINIO | 400 | T-4 | 14 |
| 3624 | TIRADOR | INOX LOOK | 32 | T-3 | 9 | TU45 | TIR.UÑERO | ALUMINIO | 450 | T-4 | 15 |
| 3625 | TIRADOR | BLANCO | 192 | T-3 | 10 | TU50 | TIR.UÑERO | ALUMINIO | 500 | T-4 | 16 |
| 3626 | TIRADOR | BLANCO | 32 | T-3 | 5 | TU60 | TIR.UÑERO | ALUMINIO | 600 | T-4 | 18 |
| 3627 | TIRADOR | NIQUEL CEPILL. | 192 | T-3 | 12 | TU70 | TIR.UÑERO | ALUMINIO | 700 | T-4 | 22 |
| 3628 | TIRADOR | NIQUEL CEPILL. | 32 | T-3 | 6 | TU80 | TIR.UÑERO | ALUMINIO | 800 | T-4 | 24 |
| 3629 | ASA | NIQUEL SAT. | 288 | T-3 | 9 | TU90 | TIR.UÑERO | ALUMINIO | 900 | T-4 | 26 |
| 3630 | ASA | NIQUEL SAT. | 160 | T-3 | 5 | TU100 | TIR.UÑERO | ALUMINIO | 1000 | T-4 | 27 |

| | | | | | | | | | | | |
|----------|---------------|-----------|------|-----|----|---------|----------------|----------|------|-----|----|
| 3631/15 | TIRADOR FORMA | INOX LOOK | 150 | T-3 | 8 | TEGN15 | T. EFECTO GOLA | ALUMINIO | 150 | T-4 | 9 |
| 3631/20 | TIRADOR FORMA | INOX LOOK | 200 | T-3 | 10 | TEGN20 | T. EFECTO GOLA | ALUMINIO | 200 | T-4 | 10 |
| 3631/25 | TIRADOR FORMA | INOX LOOK | 250 | T-3 | 12 | TEGN25 | T. EFECTO GOLA | ALUMINIO | 250 | T-4 | 10 |
| 3631/30 | TIRADOR FORMA | INOX LOOK | 300 | T-3 | 14 | TEGN30 | T. EFECTO GOLA | ALUMINIO | 300 | T-4 | 11 |
| 3631/35 | TIRADOR FORMA | INOX LOOK | 350 | T-3 | 15 | TEGN35 | T. EFECTO GOLA | ALUMINIO | 350 | T-4 | 12 |
| 3631/40 | TIRADOR FORMA | INOX LOOK | 400 | T-3 | 17 | TEGN40 | T. EFECTO GOLA | ALUMINIO | 400 | T-4 | 13 |
| 3631/45 | TIRADOR FORMA | INOX LOOK | 450 | T-3 | 19 | TEGN45 | T. EFECTO GOLA | ALUMINIO | 450 | T-4 | 15 |
| 3631/50 | TIRADOR FORMA | INOX LOOK | 500 | T-3 | 21 | TEGN50 | T. EFECTO GOLA | ALUMINIO | 500 | T-4 | 16 |
| 3631/60 | TIRADOR FORMA | INOX LOOK | 600 | T-3 | 25 | TEGN60 | T. EFECTO GOLA | ALUMINIO | 600 | T-4 | 18 |
| 3631/70 | TIRADOR FORMA | INOX LOOK | 700 | T-3 | 29 | TEGN70 | T. EFECTO GOLA | ALUMINIO | 700 | T-4 | 21 |
| 3631/80 | TIRADOR FORMA | INOX LOOK | 800 | T-3 | 33 | TEGN80 | T. EFECTO GOLA | ALUMINIO | 800 | T-4 | 23 |
| 3631/90 | TIRADOR FORMA | INOX LOOK | 900 | T-3 | 37 | TEGN90 | T. EFECTO GOLA | ALUMINIO | 900 | T-4 | 26 |
| 3631/100 | TIRADOR FORMA | INOX LOOK | 1000 | T-3 | 41 | TEGN100 | T. EFECTO GOLA | ALUMINIO | 1000 | T-4 | 29 |
| 3631/120 | TIRADOR FORMA | INOX LOOK | 1200 | T-3 | 51 | TEGN120 | T. EFECTO GOLA | ALUMINIO | 1200 | T-4 | 32 |

| REFER. | DESCRIPCION | ACABADO | MEDIDA | PAGINA | PUNTOS |
|---------|----------------|---------|--------|--------|--------|
| TEGN15 | T. EFECTO GOLA | NEGRO | 150 | T-4 | 12 |
| TEGN20 | T. EFECTO GOLA | NEGRO | 200 | T-4 | 13 |
| TEGN25 | T. EFECTO GOLA | NEGRO | 250 | T-4 | 13 |
| TEGN30 | T. EFECTO GOLA | NEGRO | 300 | T-4 | 14 |
| TEGN35 | T. EFECTO GOLA | NEGRO | 350 | T-4 | 16 |
| TEGN40 | T. EFECTO GOLA | NEGRO | 400 | T-4 | 17 |
| TEGN45 | T. EFECTO GOLA | NEGRO | 450 | T-4 | 20 |
| TEGN50 | T. EFECTO GOLA | NEGRO | 500 | T-4 | 21 |
| TEGN60 | T. EFECTO GOLA | NEGRO | 600 | T-4 | 23 |
| TEGN70 | T. EFECTO GOLA | NEGRO | 700 | T-4 | 27 |
| TEGN80 | T. EFECTO GOLA | NEGRO | 800 | T-4 | 30 |
| TEGN90 | T. EFECTO GOLA | NEGRO | 900 | T-4 | 34 |
| TEGN100 | T. EFECTO GOLA | NEGRO | 1000 | T-4 | 38 |
| TEGN120 | T. EFECTO GOLA | NEGRO | 1200 | T-4 | 42 |

| | | | | | |
|---------|----------------|--------|------|-----|----|
| TEGB15 | T. EFECTO GOLA | BLANCO | 150 | T-4 | 12 |
| TEGB20 | T. EFECTO GOLA | BLANCO | 200 | T-4 | 13 |
| TEGB25 | T. EFECTO GOLA | BLANCO | 250 | T-4 | 13 |
| TEGB30 | T. EFECTO GOLA | BLANCO | 300 | T-4 | 14 |
| TEGB35 | T. EFECTO GOLA | BLANCO | 350 | T-4 | 16 |
| TEGB40 | T. EFECTO GOLA | BLANCO | 400 | T-4 | 17 |
| TEGB45 | T. EFECTO GOLA | BLANCO | 450 | T-4 | 20 |
| TEGB50 | T. EFECTO GOLA | BLANCO | 500 | T-4 | 21 |
| TEGB60 | T. EFECTO GOLA | BLANCO | 600 | T-4 | 23 |
| TEGB70 | T. EFECTO GOLA | BLANCO | 700 | T-4 | 27 |
| TEGB80 | T. EFECTO GOLA | BLANCO | 800 | T-4 | 30 |
| TEGB90 | T. EFECTO GOLA | BLANCO | 900 | T-4 | 34 |
| TEGB100 | T. EFECTO GOLA | BLANCO | 1000 | T-4 | 38 |
| TEGB120 | T. EFECTO GOLA | BLANCO | 1200 | T-4 | 42 |

| | | | | | |
|---------|----------------|-----------|------|-----|----|
| TEGA15 | T. EFECTO GOLA | ANTRACITA | 150 | T-5 | 12 |
| TEGA20 | T. EFECTO GOLA | ANTRACITA | 200 | T-5 | 13 |
| TEGA25 | T. EFECTO GOLA | ANTRACITA | 250 | T-5 | 13 |
| TEGA30 | T. EFECTO GOLA | ANTRACITA | 300 | T-5 | 14 |
| TEGA35 | T. EFECTO GOLA | ANTRACITA | 350 | T-5 | 16 |
| TEGA40 | T. EFECTO GOLA | ANTRACITA | 400 | T-5 | 17 |
| TEGA45 | T. EFECTO GOLA | ANTRACITA | 450 | T-5 | 20 |
| TEGA50 | T. EFECTO GOLA | ANTRACITA | 500 | T-5 | 21 |
| TEGA60 | T. EFECTO GOLA | ANTRACITA | 600 | T-5 | 23 |
| TEGA70 | T. EFECTO GOLA | ANTRACITA | 700 | T-5 | 27 |
| TEGA80 | T. EFECTO GOLA | ANTRACITA | 800 | T-5 | 30 |
| TEGA90 | T. EFECTO GOLA | ANTRACITA | 900 | T-5 | 34 |
| TEGA100 | T. EFECTO GOLA | ANTRACITA | 1000 | T-5 | 38 |
| TEGA120 | T. EFECTO GOLA | ANTRACITA | 1200 | T-5 | 42 |

| REFER. | DESCRIPCION | ACABADO | MED. | PAG. | PTOS. |
|----------|----------------|-----------|------|------|-------|
| 3663/15 | TIRADOR LINEAL | INOX LOOK | 150 | T-3 | 8 |
| 3663/20 | TIRADOR LINEAL | INOX LOOK | 200 | T-3 | 10 |
| 3663/25 | TIRADOR LINEAL | INOX LOOK | 250 | T-3 | 12 |
| 3663/30 | TIRADOR LINEAL | INOX LOOK | 300 | T-3 | 14 |
| 3663/35 | TIRADOR LINEAL | INOX LOOK | 350 | T-3 | 15 |
| 3663/40 | TIRADOR LINEAL | INOX LOOK | 400 | T-3 | 17 |
| 3663/45 | TIRADOR LINEAL | INOX LOOK | 450 | T-3 | 19 |
| 3663/50 | TIRADOR LINEAL | INOX LOOK | 500 | T-3 | 21 |
| 3663/60 | TIRADOR LINEAL | INOX LOOK | 600 | T-3 | 25 |
| 3663/70 | TIRADOR LINEAL | INOX LOOK | 700 | T-3 | 29 |
| 3663/80 | TIRADOR LINEAL | INOX LOOK | 800 | T-3 | 33 |
| 3663/90 | TIRADOR LINEAL | INOX LOOK | 900 | T-3 | 37 |
| 3663/100 | TIRADOR LINEAL | INOX LOOK | 1000 | T-3 | 41 |
| 3663/120 | TIRADOR LINEAL | INOX LOOK | 1200 | T-3 | 51 |

| | | | | | |
|----------|----------------|-------|------|-----|----|
| 3662/15 | TIRADOR VECTOR | NEGRO | 150 | T-3 | 8 |
| 3662/20 | TIRADOR VECTOR | NEGRO | 200 | T-3 | 10 |
| 3662/25 | TIRADOR VECTOR | NEGRO | 250 | T-3 | 12 |
| 3662/30 | TIRADOR VECTOR | NEGRO | 300 | T-3 | 14 |
| 3662/35 | TIRADOR VECTOR | NEGRO | 350 | T-3 | 15 |
| 3662/40 | TIRADOR VECTOR | NEGRO | 400 | T-3 | 17 |
| 3662/45 | TIRADOR VECTOR | NEGRO | 450 | T-3 | 19 |
| 3662/50 | TIRADOR VECTOR | NEGRO | 500 | T-3 | 21 |
| 3662/60 | TIRADOR VECTOR | NEGRO | 600 | T-3 | 25 |
| 3662/70 | TIRADOR VECTOR | NEGRO | 700 | T-3 | 29 |
| 3662/80 | TIRADOR VECTOR | NEGRO | 800 | T-3 | 33 |
| 3662/90 | TIRADOR VECTOR | NEGRO | 900 | T-3 | 37 |
| 3662/100 | TIRADOR VECTOR | NEGRO | 1000 | T-3 | 41 |
| 3662/120 | TIRADOR VECTOR | NEGRO | 1200 | T-3 | 51 |

| | | | | | |
|----------|---------------|-----------|------|-----|----|
| 3661/15 | TIRADOR GRADA | INOX LOOK | 150 | T-3 | 8 |
| 3661/20 | TIRADOR GRADA | INOX LOOK | 200 | T-3 | 10 |
| 3661/25 | TIRADOR GRADA | INOX LOOK | 250 | T-3 | 12 |
| 3661/30 | TIRADOR GRADA | INOX LOOK | 300 | T-3 | 14 |
| 3661/35 | TIRADOR GRADA | INOX LOOK | 350 | T-3 | 15 |
| 3661/40 | TIRADOR GRADA | INOX LOOK | 400 | T-3 | 17 |
| 3661/45 | TIRADOR GRADA | INOX LOOK | 450 | T-3 | 19 |
| 3661/50 | TIRADOR GRADA | INOX LOOK | 500 | T-3 | 21 |
| 3661/60 | TIRADOR GRADA | INOX LOOK | 600 | T-3 | 25 |
| 3661/70 | TIRADOR GRADA | INOX LOOK | 700 | T-3 | 29 |
| 3661/80 | TIRADOR GRADA | INOX LOOK | 800 | T-3 | 33 |
| 3661/90 | TIRADOR GRADA | INOX LOOK | 900 | T-3 | 37 |
| 3661/100 | TIRADOR GRADA | INOX LOOK | 1000 | T-3 | 41 |
| 3661/120 | TIRADOR GRADA | INOX LOOK | 1200 | T-3 | 51 |

| | | | |
|---|---|--|---|
|  | <p>CODIGO / REF. 2020-2021 MED. TALADRO 128 mm MED. TOTAL 165 mm COLOR NIQUEL MATE</p> |  | <p>CODIGO / REF. 3003 MED. TALADRO 160 mm MED. TOTAL 215 mm COLOR ACERO INOX</p> |
|---|---|--|---|

| | | | |
|---|--|--|--|
|  | <p>CODIGO / REF. 3522 MED. TALADRO 160 mm MED. TOTAL 170 mm COLOR NIQUEL MATE</p> |  | <p>CODIGO / REF. 3643 MED. TALADRO 192 mm MED. TOTAL 205 mm COLOR COBRE</p> |
|---|--|--|--|

| | | | |
|--|--|--|--|
|  | <p>CODIGO / REF. 3644 MED. TALADRO 192 mm MED. TOTAL 205 mm COLOR NIQUEL SAT.</p> |  | <p>CODIGO / REF. 3645 MED. TALADRO 192 mm MED. TOTAL 205 mm COLOR ANTRACITA</p> |
|--|--|--|--|

| | | | | | | | |
|--|------------|--------|--------|--------|--------|---------|--------|
|  | | | | | | | |
| HORIZONTAL PARA PUERTA DE | 25 | 30 | 35 | 40 | 45 | 50 | 60 |
| CODIGO / REF. | 3530 | 3531 | 3532 | 3533 | 3534 | 3535 | 3536 |
| MED. TALADRO | 96 mm | 128 mm | 160 mm | 192 mm | 242 mm | 292 mm | 342 mm |
| MED. TOTAL | 155 mm | 192 mm | 222 mm | 256 mm | 306 mm | 356 mm | 406 mm |
| CODIGO / REF. | 3537 | 3538 | 3539 | 3540 | 3541 | 3542 | |
| MED. TALADRO | 392 mm | 492 mm | 592 mm | 692 mm | 792 mm | 992 mm | |
| MED. TOTAL | 456 mm | 556 mm | 656 mm | 756 mm | 856 mm | 1056 mm | |
| COLOR | ACERO INOX | | | | | | |

| | | | |
|---|---|--|---|
|  | <p>CODIGO / REF. 3555 MED. TALADRO 128 mm MED. TOTAL 134 mm COLOR ANODIZA.MATE</p> |  | <p>CODIGO / REF. 3558 MED. TALADRO 160 mm MED. TOTAL 170 mm COLOR ANODIZA.MATE</p> |
|---|---|--|---|

| | | | |
|---|---|--|---|
|  | <p>CODIGO / REF. 3568 MED. TALADRO 240 mm MED. TOTAL 271 mm COLOR CR. SATINADO</p> |  | <p>CODIGO / REF. 3570 MED. TALADRO 160 mm MED. TOTAL 200 mm COLOR CROMO MATE</p> |
|---|---|--|---|

| | | | |
|--|--|---|---|
|  | <p>CODIGO / REF. 3640 MED. TALADRO 64-128 mm MED. TOTAL 150 mm COLOR ALUMINIO</p> | <p>CODIGO / REF. 3641 MED. TALADRO 64-128 mm MED. TOTAL 150 mm COLOR NEGRO</p> | <p>CODIGO / REF. 3642 MED. TALADRO 64-128 mm MED. TOTAL 150 mm COLOR ANTRACITA</p> |
|--|--|---|---|

| | | | |
|--|---|--|---|
|  | <p>CODIGO / REF. 3584 MED. TALADRO 160 mm MED. TOTAL 170 mm COLOR NIQ. SATINADO</p> |  | <p>CODIGO / REF. 3585 MED. TALADRO 320 mm MED. TOTAL 330 mm COLOR NIQ. SATINADO</p> |
|--|---|--|---|

| | | | |
|--|--|--|---|
|  | <p>CODIGO / REF. 3587 MED. TALADRO 160 mm MED. TOTAL 166 mm COLOR CROMO MATE</p> |  | <p>CODIGO / REF. 3590 MED. TALADRO 192 mm MED. TOTAL 205 mm COLOR NIQ. SATINADO</p> |
|--|--|--|---|

| | | | |
|--|---|--|--|
|  | <p>CODIGO / REF. 3601 MED. TALADRO 160 mm MED. TOTAL 172 mm COLOR NIQ. SATINADO</p> |  | <p>CODIGO / REF. 3604 MED. TALADRO 160 mm MED. TOTAL 173 mm COLOR CROMO MATE</p> |
|--|---|--|--|

| | | | |
|--|--|--|--|
|  | <p>CODIGO / REF. 3605 MED. TALADRO 128 mm MED. TOTAL 196 mm COLOR CROMO MATE</p> |  | <p>CODIGO / REF. 3606 MED. TALADRO 160 mm MED. TOTAL 176 mm COLOR CROMO MATE</p> |
|--|--|--|--|





| | | |
|---|--|--|
|  | <p>REFERENCIA 3607 MED. TALADRO 128 mm MED. TOTAL 139 mm COLOR NIQ. SATINADO</p> | <p>REFERENCIA 3608 MED. TALADRO 224 mm MED. TOTAL 236 mm COLOR NIQ. SATINADO</p> |
|---|--|--|

| | | |
|---|--|--|
|  | <p>REFERENCIA 3609 MED. TALADRO 192 mm MED. TOTAL 220 mm COLOR NIQ. SATINADO</p> | <p>REFERENCIA 3610 MED. TALADRO 320 mm MED. TOTAL 348 mm COLOR NIQ. SATINADO</p> |
|---|--|--|

| | | | |
|--|--|--|--|
|  | <p>CODIGO / REF. 3616 MED. TALADRO 120 MED. TOTAL 150 COLOR CROMO MATE</p> |  | <p>CODIGO / REF. 3620 MED. TALADRO 160 MED. TOTAL COLOR ACERO INOX</p> |
|--|--|--|--|

| | | |
|---|---------------------|---------------|
|  | CODIGO / REF. | CODIGO / REF. |
| | 3621 | 3622 |
| | MED. TALADRO | MED. TALADRO |
| | 320 mm | 166 mm |
| | MED. TOTAL | MED. TOTAL |
| | 358 mm | 194 mm |
| COLOR | COLOR | |
| NIQUEL SATIN | NIQUEL SATIN | |

| | | |
|--|------------------|---------------|
|  | CODIGO / REF. | CODIGO / REF. |
| | 3623 | 3624 |
| | MED. TALADRO | MED. TALADRO |
| | 160 mm | 32 mm |
| | MED. TOTAL | MED. TOTAL |
| | 290 mm | 140 mm |
| COLOR | COLOR | |
| INOX LOOK | INOX LOOK | |

| | | | |
|--|---|---------------|---------------|
|  |  | CODIGO / REF. | CODIGO / REF. |
| | | 3625 | 3626 |
| | | MED. TALADRO | MED. TALADRO |
| | | 192 mm | 32 mm |
| | | MED. TOTAL | MED. TOTAL |
| | | 312 mm | 88 mm |
| COLOR | COLOR | | |
| BLANCO | BLANCO | | |
|  |  | CODIGO / REF. | CODIGO / REF. |
| | | 3627 | 3628 |
| | | MED. TALADRO | MED. TALADRO |
| | | 192 mm | 32 mm |
| | | MED. TOTAL | MED. TOTAL |
| | | 312 mm | 88 mm |
| COLOR | COLOR | | |
| NIQUEL CEPILL | NIQUEL CEPILL | | |

| | | |
|--|---------------------|---------------|
|  | CODIGO / REF. | CODIGO / REF. |
| | 3629 | 3630 |
| | MED. TALADRO | MED. TALADRO |
| | 288 mm | 160 mm |
| | MED. TOTAL | MED. TOTAL |
| | 309 mm | 182 mm |
| COLOR | COLOR | |
| NIQUEL SATIN | NIQUEL SATIN | |

| | | | |
|---|---------------|--|---------------|
|  | CODIGO / REF. |  | CODIGO / REF. |
| | 3634 | | 3635 |
| | MED. TALADRO | | MED. TALADRO |
| | 64 mm | | 128 mm |
| | MED. TOTAL | | MED. TOTAL |
| | 79 mm | | 133 mm |
| COLOR | COLOR | | |
| INOX | INOX | | |

| | | | |
|--|---------------|--|---------------|
|  | CODIGO/REF. |  | CODIGO / REF. |
| | 3636 | | 3637 |
| | MED. TALADRO | | MED. TALADRO |
| | 128 mm | | 160 mm |
| | MED. TOTAL | | MED. TOTAL |
| | 191 mm | | 185 mm |
| COLOR | COLOR | | |
| ALUM. MATE | INOX | | |



TIRADOR UÑERO ALUMINIO MATE

| | | | | | | | |
|----------------------|-------------|-------------|-------------|-------------|-------------|--------------|-------------|
| CODIGO / REF. | TU15 | TU20 | TU25 | TU30 | TU35 | TU40 | TU45 |
| MEDIDA | 150 mm | 200 mm | 250 mm | 300 mm | 350 mm | 400 mm | 450 mm |
| CODIGO / REF. | TU50 | TU60 | TU70 | TU80 | TU90 | TU100 | |
| MEDIDA | 500 mm | 600 mm | 700 mm | 800 mm | 900 mm | 1000 mm | |

TIRADOR EFECTO GOLA ALUMINIO

| | | | | |
|-------------------|---------------|---------------|--------------|--------------|
| REFERENCIA | TEG15 | TEG20 | TEG25 | TEG30 |
| MEDIDA | 150 mm | 200 mm | 250 mm | 300 mm |
| REFERENCIA | TEG35 | TEG40 | TEG45 | TEG50 |
| MEDIDA | 350 mm | 400 mm | 450 mm | 500 mm |
| REFERENCIA | TEG60 | TEG70 | TEG80 | TEG90 |
| MEDIDA | 600 mm | 700 mm | 800 mm | 900 mm |
| REFERENCIA | TEG100 | TEG120 | | |
| MEDIDA | 1000 mm | 1200 mm | | |

TIRADOR EFECTO GOLA BLANCO

| | | | | |
|-------------------|----------------|----------------|---------------|---------------|
| REFERENCIA | TEGB15 | TEGB20 | TEGB25 | TEGB30 |
| MEDIDA | 150 mm | 200 mm | 250 mm | 300 mm |
| REFERENCIA | TEGB35 | TEGB40 | TEGB45 | TEGB50 |
| MEDIDA | 350 mm | 400 mm | 450 mm | 500 mm |
| REFERENCIA | TEGB60 | TEGB70 | TEGB80 | TEGB90 |
| MEDIDA | 600 mm | 700 mm | 800 mm | 900 mm |
| REFERENCIA | TEGB100 | TEGB120 | | |
| MEDIDA | 1000 mm | 1200 mm | | |

TIRADOR EFECTO GOLA NEGRO

| | | | | |
|-------------------|----------------|----------------|---------------|---------------|
| REFERENCIA | TEGN15 | TEGN20 | TEGN25 | TEGN30 |
| MEDIDA | 150 mm | 200 mm | 250 mm | 300 mm |
| REFERENCIA | TEGN35 | TEGN40 | TEGN45 | TEGN50 |
| MEDIDA | 350 mm | 400 mm | 450 mm | 500 mm |
| REFERENCIA | TEGN60 | TEGN70 | TEGN80 | TEGN90 |
| MEDIDA | 600 mm | 700 mm | 800 mm | 900 mm |
| REFERENCIA | TEGN100 | TEGN120 | | |
| MEDIDA | 1000 mm | 1200 mm | | |

TIRADOR EFECTO GOLA ANTRACITA

| | | | | |
|-------------------|----------------|----------------|---------------|---------------|
| REFERENCIA | TEGA15 | TEGA20 | TEGA25 | TEGA30 |
| MEDIDA | 150 mm | 200 mm | 250 mm | 300 mm |
| REFERENCIA | TEGA35 | TEGA40 | TEGA45 | TEGA50 |
| MEDIDA | 350 mm | 400 mm | 450 mm | 500 mm |
| REFERENCIA | TEGA60 | TEGA70 | TEGA80 | TEGA90 |
| MEDIDA | 600 mm | 700 mm | 800 mm | 900 mm |
| REFERENCIA | TEGA100 | TEGA120 | | |
| MEDIDA | 1000 mm | 1200 mm | | |



ACABADOS DISPONIBLES
ALUMINIO, BLANCO,
NEGRO Y ANTRACITA

| | | | |
|---|--|--|---|
|  | <p>CODIGO / REF. 3638 MED. TALADRO 160 mm</p> <p>COLOR INOX</p> |  | <p>CODIGO / REF. 3639 MED. TALADRO 128 mm</p> <p>COLOR NEGRO</p> |
|  | <p>CODIGO/REF. 3646 MED. TALADRO 192</p> <p>COLOR NEGRO</p> |  | <p>CODIGO / REF. 3647 MED. TALADRO 160</p> <p>COLOR NIQUEL NEGRO</p> |
|  | <p>CODIGO/REF. 3648 MED. TALADRO 160</p> <p>COLOR COBRE NEGRO</p> |  | <p>CODIGO / REF. 3649 MED. TALADRO 160</p> <p>COLOR PLATA ARENA</p> |
|  | <p>CODIGO/REF. 3650 MED. TALADRO 160</p> <p>COLOR OXIDO ARENA</p> |  | <p>CODIGO / REF. 3651 MED. TALADRO 160</p> <p>COLOR CR MATE</p> |
|  | <p>CODIGO/REF. 3652 MED. TALADRO 160</p> <p>COLOR NEGRO</p> |  | <p>CODIGO / REF. 3653 MED. TALADRO 160</p> <p>COLOR BLANCO</p> |
|  | <p>CODIGO/REF. 3654 MED. TALADRO 160</p> <p>COLOR LATON VIEJO</p> |  | <p>CODIGO / REF. 3655 MED. TALADRO 96</p> <p>COLOR PLATA VIEJA</p> |
|  | <p>CODIGO/REF. 3656 MED. TALADRO 32</p> <p>COLOR OXIDO ARENA</p> |  | <p>CODIGO / REF. 3657 MED. TALADRO 32</p> <p>COLOR PLATA ARENA</p> |



CODIGO/REF.
3658
MED. TALADRO
32

COLOR
CROMO MATE



CODIGO / REF.
3659
MED. TALADRO
64

COLOR
PLATA VIEJA



CODIGO/REF.
3660
MED. TALADRO
64

COLOR
COBRE



TIRADOR FORMA

| | | | | | | | | |
|---------------|----------------|----------------|----------------|----------------|----------------|-----------------|-----------------|------------------|
| | | | | | | | | INOX LOOK |
| REF. | 3631/15 | 3631/20 | 3631/25 | 3631/30 | 3631/35 | 3631/40 | 3631/45 | 3631/45 |
| MEDIDA | 150 mm | 200 mm | 250 mm | 300 mm | 350 mm | 400 mm | 450 mm | 450 mm |
| REF. | 3631/50 | 3631/60 | 3631/70 | 3631/80 | 3631/90 | 3631/100 | 3631/120 | 3631/120 |
| MEDIDA | 500 mm | 600 mm | 700 mm | 800 mm | 900 mm | 1000 mm | 1200 mm | 1200 mm |



TIRADOR LINEAL

| | | | | | | | | |
|---------------|----------------|----------------|----------------|----------------|----------------|-----------------|-----------------|------------------|
| | | | | | | | | INOX LOOK |
| REF. | 3663/15 | 3663/20 | 3663/25 | 3663/30 | 3663/35 | 3663/40 | 3663/45 | 3663/45 |
| MEDIDA | 150 mm | 200 mm | 250 mm | 300 mm | 350 mm | 400 mm | 450 mm | 450 mm |
| REF. | 3663/50 | 3663/60 | 3663/70 | 3663/80 | 3663/90 | 3663/100 | 3663/120 | 3663/120 |
| MEDIDA | 500 mm | 600 mm | 700 mm | 800 mm | 900 mm | 1000 mm | 1200 mm | 1200 mm |



TIRADOR VECTOR

| | | | | | | | | |
|---------------|----------------|----------------|----------------|----------------|----------------|-----------------|-----------------|-----------------|
| | | | | | | | | NEGRO |
| REF. | 3662/15 | 3662/20 | 3662/25 | 3662/30 | 3662/35 | 3662/40 | 3662/45 | 3662/45 |
| MEDIDA | 150 mm | 200 mm | 250 mm | 300 mm | 350 mm | 400 mm | 450 mm | 450 mm |
| REF. | 3662/50 | 3662/60 | 3662/70 | 3662/80 | 3662/90 | 3662/100 | 3662/120 | 3662/120 |
| MEDIDA | 500 mm | 600 mm | 700 mm | 800 mm | 900 mm | 1000 mm | 1200 mm | 1200 mm |



TIRADOR GRADA

RECOMENDADO ESPECIALMENTE PARA GOLA PLANO

| | | | | | | | | |
|---------------|----------------|----------------|----------------|----------------|----------------|-----------------|-----------------|------------------|
| | | | | | | | | INOX LOOK |
| REF. | 3661/15 | 3661/20 | 3661/25 | 3661/30 | 3661/35 | 3661/40 | 3661/45 | 3661/45 |
| MEDIDA | 150 mm | 200 mm | 250 mm | 300 mm | 350 mm | 400 mm | 450 mm | 450 mm |
| REF. | 3661/50 | 3661/60 | 3661/70 | 3661/80 | 3661/90 | 3661/100 | 3661/120 | 3661/120 |
| MEDIDA | 500 mm | 600 mm | 700 mm | 800 mm | 900 mm | 1000 mm | 1200 mm | 1200 mm |



| | | | | |
|---|----|--------|--------|---|
| REF. | CO | INDAUX | PUNTOS | 2 |
| JUEGO COLGADOR OCULTO PARA MUEBLE ALTO | | | | |



| | | | | |
|--|------|--------|--------|----|
| REF. | CMBA | INDAUX | PUNTOS | 37 |
| JUEGO COLGADOR PARA MUEBLE BAJO ATLAS | | | | |

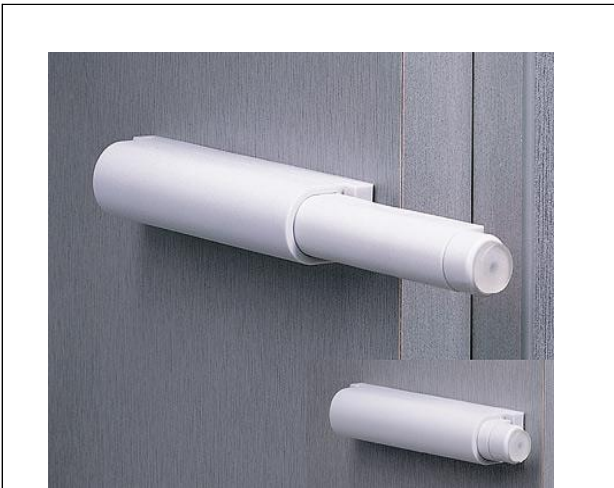

| | | | | |
|--------------------------|----|------|--------|---|
| REF. | PO | ACAB | PUNTOS | 5 |
| SISTEMA PUSH OPEN | | | | |

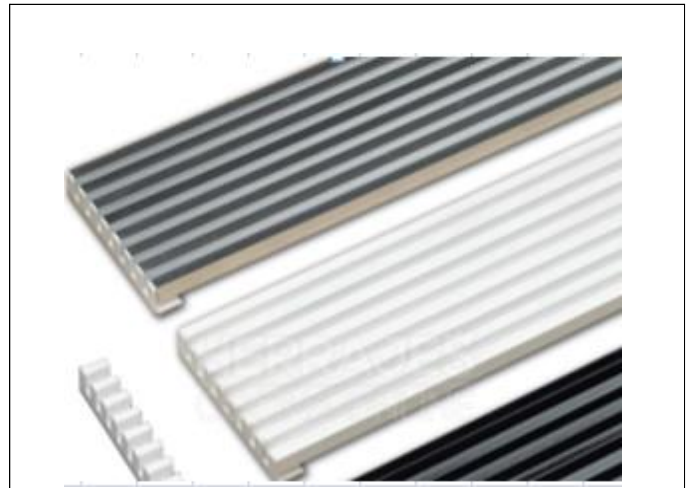

| | | | | | |
|-------------------------------|-----|------|--------|--------|----|
| REF. | RVI | ACAB | INOX | PUNTOS | 18 |
| REF. | RVB | ACAB | BLANCO | PUNTOS | 24 |
| REJILLA DE VENTILACION | | | | | |



| | | | | |
|-----------------------|----|--------|--------|-----|
| REF. | KB | BLANCO | PUNTOS | 35 |
| REF. | KN | NEGRO | PUNTOS | 35 |
| REF. | KI | INOX | PUNTOS | 105 |
| KIT MICROONDAS | | | | |

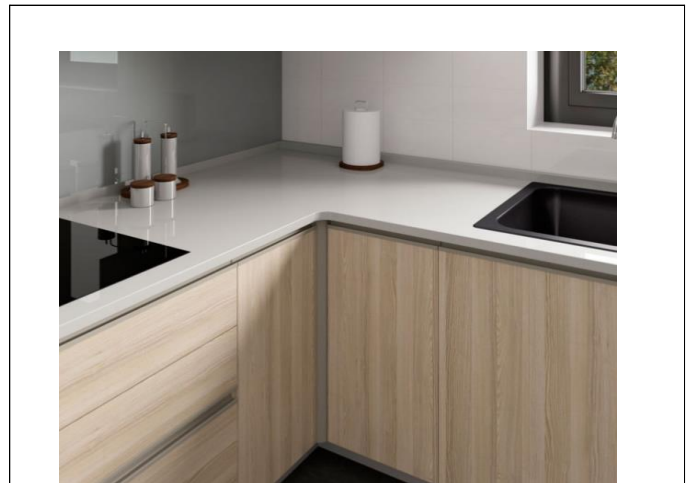

| | | | | |
|------------------|--------------|----------|--------|-----|
| REF. | RINCOMATIC70 | ALUMINIO | PUNTOS | 91 |
| REF. | RINCOMATIC90 | ALUMINIO | PUNTOS | 103 |
| RINCOPLUS | | | | |



| | | | | | |
|---------------------------------------|----------|------|--------|--------|-----|
| REF. | MPA45145 | MED. | 45X150 | PUNTOS | 549 |
| REF. | MPA6090 | MED. | 60X90 | PUNTOS | 552 |
| REF. | MPA60145 | MED. | 60X150 | PUNTOS | 574 |
| MUEBLE PERSIANA COLOR ALUMINIO | | | | | |



ESPECIFICAR COLOR

| | | | | | |
|--|----------|------|--------|--------|-----|
| REF. | MPP60150 | MED. | 60X150 | PUNTOS | 462 |
| REF. | MPP90150 | MED. | 90X150 | PUNTOS | 568 |
| MUEBLE PERSIANA PVC BLANCA-CARBONO-PIZARRA-INOX | | | | | |



| | | | | | |
|--------------------------------|-----------|------|--------|--------|------|
| REF. | MPCB60150 | MED. | 60X150 | PUNTOS | 1132 |
| REF. | MPCN60150 | MED. | 60X150 | PUNTOS | 1132 |
| REF. | MPCS60150 | MED. | 60X150 | PUNTOS | 1132 |
| REF. | MPCB90150 | MED. | 90X150 | PUNTOS | 1368 |
| REF. | MPCN90150 | MED. | 90X150 | PUNTOS | 1368 |
| REF. | MPCS90150 | MED. | 90X150 | PUNTOS | 1368 |
| MUEBLE PERSIANA CRISTAL | | | | | |



REJILLA INDUCCIÓN ALTO 32 90 CM INOX

| | | | | | |
|---|---------|-------|------|--------|----|
| REF. | 0413789 | ACAB. | ÍNOX | PUNTOS | 24 |
| REJILLA INDUCCIÓN ALTO 32 60 CM INOX | | | | | |
| REF. | 0570189 | ACAB. | ÍNOX | PUNTOS | 28 |



| | | | | | |
|--|-------|-------|----------|--------|----|
| REF. | PRC60 | ACAB. | ABS INOX | PUNTOS | 12 |
| PROTECTOR DE COSTADO 60X20X19 ABS ACAB.INOX | | | | | |



| | | | | | |
|---|---------|-------|------------|--------|----|
| REF. | 0413792 | ACAB. | CROMO MATE | PUNTOS | 11 |
| REJILLA AIREAC. ZÓCALO ALTO 70 MM ANCHO 445 MM | | | | | |



| | | | | | |
|---------------------------------------|---------|-------|-----------------|--------|----|
| REF. | SKAIMAN | ACAB. | MET. CROMO MATE | PUNTOS | 32 |
| SOPORTE KAIMAN (SET DOS UDES.) | | | | | |



| | | | | | |
|--|-------|--|------------|--------|----|
| REF. | SKALA | | CROMO MATE | PUNTOS | 36 |
| SOPORTE KALABRONE (SET DOS UDES.) | | | | | |



| | | | | | |
|------------------------------------|--------|-------|------------|--------|----|
| REF. | SPCUBE | ACAB. | CROMO MATE | PUNTOS | 30 |
| SOPORTE CUBE (SET DOS UDES) | | | | | |



| | | | | | |
|--|------|-------|------------|--------|----|
| REF. | SPGP | ACAB. | GRIS PLATA | PUNTOS | 18 |
| SOPORTE PELÍCANO (SET DOS UDES) | | | | | |



| | | | | | |
|-------------------------------|-----|-------|----------|--------|---|
| REF. | PAL | ACAB. | ALUMINIO | PUNTOS | 8 |
| PATA DE ALUMINIO VISTA | | | | | |



| | | | | | |
|-----------------------------|------|-----|-------|--------|---|
| REF. | HULK | H10 | NEGRO | PUNTOS | 3 |
| REF. | HULK | H15 | NEGRO | PUNTOS | 4 |
| PATA HULK JUEGO DE 4 | | | | | |



| | | | | | |
|------|--------|-------|------|--------|-----|
| REF. | HSBLUM | ACAB. | GRIS | PUNTOS | 235 |
|------|--------|-------|------|--------|-----|

ELEVABLE HS



| | | | | | |
|------|--------|-------|------|--------|-----|
| REF. | HLBLUM | ACAB. | GRIS | PUNTOS | 182 |
|------|--------|-------|------|--------|-----|

ELEVABLE HL

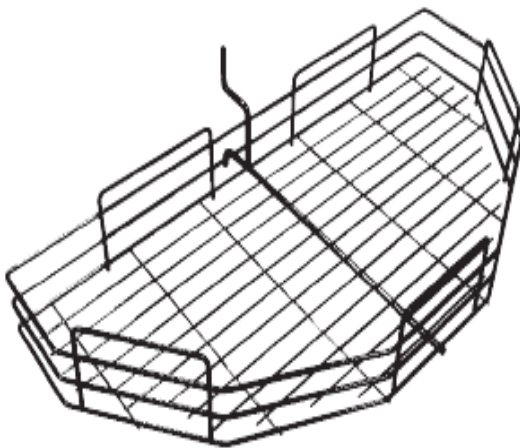

| | | | | | |
|------|------|-------|-------|--------|-----|
| REF. | B180 | ACAB. | CROMO | PUNTOS | 119 |
|------|------|-------|-------|--------|-----|

JUEGO BANDEJAS SEMICIRCULAR 180° RINCON CIEGO



| | | | | |
|------|------|---------------|--------|-----|
| REF. | ML2B | ARENA-CLASSIC | PUNTOS | 326 |
|------|------|---------------|--------|-----|

MEDIA LUNA DOS BANDEJAS MINIMO PUERTA 45

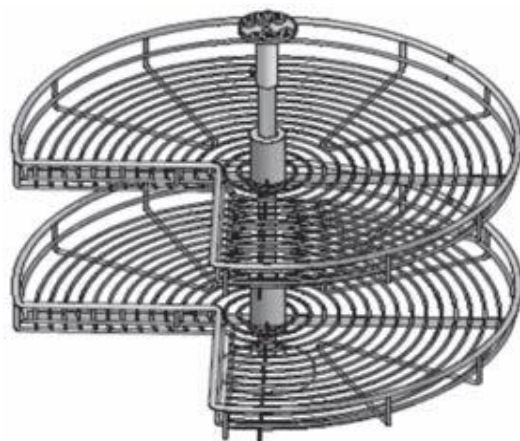

| | | | | | |
|------|------|-------|-------|--------|-----|
| REF. | T270 | ACAB. | CROMO | PUNTOS | 268 |
|------|------|-------|-------|--------|-----|

TORNO 270° GIREVOLE PARA RBA 90X90



| | | | | | |
|------|------|-------|--------------|--------|-----|
| REF. | BTCR | ACAB. | CLASSIC-GRIS | PUNTOS | 488 |
|------|------|-------|--------------|--------|-----|

BANDEJA TRES CUARTOS PARA RBA ANGULAR

KESSEBÖHMER



| | | | | | |
|--|-------|-------|-----------|--------|-----|
| REF. | BTCRA | ACAB. | ANTRACITA | PUNTOS | 524 |
| BANDEJA TRES CUARTOS PARA RBA ANGULAR | | | | | |

KESSEBÖHMER



| | | | | | |
|------|-----------|-------|-----------|--------|-----|
| REF. | LEMANS45A | ACAB. | ANTRACITA | PUNTOS | 758 |
| REF. | LEMANS60A | ACAB. | ANTRACITA | PUNTOS | 876 |

KESSEBÖHMER



CONFORT II ANTRACITA

| | | | | | |
|------|-------|------|----|--------|-----|
| REF. | CCA20 | MED. | 20 | PUNTOS | 404 |
| REF. | CCA30 | MED. | 30 | PUNTOS | 429 |
| REF. | CCA40 | MED. | 40 | PUNTOS | 468 |

KESSEBÖHMER



| | | | | | |
|----------------------------------|--------|-------|-----------|--------|-----|
| REF. | 402707 | ACAB. | ANTRACITA | PUNTOS | 259 |
| EXTRAIBLE DE 15 ANTRACITA | | | | | |

KESSEBÖHMER



| | | | | | |
|-------------------------|---------|-------|-----------|--------|------|
| REF. | 0404307 | ACAB. | ANTRACITA | PUNTOS | 1791 |
| TANDEM ANTRACITA | | | | | |

KESSEBÖHMER



| | | | | | |
|------------------------------|---------|-----|--------|--------|-----|
| REF. | 0403807 | MED | 60X60 | PUNTOS | 473 |
| REF. | 0404007 | MED | 60X170 | PUNTOS | 553 |
| TANDEM SIDE ANTRACITA | | | | | |



| | | | | | |
|--|---------|-------|---------|--------|-----|
| REF. | 0414191 | ACAB. | VARILLA | PUNTOS | 509 |
| DINAMIC CORNER FRENO DCHO PUERTA MINIMO 40 | | | | | |
| REF. | 0414291 | ACAB. | VARILLA | PUNTOS | 509 |
| DINAMIC CORNER FRENO IZDO PUERTA MINIMO 40 | | | | | |

| | | | | | |
|-------------------------------|--------|-------|---------|--------|-----|
| REF. | DUETTO | ACAB. | VARILLA | PUNTOS | 306 |
| DUETTO PARA PUERTA DE 40 - 45 | | | | | |



| | | | | | |
|--|----------|-------|--------------|--------|-----|
| REF. | LEMANS45 | ACAB. | CLASSIC-GRIS | PUNTOS | 724 |
| LEMAMS DOS BANDEJAS PARA PUERTA DE 40-45 | | | | | |
| REF. | LEMANS60 | ACAB. | CLASSIC-GRIS | PUNTOS | 786 |
| LEMAMS DOS BANDEJAS PARA PUERTA DE 50-60 | | | | | |

| | | | | | |
|--------------------------------|---------|-------|---------|--------|-----|
| REF. | 0417591 | ACAB. | VARILLA | PUNTOS | 401 |
| HIDDEN CORNER PUERTA MINIMA 45 | | | | | |



| | | | | |
|-------------------------------|----|---------------|--------|------|
| REF. | MC | ARENA-CLASSIC | PUNTOS | 1160 |
| MAGIC CORNER PUERTA MINIMA 45 | | | | |



| | | | | | |
|--|--------|------|----|--------|-----|
| REF. | EC4C30 | MED. | 30 | PUNTOS | 644 |
| REF. | EC4C40 | MED. | 40 | PUNTOS | 662 |
| REF. | EC4C45 | MED. | 45 | PUNTOS | 685 |
| REF. | EC4C60 | MED. | 60 | PUNTOS | 774 |
| ESTRUCTURA COLUMNA 4 CESTOS DE 113 A 149 | | | | | |



| | | | | | |
|--|--------|------|----|--------|-----|
| REF. | EC6C30 | MED. | 30 | PUNTOS | 723 |
| REF. | EC6C40 | MED. | 40 | PUNTOS | 746 |
| REF. | EC6C45 | MED. | 45 | PUNTOS | 782 |
| REF. | EC6C60 | MED. | 60 | PUNTOS | 893 |
| ESTRUCTURA COLUMNA 6 CESTOS DE 183 A 220 | | | | | |



| | | | | | |
|-------------------------------------|----------|------|-------------|--------|------|
| REF. | CLB45200 | MED. | 45/ 180-200 | PUNTOS | 1737 |
| REF. | CLB45220 | MED. | 45/ 200-220 | PUNTOS | 1746 |
| REF. | CLB60200 | MED. | 60/ 180-200 | PUNTOS | 1877 |
| REF. | CLB60220 | MED. | 60/ 200-220 | PUNTOS | 1886 |
| CONVOY LAVIDO BLANCO CON 5 BANDEJAS | | | | | |



| | | | | | |
|---|---------|-------|----|--------|------|
| REF. | 0421501 | ANCHO | 45 | PUNTOS | 1607 |
| REF. | 0421701 | ANCHO | 50 | PUNTOS | 1714 |
| REF. | 0421901 | ANCHO | 60 | PUNTOS | 1879 |
| K/ SET TANDEM ARENA STYLE ALTO MINIMO 170 | | | | | |



Bandeja aluminio extraible con frontal de madera.

| | | | | | |
|------|---------|----|-----------|---------------|-----|
| REF. | EXTENDO | 60 | ANT/ROBLE | PUNTOS UNIDAD | 280 |
| REF. | EXTENDO | 90 | ANT/ROBLE | PUNTOS UNIDAD | 348 |



| | | | | | |
|---|---------|------|------|--------|-----|
| REF. | 0426320 | ACAB | GRIS | PUNTOS | 165 |
| CLEANIG AGENT ANCHO 30 CM GUIA BASAL PARA AJUSTAR A CUALQUIER ANCHO | | | | | |



| | | | | | |
|---------------------------------|---------|------|----|--------|-----|
| REF. | 0410491 | MED. | 30 | PUNTOS | 177 |
| REF. | 0410591 | MED. | 35 | PUNTOS | 185 |
| REF. | 0410691 | MED. | 40 | PUNTOS | 185 |
| REF. | 0410791 | MED. | 45 | PUNTOS | 193 |
| BOTELLERO PANERO C/FRENO | | | | | |



| | | | | | |
|--------------------------------------|---------|------|------|--------|-----|
| REF. | 0426420 | ACAB | GRIS | PUNTOS | 358 |
| COOKING AGENT PARA BAJO DE 30 | | | | | |



| | | | | | |
|--------------------------------|-------|------|----|--------|-----|
| REF. | CCG20 | MED. | 20 | PUNTOS | 375 |
| REF. | CCG30 | MED. | 30 | PUNTOS | 410 |
| REF. | CCG40 | MED. | 40 | PUNTOS | 432 |
| COMFORT II CLASSIC GRIS | | | | | |



| | | | | | |
|---|---------|------|----|--------|-----|
| REF. | 0414491 | MED. | 30 | PUNTOS | 198 |
| REF. | 0414791 | MED. | 45 | PUNTOS | 210 |
| REF. | 0414991 | MED. | 60 | PUNTOS | 258 |
| EXTRAIBLE 3 CESTAS C/FRENO CROMO | | | | | |



| | | | | | |
|-------------------------------------|---------|------|----|--------|-----|
| REF. | 0420191 | MED. | 30 | PUNTOS | 181 |
| REF. | 0420291 | MED. | 40 | PUNTOS | 186 |
| EXTRAÍBLE BOTELLERO 2 CESTAS | | | | | |



| | | | | | |
|-------------------------------------|---------|------|----|--------|-----|
| REF. | 0415091 | MED. | 15 | PUNTOS | 100 |
| REF. | 0415291 | MED. | 20 | PUNTOS | 125 |
| REF. | 0415391 | MED. | 25 | PUNTOS | 155 |
| MINIBOTELLERO FRENO 50 FONDO | | | | | |



| | | | | | |
|---------------------------------------|---------|------|----|--------|-----|
| REF. | 0413391 | MED. | 45 | PUNTOS | 118 |
| REF. | 0413591 | MED. | 60 | PUNTOS | 131 |
| REF. | 0413791 | MED. | 90 | PUNTOS | 153 |
| CESTOS MULTIUSOS VARILLA CROMO | | | | | |



| | | | | | |
|------------------------------------|---------|------|----|--------|-----|
| REF. | 0411391 | MED. | 60 | PUNTOS | 156 |
| CACEROLERO VARILLA CROMO 60 | | | | | |



| | | | | | |
|------------------------------------|---------|------|----|--------|-----|
| REF. | 0415691 | MED. | 60 | PUNTOS | 168 |
| REF. | 0415891 | MED. | 90 | PUNTOS | 181 |
| SALVA-SIFONES C/FRENO CROMO | | | | | |



| | | | | | |
|--|---------|------|----|--------|-----|
| REF. | 0411991 | MED. | 60 | PUNTOS | 330 |
| ESCURREPLATOS EXT C/FRENO CROMO | | | | | |



| | | | | | |
|---------------------------------------|---------|------|----|--------|-----|
| REF. | 0461691 | MED. | 40 | PUNTOS | 149 |
| REF. | 0461791 | MED. | 45 | PUNTOS | 156 |
| REF. | 0461891 | MED. | 60 | PUNTOS | 183 |
| CESTA ROPA EXTRAIBLE *45 FONDO | | | | | |



| | | | | | |
|--------------------------------------|---------|------|----|--------|----|
| REF. | 0416591 | MED. | 40 | PUNTOS | 77 |
| REF. | 0416691 | MED. | 45 | PUNTOS | 77 |
| REF. | 0416891 | MED. | 60 | PUNTOS | 84 |
| CESTA ROPA ABATIBLE *27 FONDO | | | | | |

TIPOS DE CAJON



CAJON Y CACEROLERO CON FRENO DE SERIE MARCA HETTICH ATIRA FONDO 500.

ACABADOS DISPONIBLES PLATA ANTRACITA Y BLANCO AL MISMO PRECIO.



CAJON Y CACEROLERO CON FRENO MARCA HETTICH ARCITECH FONDO 500.

ACABADOS DISPONIBLES PLATA, ANTRACITA Y BLANCO. TODOS LOS ACABADOS IGUAL PRECIO.

INCREMENTOS EN PAGINA SIGUIENTE.



CAJON Y CACEROLERO CON FRENO BLUM LEGRABOX. PARED DE 12 MM Y EN DIFERENTES ALTURAS.

ACABADO DISPONIBLE ANTRACITA. INCREMENTOS EN PAGINA SIGUIENTE.



| | | | |
|-------------------|-------|--------|----|
| CAJON ARCITECH | PLATA | PUNTOS | 18 |
| CACEROL. ARCITECH | PLATA | PUNTOS | 22 |



| | | | | | |
|-----------------------------|-------------|--|-----------|--------|----|
| REF. | DESIGN SIDE | | ANTRACITA | PUNTOS | 30 |
| ARCITECH DESIGN SIDE | | | | | |



| | | | |
|---------------|--------------------|--------|----|
| CAJON BLUM | LEGRABOX ANTRACITA | PUNTOS | 36 |
| CACEROL. BLUM | LEGRABOX ANTRACITA | PUNTOS | 44 |



| | | | | | |
|---|--------|------|----|--------|-----|
| REF. | CILG45 | MED. | 45 | PUNTOS | 126 |
| REF. | CILG50 | MED. | 50 | PUNTOS | 128 |
| REF. | CILG60 | MED. | 60 | PUNTOS | 130 |
| CACEROLERO INTERIOR LEGRABOX PARA DESPENSERO | | | | | |



| | | | | | |
|--|--------|------|----|--------|----|
| REF. | CIAT45 | MED. | 45 | PUNTOS | 78 |
| REF. | CIAT50 | MED. | 50 | PUNTOS | 80 |
| REF. | CIAT60 | MED. | 60 | PUNTOS | 82 |
| CACEROLERO INTERIOR ATIRA PARA DESPENSERO | | | | | |



| | | | | | |
|---|--------|------|----|--------|-----|
| REF. | CIAR45 | MED. | 45 | PUNTOS | 126 |
| REF. | CIAR50 | MED. | 50 | PUNTOS | 128 |
| REF. | CIAR60 | MED. | 60 | PUNTOS | 130 |
| CACEROLERO INTERIOR ARCITECH PARA DESPENSERO | | | | | |

CUBERTERO MADERA FENOLICA ACABADO HAYA



| | | | | |
|------|----------|------------------|--------|-----|
| REF. | CUBMF30 | TABLERO FENOLICO | PUNTOS | 71 |
| REF. | CUBMF35 | TABLERO FENOLICO | PUNTOS | 79 |
| REF. | CUBMF40 | TABLERO FENOLICO | PUNTOS | 87 |
| REF. | CUBMF45 | TABLERO FENOLICO | PUNTOS | 92 |
| REF. | CUBMF50 | TABLERO FENOLICO | PUNTOS | 122 |
| REF. | CUBMF60 | TABLERO FENOLICO | PUNTOS | 129 |
| REF. | CUBMF90 | TABLERO FENOLICO | PUNTOS | 179 |
| REF. | CUBMF120 | TABLERO FENOLICO | PUNTOS | 248 |

CUBERTERO OPEN ACABADO ROBLE Y METAL NEGRO



| | | | | |
|------|------------|-------------------|--------|-----|
| REF. | CUBOPEN30 | ROBLE/METAL NEGRO | PUNTOS | 148 |
| REF. | CUBOPEN40 | ROBLE/METAL NEGRO | PUNTOS | 178 |
| REF. | CUBOPEN45 | ROBLE/METAL NEGRO | PUNTOS | 181 |
| REF. | CUBOPEN50 | ROBLE/METAL NEGRO | PUNTOS | 209 |
| REF. | CUBOPEN60 | ROBLE/METAL NEGRO | PUNTOS | 213 |
| REF. | CUBOPEN70 | ROBLE/METAL NEGRO | PUNTOS | 293 |
| REF. | CUBOPEN80 | ROBLE/METAL NEGRO | PUNTOS | 370 |
| REF. | CUBOPEN90 | ROBLE/METAL NEGRO | PUNTOS | 374 |
| REF. | CUBOPEN120 | ROBLE/METAL NEGRO | PUNTOS | 485 |

ORGANIZADOR CACEROLERO OPEN ACABADO ROBLE/METAL NEGRO



| | | | | |
|------|------------|-------------------|--------|-----|
| REF. | CACOPEN60 | ROBLE/METAL NEGRO | PUNTOS | 200 |
| REF. | CACOPEN70 | ROBLE/METAL NEGRO | PUNTOS | 253 |
| REF. | CACOPEN80 | ROBLE/METAL NEGRO | PUNTOS | 253 |
| REF. | CACOPEN90 | ROBLE/METAL NEGRO | PUNTOS | 255 |
| REF. | CACOPEN120 | ROBLE/METAL NEGRO | PUNTOS | 349 |

MARCO TELESCOPICO EXTENSIBLE DE 236 A 386 mms.



| | | | | |
|------|--------|-----------|--------|-----|
| REF. | 5080.1 | GRIS | PUNTOS | 162 |
| REF. | 5080.2 | BLANCO | PUNTOS | 162 |
| REF. | 5080.3 | ANTRACITA | PUNTOS | 162 |

CAJA MADERA ORGANIZADOR PARA CACEROLERO NOGAL



| | | | | |
|------|---------|-------------|--------|-----|
| REF. | L2419NL | 240X230X190 | PUNTOS | 100 |
| REF. | L2446NL | 240X460X190 | PUNTOS | 133 |
| REF. | L3019NL | 300X230X190 | PUNTOS | 111 |

ACCESORIO FRUTA Y VERDURA PARA CACEROLERO 60



| | | | | |
|------|------------|--------|--------|-----|
| REF. | HA-3690-60 | BLANCO | PUNTOS | 587 |
|------|------------|--------|--------|-----|

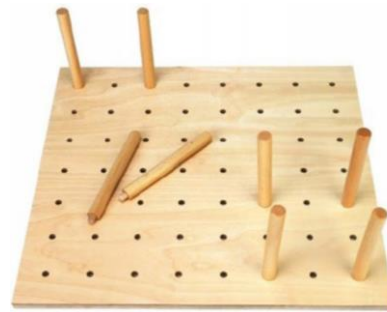

FONDO PERFORADO + PIVOTES

| | | | | |
|------|---------|---------------|--------|-----|
| REF. | FMPF60 | T.MARINO 60 | PUNTOS | 54 |
| REF. | FMPF90 | T.MARINO 90 | PUNTOS | 79 |
| REF. | FMPF120 | T.MARINO 120 | PUNTOS | 101 |
| REF. | CFMP15 | PIVOTE MADERA | PUNTOS | 5 |



| | | | | | |
|------|---------|-------|-------------|--------|-----|
| REF. | 0600920 | ACAB. | INOX-BLANCO | PUNTOS | 723 |
|------|---------|-------|-------------|--------|-----|

MESA LUNCH PARA B-90 EXTRACCION 80 CM
CARGA 60KG FONDO MINIMO DE MUEBLE 54



| | | | | | |
|------|---------|-------|--------|--------|-----|
| REF. | 3845601 | ACAB. | BLANCO | PUNTOS | 447 |
|------|---------|-------|--------|--------|-----|

MESA PARA B-60 EXTRACCION 80 CM
FONDO MINIMO DE MUEBLE 54



| | | | | |
|------|---------|-------------|--------|----|
| REF. | 0412720 | BLANCO-GRIS | PUNTOS | 30 |
|------|---------|-------------|--------|----|

CONTENEDOR DE BASURA REDONDO DE 12 L.



| | | | | |
|------|---------|------|--------|----|
| REF. | 0524489 | INOX | PUNTOS | 70 |
|------|---------|------|--------|----|

CUBO PUERTA ÍNOX



| | | | | |
|------|---------|--------------|--------|----|
| REF. | 0411620 | BLANCO-NEGRO | PUNTOS | 68 |
|------|---------|--------------|--------|----|

CONTENEDOR DE BASURA EXTRAIBLE DE 17 L.



| | | | | |
|------|---------|--------|--------|-----|
| REF. | 0411720 | BLANCO | PUNTOS | 104 |
|------|---------|--------|--------|-----|

CONTENEDOR DE BASURA DOBLE DE 17 + 17 L.



| | | | | |
|------|---------|--------|--------|-----|
| REF. | 0411820 | BLANCO | PUNTOS | 113 |
|------|---------|--------|--------|-----|

CONTENEDOR DE BASURA TRIPLE DE 17+8,5+8,5 L.



| | | | | |
|------|---------|------|--------|----|
| REF. | 0412220 | GRIS | PUNTOS | 95 |
|------|---------|------|--------|----|

CONTENEDOR DE BASURA DE 17 + 17 L.
PARA MUEBLE DE 60 CACEROLERO



| | | | | |
|--|---------|------------|--------|-----|
| REF. | 0412420 | GRIS-VERDE | PUNTOS | 122 |
| CONTENEDOR DE BASURA 17+17+17 L PARA CAC-90 | | | | |
| REF. | 0412420 | GRIS-VERDE | PUNTOS | 140 |
| CONTENEDOR DE BASURA 17+17+17 L PARA CAC-100 | | | | |



| | | | | |
|---------------------------------------|---------|------|--------|----|
| REF. | 0411489 | INOX | PUNTOS | 64 |
| CUBO PARA ENCASTRAR EN ENCIMERAS 8 L. | | | | |



| | | | | |
|-------------------------------------|---------|------|--------|-----|
| REF. | CB2X30L | GRIS | PUNTOS | 398 |
| CUBO EURO CARGO CAPACIDAD 30 L/CUBO | | | | |

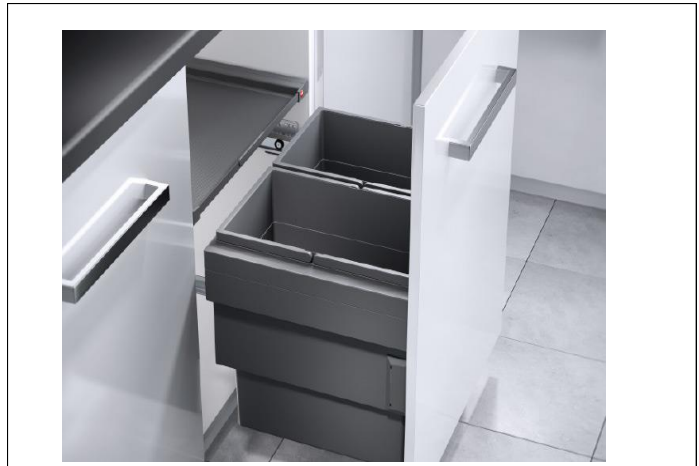

| | | | | |
|-------------------------------------|----------|-----------|--------|-----|
| REF. | CB2X30LA | ANTRACITA | PUNTOS | 398 |
| CUBO EURO CARGO CAPACIDAD 30 L/CUBO | | | | |



| | | | | |
|--|---------|------|--------|-----|
| REF. | 0412820 | GRIS | PUNTOS | 239 |
| CUBO BASURA GRAN CAPACIDAD MAGNUM PARA B-45 PTA EXTRAIBLE 48 LITROS POR CUBETA | | | | |



ESTRUCTURA METALICA INCLUYE PORTACOPAS

| | | | | | |
|------|-----------|------|--------|--------|------|
| REF. | 521360136 | MED. | 60X130 | PUNTOS | 1370 |
| REF. | 521390136 | MED. | 90X130 | PUNTOS | 1700 |



SOLO ESTRUCTURA TABLERO APARTE (MODELO PUERTA)

| | | | | | |
|------|---------|------|-----------|--------|-----|
| REF. | AURA45 | MED. | 45X45X35 | PUNTOS | 175 |
| REF. | AURA60 | MED. | 60X45X35 | PUNTOS | 184 |
| REF. | AURA90 | MED. | 90X45X35 | PUNTOS | 197 |
| REF. | AURA120 | MED. | 120X45X35 | PUNTOS | 209 |



SOLO ESTRUCTURA TABLERO APARTE (MODELO PUERTA)

| | | | | | |
|------|-----------|------|-------------|--------|-----|
| REF. | 403002003 | MED. | 98X40 FONDO | PUNTOS | 174 |
|------|-----------|------|-------------|--------|-----|

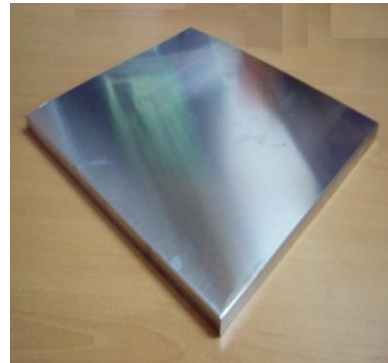

| | | | | | | |
|------|--------|------|-------|------|--------|----|
| REF. | PCL23I | MED. | 33x23 | INOX | PUNTOS | 23 |
| REF. | PCL23B | MED. | 33x23 | BLCO | PUNTOS | 23 |
| REF. | PCL70I | MED. | 33x70 | INOX | PUNTOS | 65 |
| REF. | PCL90I | MED. | 33X90 | INOX | PUNTOS | 80 |

JUEGO PROTECTOR CAMPANA



| | | | | | |
|------|--------|------|-----|--------|-----|
| REF. | BNL60 | MED. | 60 | PUNTOS | 357 |
| REF. | BNL90 | MED. | 90 | PUNTOS | 413 |
| REF. | BNL120 | MED. | 120 | PUNTOS | 497 |

BASE NEBULA LED *32 ALUMINIO C/TRANSFORMADOR



| | | | | | |
|------|---------|------|-----|--------|-----|
| REF. | 0700887 | MED. | 60 | PUNTOS | 316 |
| REF. | 0700987 | MED. | 90 | PUNTOS | 371 |
| REF. | 0701087 | MED. | 120 | PUNTOS | 448 |

ESTANTE WING TLD *22 ALUM. C/TRANSFORMADOR



| | | | | | |
|------|---------|-------|----------|--------|-----|
| REF. | 0701287 | ACAB. | ALUMINIO | PUNTOS | 265 |
|------|---------|-------|----------|--------|-----|

SET 3 FOCOS SKATE 1.6 W C/TOUCH LED C/ALIMENTADOR



| | | | | | |
|------|---------|-------|----------|--------|-----|
| REF. | 0701487 | ACAB. | ALUMINIO | PUNTOS | 265 |
|------|---------|-------|----------|--------|-----|

SET 3 FOCOS LED KAYAK C/TOUCH LED C/ ALIMENTADOR



| | | | | | |
|------|---------|-------|----------|--------|-----|
| REF. | 0701687 | ACAB. | ALUMINIO | PUNTOS | 265 |
|------|---------|-------|----------|--------|-----|

SET 3 FOCOS LED SMARTY C/TOUCH LED C/ALIMENTADOR



| | | | | | |
|------|-------|-------|----------|--------|-----|
| REF. | POLAR | ACAB. | ALUMINIO | PUNTOS | 147 |
|------|-------|-------|----------|--------|-----|

SET 2 FOCOS POLAR SIN SENSOR C/ALIMENTADOR



PERFIL ALUMINIO CON LED SUPERFICIE
INCLUYE SENSOR TACTIL Y TRANSFORMADOR

| | | | | | |
|------|---------|------|-----|--------|-----|
| REF. | LEDS60 | MED. | 60 | PUNTOS | 106 |
| REF. | LEDS90 | MED. | 90 | PUNTOS | 118 |
| REF. | LEDS120 | MED. | 120 | PUNTOS | 137 |
| REF. | LEDS150 | MED. | 150 | PUNTOS | 146 |



PERFIL ALUMINIO CON LED ENCASTRAR
INCLUYE SENSOR TACTIL Y TRANSFORMADOR

| | | | | | |
|------|---------|------|-----|--------|-----|
| REF. | LEDE60 | MED. | 60 | PUNTOS | 106 |
| REF. | LEDE90 | MED. | 90 | PUNTOS | 118 |
| REF. | LEDE120 | MED. | 120 | PUNTOS | 137 |
| REF. | LEDE150 | MED. | 150 | PUNTOS | 146 |

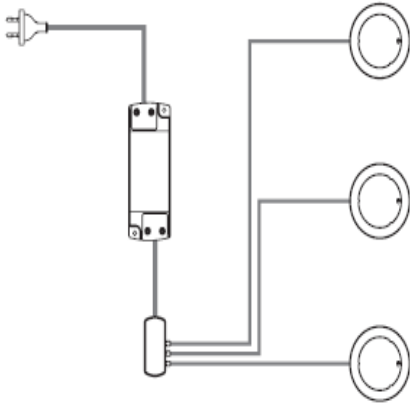

| | | | | |
|-------------------------------------|---------|--|--------|----|
| REF. | 0701401 | | PUNTOS | 42 |
| KIT TRANSFORMADOR 15/12 220-240/12V | | | | |



| | | | | | |
|--|---------|------|----------|--------|-----|
| REF. | 0701887 | MED. | 60-2,6 W | PUNTOS | 166 |
| REF. | 0701987 | MED. | 90-4,1W | PUNTOS | 199 |
| REF. | 0702087 | MED. | 120-5,5W | PUNTOS | 232 |
| NECESITA TRANSFORMADOR REGLETA LED LEAF ALUMINIO C/SENSOR | | | | | |

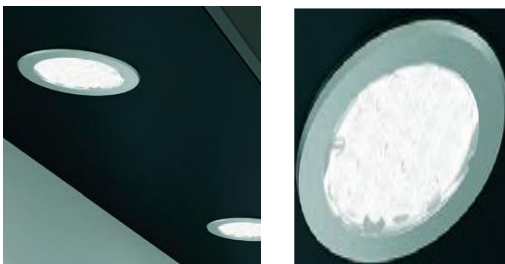

NECESITA TRANSFORMADOR

| | | | | |
|-----------------------------|----|------------|--------|----|
| REF. | FM | CROMO MATE | PUNTOS | 31 |
| FOCO ATALAYA EMBUTIDO 1,6 W | | | | |



NECESITA TRANSFORMADOR

| | | | | |
|-------------------------|-----|------------|--------|----|
| REF. | FSR | CROMO MATE | PUNTOS | 38 |
| FOCO ATALAYA SUP. 1,6 W | | | | |



SET DE 3 LED CON INTERRUPTOR Y TRANSFORMADOR

| | | | | |
|------|--------|--------------|--------|-----|
| REF. | F3MLED | SET DE 3 C/I | PUNTOS | 484 |
|------|--------|--------------|--------|-----|

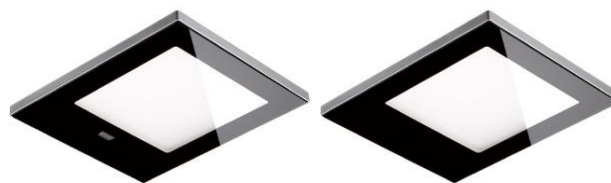

| | | | | | |
|------|---------|-----|-----------------|--------|-----|
| REF. | FMLEL | 4W | SIN INTERRUPTOR | PUNTOS | 138 |
| REF. | FIMLED | 4W | CON INTERRUPTOR | PUNTOS | 163 |
| REF. | TRLEDCR | 15W | TRANSFORMADOR | PUNTOS | 45 |



| | | | | | |
|------|---------|-------|----------|--------|-----|
| REF. | 0700287 | ACAB. | ALUMINIO | PUNTOS | 204 |
|------|---------|-------|----------|--------|-----|

EVOLINE PORT REDONDO INCASSO 3 ENCHUFES



| | | | | | |
|------|---------|-------|------|--------|-----|
| REF. | 0700690 | ACAB. | ÍNOX | PUNTOS | 188 |
|------|---------|-------|------|--------|-----|

ENCHUFE TWIST INOX 2 TOMAS



| | | | | |
|------|--------|-----------------|--------|----|
| REF. | PBCM83 | GRIS MATE | PUNTOS | 22 |
| REF. | PBNS83 | NIQUEL SATINADO | PUNTOS | 22 |
| REF. | PBB83 | BLANCO | PUNTOS | 18 |
| REF. | PBN83 | NEGRO | PUNTOS | 18 |

PIE DE BARRA - 83 DE ALTURA





| | | | | |
|------|----|-------------------|--------|----|
| REF. | EA | ESCUADRA ABATIBLE | PUNTOS | 23 |
|------|----|-------------------|--------|----|

PERFIL GOLA COLOR / ALUMINIO / BLANCO / NEGRO / ANTRACITA



ESTE PERFIL SE PUEDE APLICAR PARA NUESTROS MODELOS DE PUERTAS LISAS
LOS MUEBLES BAJOS CON GOLA TENDRAN UNA ALTURA DE 80 CM

| DISEÑO | REFERENCIA | DESCRIPCIÓN | ACABADO | PUNTOS |
|--|------------|------------------------|---------------|--------|
|  | GOLA | PERFIL GOLA "U" | ALUMINIO MATE | 20 |
| | GOLAB | (PRECIO METRO LINEAL) | BLANCO | 27 |
| | GOLAN | TIRAS DE 4 METROS | NEGRO | 27 |
| | GOLAAT | | ANTRACITA | 27 |

| DISEÑO | REFERENCIA | DESCRIPCIÓN | ACABADO | PUNTOS |
|---|------------|------------------------|---------------|--------|
|  | GOLAJ | PERFIL GOLA "J" | ALUMINIO MATE | 15 |
| | GOLAJB | (PRECIO METRO LINEAL) | BLANCO | 27 |
| | GOLAJN | TIRAS DE 4 METROS | NEGRO | 27 |
| | GOLAJAT | | ANTRACITA | 27 |

| DISEÑO | REFERENCIA | DESCRIPCIÓN | ACABADO | PUNTOS |
|---|------------|--------------------------|---------------|--------|
|  | GOLAP | PERFIL GOLA PLANO | ALUMINIO MATE | 27 |
| | GOLAPB | (PRECIO METRO LINEAL) | BLANCO | 30 |
| | GOLAPN | TIRAS DE 4 METROS | NEGRO | 30 |
| | GOLAPAT | | ANTRACITA | 30 |

PARA INSTALAR EL PERFIL GOLA PLANO SE RECOMIENDA TIRADOR GRADA EN LA PUERTA O PUERTA 45°

| DISEÑO | REFERENCIA | DESCRIPCIÓN | ACABADO | PUNTOS |
|---|------------|--------------------------------|---------------|--------|
|  | PMA | PERFIL GOLA MUEBLE ALTO | ALUMINIO MATE | 13 |
| | | (PRECIO METRO LINEAL) | BLANCO | 15 |
| | | TIRAS DE 3 METROS | NEGRO | 15 |
| | | | ANTRACITA | 15 |

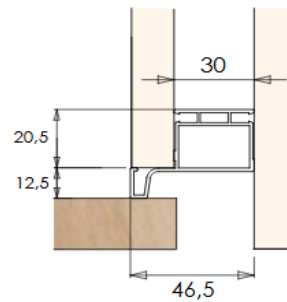
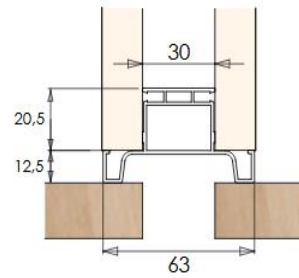

| DISEÑO | REFERENCIA | DESCRIPCIÓN | ACABADO | PUNTOS |
|---|------------|----------------------------|---------------|--------|
|  | GOLAV | PERFIL GOLA CENTRAL | ALUMINIO MATE | 35 |
| | GOLAVB | (PRECIO METRO LINEAL) | BLANCO | 46 |
| | GOLAVN | TIRAS DE 2,55 MTROS | NEGRO | 46 |
| | GOLAVAT | | ANTRACITA | 46 |

| DISEÑO | REFERENCIA | DESCRIPCIÓN | ACABADO | PUNTOS |
|---|------------|----------------------------|---------------|--------|
|  | GOLAL | PERFIL GOLA LATERAL | ALUMINIO MATE | 28 |
| | GOLALB | (PRECIO METRO LINEAL) | BLANCO | 40 |
| | GOLALN | TIRAS DE 2,55 MTROS | NEGRO | 40 |
| | GOLALAT | | ANTRACITA | 40 |

| | | | | |
|---|--------|-------------------------------|---------------|---|
|  | SPGOLA | SOPORTE CLIP SUJECCION | ALUMINIO MATE | 3 |
| | | | BLANCO | |
| | | | NEGRO | |
| | | | ANTRACITA | |

| | | | | |
|--|-------|--------------|-------------|---|
|  | RGOLA | RINCON GOLA | DISPONIBLE | 3 |
| | EGOLA | ESQUINA GOLA | EN ACABADOS | 3 |
| | TGOLA | TAPA GOLA | ANTERIORES | 3 |

CONSIDERACIONES

REFERENCIA

INCREMENTOS POR ADAPTACIÓN DEL CASCO

| | | | |
|-------------|---|-----------|--------|
| | * Incrementos a muebles especiales de fondo | | |
| IF | Muebles altos ó bajos de menos fondo | 27 | PUNTOS |
| IFC | Muebles columna | 38 | PUNTOS |
| | * Incrementos a muebles con mas fondo | | |
| IFA+ | Muebles altos con fondo + de 33 a 58 cm. | 42 | PUNTOS |
| IFB+ | Muebles bajos con fondo + de 58 a 70 cm. | 58 | PUNTOS |
| IFC+ | Muebles columna con fondo + de 58 a 70 cm. | 88 | PUNTOS |
| | * Incrementos a muebles con mueca | | |
| IM | Muebles altos ó bajos con mueca | 52 | PUNTOS |
| IMC | Muebles columna con mueca | 72 | PUNTOS |

INCREMENTOS POR ADAPTACIÓN DEL CASCO Y PUERTA

* Incrementos a muebles especiales

Muebles especial en alto o ancho, estractificados y melaminas + **25%** inmediato superior

Muebles especial alto o ancho en polilaminados, maderas y lacados + **30%** inmediato superior

Muebles en chaflan, estractificados y melaminas + **30%** inmediato superior

Muebles en chaflan, polilaminados, maderas y lacados + **35%** inmediato superior

- * Todos los muebles están valorados sin tirador, por lo que hay que incrementar el precio del mismo. Dicho precio está en la tarifa de tiradores y siempre se cobrará aparte de los muebles. El precio variará dependiendo de la categoría y del diseño.
- * Los pedidos se deben pasar por correo electrónico
- * Los modelos que por defecto se fabrican con armazon blanco y se pidan con el armazon en diseño tendran un incremento de un 4 %.
- * Todos los muebles tienen un codigo , una descripción y un precio en puntos, La forma de saber el codigo de un articulo mirando nuestra tarifa es la siguiente.

| | |
|-------------------------|---|
| 1ª CODIGO MODELO | Desde la serie 100 a la 603 |
| 2ª REF. | Formado por letras |
| 3ª ANCHO | Anchura del mueble |
| 4ª ALTO | Altura del mueble (excepto muebles bajos) |
| 5ª 1P | Solo en caso de muebles de 60 de ancho |

Estos datos estan en **negrita** en nuestra tarifa

- * Los pedidos se consideran en firme , una vez trascurridas 24 horas desde su recepcion del mismo en nuestras oficinas y no se admitiran cambios ni anulaciones de modulos ni puertas que se consideren especiales.
- * En los modelos de madera , al ser producto naturales , pueden tener cambios de color o tonalidad, por lo que un cambio de dichas características, no supone que sea un producto defectuoso.

**CONDICIONES GENERALES DE VENTA
EDICIÓN - 06 / 2019 - JUNIO**

Toda la tarifa esta cotizada en puntos. El precio del punto es de:

0,495 EUROS

* Se podra optar por las siguientes formas de pago

RECIBO BANCARIO 30 DIAS DE FACTURA..... 1,5%

Para obras y exposiciones pueden existir ofertas especiales. Para ello deberan dirigirse a nuestro departamento comercial

PASOS PARA REALIZAR MEJOR SUS PEDIDOS

1. El cliente debe reflejar la dirección, población y fecha; además de la referencia de su cliente válida para ayudar a localizar su pedido en posibles reclamaciones.
2. Indicar el modelo o serie junto con el número de tarifa:
 - ⇒ Si es un modelo de melamina o estratificado, hay que tener en cuenta si va combinado con otro, indicando en la columna de color los muebles del modelo que menos predomina (líneas 2,8 y 12).Tambien hay que tener en cuenta el canto de ambos modelos ya que pueden tener el mismo, distinto o a juego con la puerta.
 - ⇒ Si es de madera o laca indicar el color y el acabado.
3. En la relación de muebles es muy importante colocar primero los muebles altos, luego los bajos y por ultimo los columnas (siempre con las referencias de la tarifa). Además poner la mano (I_D) si es izquierdo o derecho (líneas 1,9,10,11 y 14), si algún mueble es de fondo diferente al normal indicar su fondo en (F.C) (líneas 2 y 10) y no olvidar incluir a que lado del mueble van los costados vistos si es que los hay, en la columna de COST. VIS (líneas 3 y 10).

Según sea el tipo de mueble destacaremos una serie de características en su descripción:

- ⇒ Muebles vitrina: Indicaremos el tipo de cristal (línea 2).
 - ⇒ Muebles escurreplatos (línea 4): Material de las varillas (inox, epoxi blanco) y si llevan bandeja vierteaguas. Si son inox hay que aumentar la varilla inox según medida I.EI . (línea 5)
 - ⇒ Muebles fregadero (línea 11): si llevan bandeja.
 - ⇒ Reflejar en rinconeras altas si son normales o angulares. (línea 6).
 - ⇒ En los muebles de cajones y caceroleros reflejaremos el tipo de cajon que puede ser metálico o metálico con frenos (líneas 12 y 13).
 - ⇒ En soportes placa indicar si lleva rejilla de ventilación con su color (inox, blanca, negra) o regleta.
 - ⇒ En columnas si las puertas no tienen medida normal y son especiales indicar la medida de las mismas.
 - ⇒ En las rinconeras bajas hay que especificar el lado al que va la parte ciega y la medida de la puerta que abre.
 - ⇒ Para los muebles especiales recomendamos realizar un dibujo con todas sus medidas.
4. Indicaremos en los complementos las puertas costado, galerias Etc.
 5. En los elementos lineales no debemos olvidar los colores y modelos. Sobretudo en las encimeras indicando el modelo y el grupo asi como si llevan algun corte o mecanización.
 6. Por último reflejar bien en el pedido la cantidad de patas, chapas, tiradores en caso que lleven y si van colocados en la puerta o sueltos (tiradores).

MEDIDAS

ALTURA TOTAL : 216

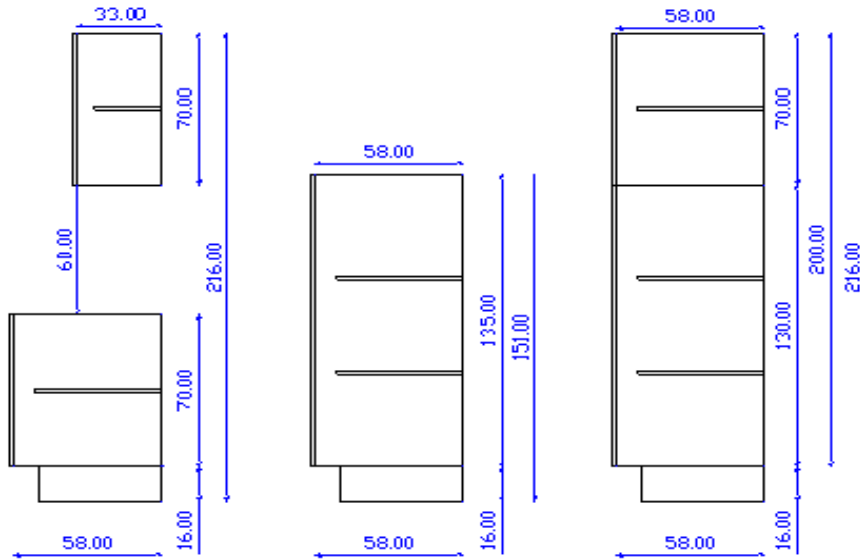

MODULOS
EXTRAPLANAS
ALTURA TOTAL :216

MODULOS
ALTO 70
ALTURA TOTAL :216

MODULOS
SEMICOLUMNAS
ALTURA TOTAL :216

MODULOS
COLUMNAS
ALTURA TOTAL :216

ALTURA TOTAL : 236

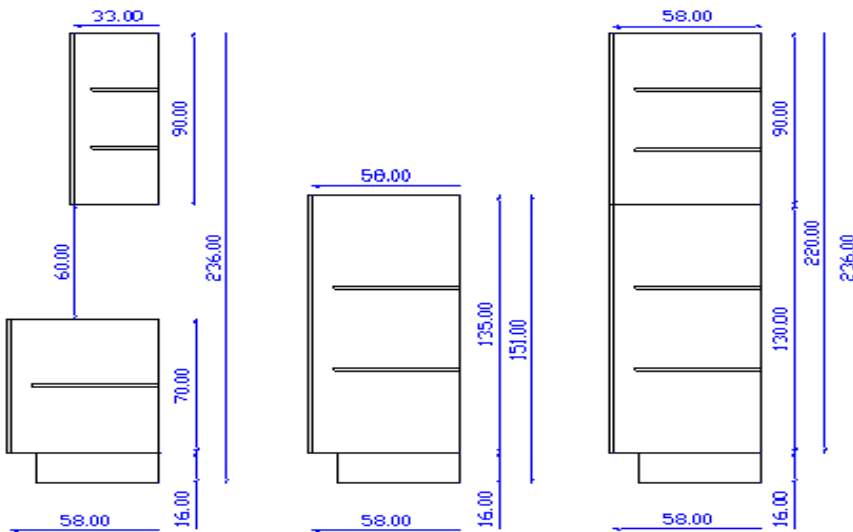

MODULOS
EXTRAPLANAS
ALTURA TOTAL :236

MODULOS
ALTO 90
ALTURA TOTAL :236

MODULOS
SEMICOLUMNAS
ALTURA TOTAL :236

MODULOS
COLUMNAS
ALTURA TOTAL :236

MEDIDAS

ALTURA TOTAL : 230

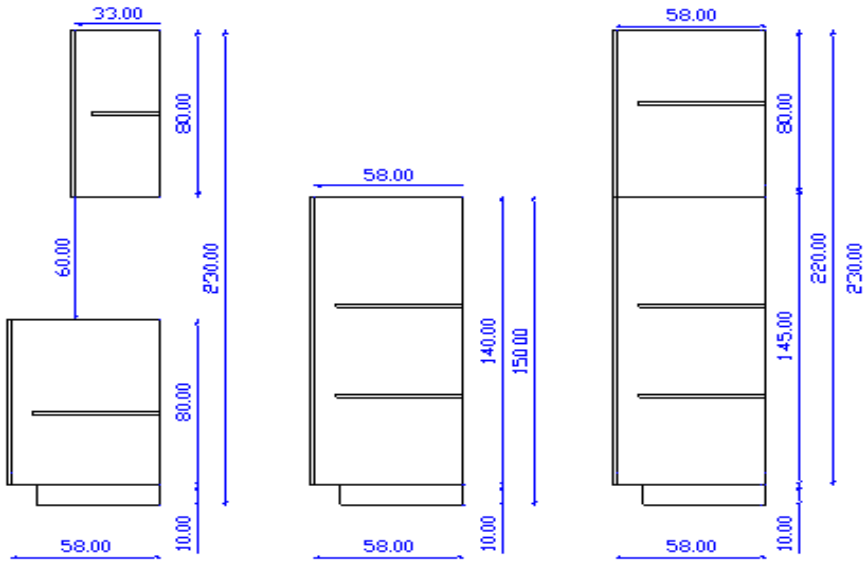

MODULOS
EXTRAPLANAS
ALTURA TOTAL :230

MODULOS
ALTO 70
ALTURA TOTAL :230

MODULOS
SEMICOLUMNAS
ALTURA TOTAL :230

MODULOS
COLUMNAS
ALTURA TOTAL :230

ALTURA TOTAL : 235

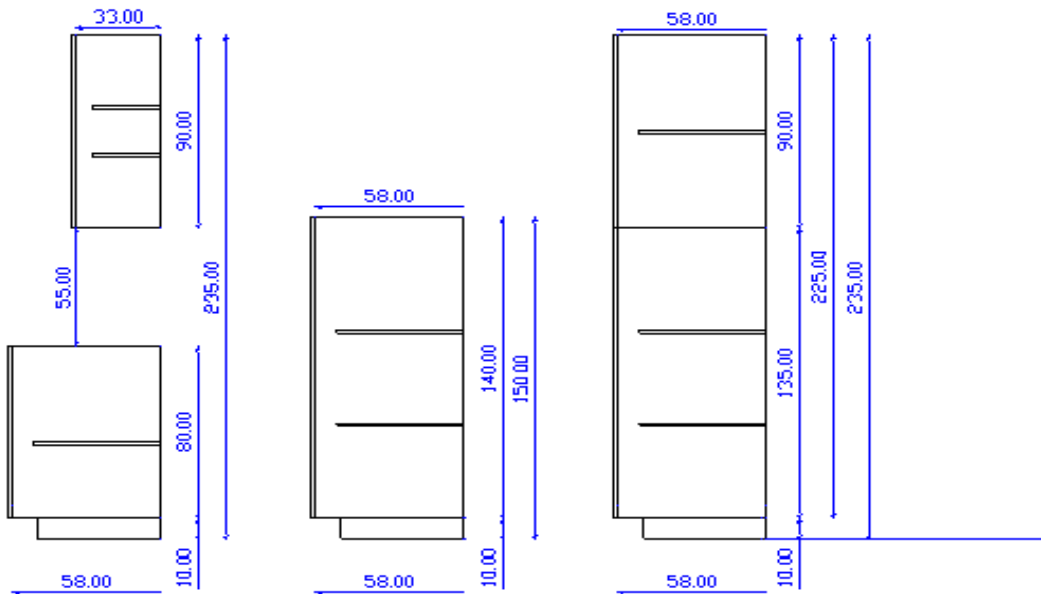

MODULOS
EXTRAPLANAS
ALTURA TOTAL :235

MODULOS
ALTO 90
ALTURA TOTAL :235

MODULOS
SEMICOLUMNAS
ALTURA TOTAL :235

MODULOS
COLUMNAS
ALTURA TOTAL :235

FORMATO PARA REALIZAR PEDIDOS

| CINCOCINA S.L. | |
|---|--|
| Ctra Ubeda-Malaga, Km, 37.300 23100 - MANCHA REAL (JAEN) TELF: 953 350 240 email: pedidos@cincocina.com www.cincocina.com | |

| | | |
|---------|--|----------|
| FECHA | | PEDIDO |
| CLIENTE | | |
| DIREC. | | TIRADOR: |
| POBL. | | |
| S/REF: | | |
| MODELO | | TARIFA |
| COLOR: | | |
| CANTO | | |

| L | CT | REFERENCIA | I-D | F.C. | COST.VIS. | T. | COLOR | DESCRIPCION |
|----|----|------------|-----|------|-----------|----|-------|-------------|
| 1 | | | | | | | | |
| 2 | | | | | | | | |
| 3 | | | | | | | | |
| 4 | | | | | | | | |
| 5 | | | | | | | | |
| 6 | | | | | | | | |
| 7 | | | | | | | | |
| 8 | | | | | | | | |
| 9 | | | | | | | | |
| 10 | | | | | | | | |
| 11 | | | | | | | | |
| 12 | | | | | | | | |
| 13 | | | | | | | | |
| 14 | | | | | | | | |
| 15 | | | | | | | | |
| 16 | | | | | | | | |
| 17 | | | | | | | | |
| 18 | | | | | | | | |
| 19 | | | | | | | | |
| 20 | | | | | | | | |

| COMPLEMENTOS | | | | | | | | |
|--------------|--|--|--|--|--|--|--|--|
| 1 | | | | | | | | |
| 2 | | | | | | | | |
| 3 | | | | | | | | |
| 4 | | | | | | | | |
| 5 | | | | | | | | |
| 6 | | | | | | | | |
| 7 | | | | | | | | |
| 8 | | | | | | | | |
| 9 | | | | | | | | |

| ELEMENTOS LINEALES | | | | | | |
|--------------------|-------------|----------|--|---------|------------|--|
| CT. | DESCRIPCION | MEDIDA | | | REFERENCIA | |
| | ENCIMERA | | | | | |
| | ENCIMERA | | | | | |
| | COPETE | | | | | |
| | ZOCALO | | | | | |
| | PERFIL ZOC. | | | | | |
| | J.UNION | J.TERM. | | J.EMP. | | |
| | TER.COP. | RINC.COP | | ES. COP | | |
| | PATAS | CHAPAS | | CLIP. | | |
| | Nº TIRADOR: | | | | | |
| | | | | | PRECIO : | |
| | | | | | | |